



Orthopaedics



Not all products illustrated in this documentation are available for sale in all countries. Please contact your local distributor for more information concerning availability and regulatory information (e.g. classification) of the mentioned products.

ORTHO PAEDICS

IMPLANTS AND INSTRUMENTS

Der Katalog "Orthopaedics" von Medicon bietet ein breites Spektrum an chirurgischen Instrumenten für die vielfältigen Indikationen bei der Behandlung von traumatischen Schädigungen des Knochenapparates oder Knochenfehlstellungen. Medicon liefert dafür Instrumente und Implantate -alles made in Germany- von bester Qualität unter Verwendung von international genormten hochwertigen Werkstoffen für die Orthopädie und Traumatologie.

Medicon's "Orthopaedics" catalogue offers a wide range of surgical instruments for multiple indications for treatment of traumatic injuries to the bone apparatus or bone adjustments. For this purpose Medicon supplies instruments and implants -all made in germany- of best quality using materials of international standards for Orthopaedics and Traumatology.

El catálogo "Orthopaedics" de Medicon ofrece un espectro muy amplio de instrumentos quirúrgicos para las múltiples indicaciones en la curación de daños traumáticos del aparato óseo o mal posición de los huesos. A este fin Medicon distribuye instrumentos e implantes - todo made in germany - de primera calidad de materia prima estandarizada según normas internacionales para la ortopedia y traumatología.

Le catalogue "Orthopaedics" de Medicon offre une large gamme d'instruments chirurgicaux permettant de traiter les dommages du squelette et d'intervenir lors d'interventions nécessitant un repositionnement osseux. Medicon délivre ainsi des instruments et des implants -tous made in Germany- de la meilleure qualité en utilisant des matériaux répondant aux normes de qualité internationales en vigueur pour l'orthopédie et la traumatologie.

Il catalogo di "Orthopaedics" della Medicon offre una ampia gamma di strumenti chirurgici per le varie indicazioni nel trattamento di lesioni traumatiche dell'apparato e delle malformazioni ossee. La Medicon fornisce per l'ortopedia e traumatologia strumenti ed impianti -tutto made in Germany- di ottima qualità utilizzando materie prime pregiate e standardizzate a livello internazionale.

medicon[®]

III CMF

Das Kompetenzfeld **CMF** kombiniert unsere modular aufgebauten Systeme für die Distraction und Osteosynthese in der kranio-maxillo-fazialen Chirurgie mit anwendungs-optimierten Lösungen und intuitiver Bedienbarkeit zu einem zukunfts-orientierten Konzept.

The competence field **CMF** combines our modular systems for distraction and osteosynthesis in cranio-maxillofacial surgery with application-optimised solutions and intuitive operation to produce a forward-looking concept.

II SURGICAL

Das Kompetenzfeld **SURGICAL** vernetzt unsere mehr als siebzigjährige Erfahrung als Medizintechnik-Unternehmen mit weit über 35.000 Produkten, die nahezu alle Indikationen der einzelnen chirurgischen Fachbereiche abdecken.

The competence field **SURGICAL** links our more than seventy years of experience as a medical technology company with over 35,000 products covering nearly all indications of the individual surgical specialty fields.

III NEURO+SPINE

Das Kompetenzfeld **NEURO+SPINE** konzentriert sich auf unser Produkt-Portfolio von qualitativ hochwertigen Instrumenten und innovativen Implantaten für die Neurochirurgie mit dem Fokus der produktbezogenen Spezialisierung als Grundlage einer transparenten Vertriebsstrategie.

The competence field **NEURO+SPINE** focuses on our product portfolio of high-quality instruments and innovative implants for neurosurgery with the main emphasis on product-related specialisation as a basis for a transparent sales strategy.

El área de especialización **CMF** combina nuestro sistema modular para la distensión y osteosíntesis en la cirugía cráneo-maxilofacial con soluciones orientadas a la aplicación y un manejo intuitivo para desarrollar un concepto enfocado hacia el futuro.

Le domaine de compétence **CMF** associe nos systèmes modulaires utilisés pour la distraction et ostéosynthèse en chirurgie crânio-maxillo-faciale à des solutions d'application optimisées et à une manipulation intuitive. Le résultat: Un concept d'avenir.

L'area di competenza **CMF** associa i nostri sistemi componibili per la distrazione e la osteosíntesi nella chirurgia cranio-maxillo-facciale a soluzioni ottimizzate nell'applicazione e manipolazione intuitiva, per un concetto orientato al futuro.

El área de especialización **SURGICAL** fusiona nuestros más de 70 años de experiencia como empresa de tecnología médica con más de 35.000 productos que cubren casi todas las indicaciones de cada una de las disciplinas quirúrgicas.

Le domaine de compétence **SURGICAL** allie notre expérience de plus de dix-sept ans dans le secteur des techniques médicales à plus de 35.000 produits, couvrant la quasi-totalité des indications de la chirurgie actuelle.

L'area di competenza **SURGICAL** collega la nostra ultrasettantennale esperienza aziendale nel campo della tecnica medica con oltre 35.000 prodotti che soddisfano quasi tutte le indicazioni delle singole aree di specializzazione chirurgiche.

El área de especialización **NEURO+SPINE** se centra en nuestra cartera de productos de instrumentos de alta calidad e implantes innovadores para la neurocirugía considerando la especialización relacionada con los productos como base de una estrategia de ventas transparente.

Le domaine de compétence **NEURO+SPINE** se concentre sur notre gamme d'instruments de grande qualité et d'implants novateurs pour la neurochirurgie, avec une spécialisation sur les produits comme base d'une stratégie de vente transparente.

L'area di competenza **NEURO+SPINE** si concentra sul nostro portfolio di strumenti di alta qualità e impianti innovativi per la neurochirurgia, e si propone come focus la specializzazione del prodotto come base di una trasparente strategia di distribuzione.

Der Ihnen vorliegende Katalog "Orthopaedics" bleibt unser Eigentum, auch wenn eine Leih- oder Schutzgebühr bezahlt wurde. Er darf nur zum Einkauf und Vertrieb der darin beschriebenen MEDICON-Produkte durch den dazu autorisierten Fachhandel und für die Bedarfsbeschaffung durch den jeweiligen Anwender verwendet werden. Seine Verwendung gegen unsere Interessen berechtigt uns zur sofortigen Rückforderung und möglichen weitergehenden Maßnahmen. Ohne unsere ausdrückliche, schriftliche Genehmigung darf dieser Katalog weder im Gesamten noch auszugsweise nachgedruckt oder kopiert werden.

This present "Orthopaedics" catalogue remains exclusively our property even if a lending fee or charge has been paid for it. It shall only be used by specialized dealers to buy and sell MEDICON products or by individual users to meet their own requirements. In case of misuse we are entitled to recall the catalogue immediately and to take further steps if necessary. It is not allowed to reprint or copy this catalogue in whole or in parts without our written permission.

El presente catálogo "Orthopaedics" sigue siendo nuestra propiedad aunque se ha pagado ciertos derechos de préstamo. Debe servir a los revendedores autorizados del ramo exclusivamente para la compra y la distribución de los productos MEDICON que describe, y a los especialistas y usuarios particulares para escoger los instrumentos necesarios para su abastecimiento. Su empleo abusivo en perjuicio de nuestros intereses, nos da derecho a exigir su devolución inmediata y a tomar todas las medidas ulteriores que juzguemos necesarias. Sin nuestro permiso expreso por escrito es prohibido reproducir o copiar este catálogo, tanto en su totalidad como en extractos.

Le présent catalogue "Orthopaedics" demeure notre propriété, même après acquittement d'une taxe autorisée ou taxe de prêt. Il ne peut être utilisé que pour l'achat ou la vente des produits MEDICON qui y sont décrits, par des spécialistes y étant autorisés et par l'utilisateur pour l'approvisionnement de ses besoins. Son utilisation contre nos intérêts nous autorise à une demande en restitution immédiate et à la prise éventuelle de mesures disciplinaires. Sans autorisation formelle écrite, ce catalogue ne peut être ni réimprimé, ni copié, que ce soit complètement ou partiellement.

Il presente catalogo "Orthopaedics" rimane di nostra proprietà anche se è stato pagato un diritto di noleggio o di proprietà riservata. Esso può essere adoperato soltanto per l'acquisto e la vendita dei prodotti MEDICON ivi descritti attraverso il commercio specializzato e autorizzato o per l'approvvigionamento tramite chi, di volta in volta, li impiega. L'uso del catalogo contro i nostri interessi ci autorizza al suo immediato ritiro e possibili ulteriori provvedimenti. Senza la nostra esplicita autorizzazione scritta questo catalogo non può essere ristampato o copiato nè integralmente nè parzialmente.

Modelländerungen vorbehalten
Patterns are subject to change without further notice
Salvo modificaciones
Tous droits réservés des changements de modèle
Ci riserviamo la facoltà di cambiamenti nei modelli



Für Druckfehler übernehmen wir keinerlei Haftung
We are not liable for misprints
Declinamos toda responsabilidad por los errores de impresión que pueda contener este documento
Nous déclinons toute responsabilité en cas d'erreurs d'impression
Non ci assumiamo nessuna responsabilità per eventuali errori di stampa

Gedruckt in Deutschland
Printed in Germany
Impreso en Alemania
Imprimé en Allemagne
Stampato in Germania
Trykket i Tyskland

© Copyright 06/2024, MEDICON eG, Tuttlingen, Germany

Implantate und Instrumente
Implants and Instruments
Implantes e instrumentos
Implants et instruments
Impianti e strumenti

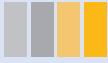
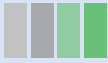
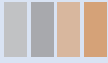
1 - 116

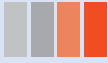
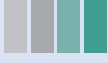
	<p>DHPS Platten / DHPS Set komplett DHPS Plates / DHPS Set complete Placas DHPS / DHPS Juego completo Plaques DHPS / DHPS Série complète Placche DHPS / DHPS Serie completa</p>	<p>1 - 12 / 292</p>
	<p>Minifragment / Minifragment-Set komplett Mini Fragment / Mini Fragment Set complete Mini fragmentos / Mini fragmentos juego completo Mini fragment / Mini fragments série complète Mini frammenti / Mini frammenti serie completa</p>	<p>13 - 40 / 293 - 295</p>
	<p>Titan Y–Radiusplatten Titanium Radius Plates Y–Shaped Placas radiales en forma de Y, titanio Plaques radius en forme de Y, titane Placche raggio a forma di Y, titanio</p>	<p>41 - 44</p>
	<p>Kleinfragment / Kleinfragment-Set komplett Small Fragment / Small Fragment Set complete Pequeño fragmento / Pequeño fragmento juego completo Petits fragments / Petits fragments série complète Frammento piccolo / Frammenti piccoli serie completa</p>	<p>45 - 60 / 296-297</p>
	<p>Großfragment / Großfragment-Set komplett Large Fragment / Large Fragment Set complete Fragmento grande / Fragmento grande juego completo Grande fragment / Grande fragment série complète Frammento grande / Frammento grande serie completa</p>	<p>61 - 84 / 298-300</p>
	<p>Rekonstruktion, Beckeninstrumentarium Reconstruction, Pelvic Instrumentation Reconstrucción, Instrumental para pelvis Reconstruction, Instruments pelvins Ricostruzione, Strumenti pelvici</p>	<p>85 - 102</p>
	<p>Kanülierte Schrauben Cannulated Screws Tornillos canulados Vis cannulées Viti cannulate</p>	<p>103 - 116</p>

Standardinstrumente
Basic Instruments
Instrumentos básicos
Instruments de base
Strumenti di base

117 - 212

<p>Knochenfeilen Bone Files Limas para huesos Limes à os Lime per ossa</p>	<p>118 - 120</p>
<p>Elevatorien Elevators Elevadores Elévateurs Elevatori</p>	<p>121 - 123</p>

Raspatorien Raspatories Legras Rugines Periostotomi	124 - 138
Hämmer Mallets Martillos Maillets Martelli	139 - 144
Flachmeißel, Hohlmeißel Chisels, Gouges Cinceles, Gubias Ciseaux burins, Ciseaux gouges ScalPELLI, Sgorbie	145 - 162
Scharfe Löffel Sharp Curettes Cucharillas cortantes Curettes tranchantes Cucchiai taglianti	163 - 173
Hohlmeißelzangen Bone Rongeurs Pinzas-gubias Pinces-gouges Pinze sgorbie	174 - 185
Knochensplitterzangen Bone Cutting Forceps Pinzas cortantes para huesos Pinces coupantes à os Pinze ossivore	186- 189
Knochenhalte­zangen, Repositionszangen Bone Holding Forceps, Reposition Forceps Pinzas prensoras de huesos, Pinzas para reposición Daviers à os, Pinces à réposition Tenaglie per ossa, Pinze per riposizione	190 - 199
Knochenbohrer, Reibahlen Bone Drill, Reamers Taladro para huesos, Escariadores Perforateur à os, Alésoirs à main Perforatore per ossa, Alesatori	200
Knochenhebel Bone Levers Elevadores para hueso Leviers à os Elevatori per ossa	201 - 208
Schraubendreher Screwdriver Atornilladores Tournevis Cacciavite	209 - 210
Messinstrumente Measuring Instruments Instrumentos de medida Instruments de mesure Strumenti per misurazione	211 - 212

Marknagelung Intramedullary Nailing Clavos medulares Clous médullaires Chiodi midollari	213 - 218
Draht und Drahtinstrumente Wire and Wire Instruments Alambre e instrumentos para alambre Fils et instruments pour fils métalliques Fili d'acciaio e strumenti per fili d'acciaio	219 - 248
Kirschnerdrähte Kirschner Wires Kirschner brocas Kirschner broches Kirschner fili perforatori	220 - 221
Steinmann Nägel Steinmann Nails Steinmann clavos Steinmann clous Steinmann chiodi	222 - 224
Schanz Schrauben Schanz Screws Schanz tornillos Schanz vis Schanz viti	224
Drahtextension Wire Traction Extensión de alambre Extension de fils d'acier Trazione a fili d'acciaio	225 - 230
Knochendrähte, Handbohrer Bone Wires, Hand Drills Hilos para huesos, Perforadoras Fils à os, Perforateurs Fili per ossa, Perforatori	231
Drahtumführungsadeln Wire Guides Needles Agujas conductoras de alambre Passe-fils Aghi passafilo	232 - 233
Drahtzangen Wire Forceps Pinzas para alambres Pincés à fils Pinze per fili	234 - 240
Drahtscheren · Kneifzangen Wire Cutting Scissors · Wire Cutting Pliers Tijeras para cortar alambre · Pinzas para cortar alambre Ciseaux coupe-fil · Pincés coupe fil Forbici per fili d'acciaio · Tenaglie taglia fili	241 - 248

Knochenklammern und Instrumente Bone Staples and Instruments Grapas para hueso y instrumentos Agrafes à os et instruments Agrafes per ossa e strumenti	249 - 251
Amputation Amputation Amputación Amputation Amputazione	253 - 260
Verband- und Gipsinstrumente Bandage and Plaster Instruments Instrumentos para vendajes e yeso Instrumentes à pansements et à plâtre Strumenti per bendaggi e per gesso	261 - 272
Motor-Systeme und Handbohrapparate Motor Systems and Hand Drills Sistemas de motores y perforadores de mano Systèmes de moteurs et perforateurs à main Sistemi de motore e trapani a mano	273 - 289
Verbandsägen Plaster Saws Sierras para vendajes Scies à plâtre Sega per gessi	274 - 281
Handbohrapparate Hand Drills Perforadores de mano Perforateurs à main Trapani a mano	283 - 289
Siebvorschläge Set Suggestions Proposiciones de juegos Propositions pour boîtes Proposte di sets	301 - 335
Index Index Indice Index Indice	337 - 378
Alphabetischer Index Alphabetical Index Indice alfabético Index alphabétique Indice alfabetico	338 - 362
Numerischer Index Numerical Index Indice numérico Index numérique Indice numerico	363 - 377

Systemübersicht
System Overview
Vista general al sistema
Aperçu général du système
Visione generale del sistema



DHPS-PLATES



MINI FRAGMENT



TITANIUM RADIUS PLATES Y-SHAPED



SMALL FRAGMENT



LARGE FRAGMENT



PELVIS · RECONSTRUCTION



CANNULATED SCREWS

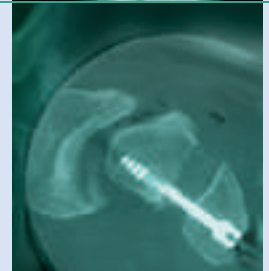
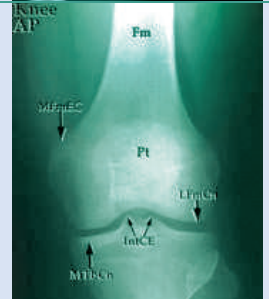

Hinweise
Indications
Indicaciones
Indications
Indicazioni

Unsere Instrumenten-Abbildungen haben eine Größe von ca. 50 %. Andere Darstellungsgrößen werden im Maßstab (zum Beispiel 1:1) angegeben. Die dazugehörigen Detailbilder sind in Originalgröße (100 %) abgebildet. Die angegebenen Bemaßungen unterliegen herstellungsbedingt einer Fertigungstoleranz.

In general the instrument illustrations are scaled to be approximately 50 % of actual size. If other scales are used they are indicated (for example 1:1). The corresponding detailed tip illustrations are shown in actual size (100 %). The stated measurements may have a slight variation in permissible tolerances due to minor variations in manufacturing conditions.

Las ilustraciones de los instrumentos tienen un tamaño de aprox. 50 %. Otros tamaños de las ilustraciones serán indicados con la indicación de una escala (por ejemplo 1:1). Los imagenes detallados pertinentes son en su tamaño original (100 %). Las dimensiones indicadas son sujeto de tolerancias.



Les illustrations de nos instruments sont à 50 % de la taille réelle. D'autres dimensions de représentation sont données avec indication d'échelle (par exemple 1:1). Les images de détail sont projetées en grandeur réelle (100 %). Toutes les dimensions données ont une tolérance de fabrication.

Le illustrazioni dei nostri strumenti hanno una dimensione del 50 %. Altre dimensioni di raffigurazione sono segnate con una scala (per esempio 1:1). Le relative illustrazioni dettagliate sono illustrate in dimensioni originali (100 %). Le dimensioni indicate sono soggette a una tolleranza di fabbricazione.

Beispiel
Example
Ejemplo
Exemple
Esempio

Vorderansicht (Schere gerade)
 Front view (straight scissors)
 Vista frontal (tijera recta)
 Vue de face (ciseaux droits)
 Vista frontale (forbice retta)

Seitenansicht (Schere gebogen)
 Lateral view (curved scissors)
 Vista lateral (tijera curva)
 Vue laterale (ciseaux courbes)
 Vista laterale (forbice curvata)

		
	9 cm - 3 1/2"	9 cm - 3 1/2"
supercut	204.32.09	204.33.09
black line	214.32.09	214.33.09

Mini-Metzenbaum

Instrumentengröße
 Instrument size
 Tamaño del instrumento
 Taille des instruments
 Misura degli strumenti

Artikelnummer
 Item number
 Número de artículo
 Numéro d'article
 Codice dell'articolo

PROPYLUX



- ▶ Ein biokompatibler Kunststoff der neuesten Thermoplast-Generation
- ▶ Extrem formbeständig bei häufiger Autoklavierung
- ▶ A biocompatible plastic from the latest generation of thermoplastics
- ▶ Extremely high dimensional stability with frequent autoclaving
- ▶ Un plástico biocompatible de la última generación de termoplásticos
- ▶ Extremadamente resistente a deformaciones en esterilizaciones en autoclave frecuentes
- ▶ Un plastique biocompatible de la toute dernière génération des thermoplastiques
- ▶ Extrêmement résistant aux déformations en cas de passages fréquents à l'autoclave
- ▶ Una plastica biocompatibile della più recente generazione di termoplastiche
- ▶ Estremamente resistente a deformazioni anche con trattamento frequente in autoclave

NOVOTEX



- ▶ Ein duroplastischer Kunststoff aus der Familie der Phenoplaste
- ▶ Sehr hart und bruchbeständig
- ▶ Thermosetting plastics of the phenol formaldehyde resins family
- ▶ Very hard and break resistant
- ▶ Plástico termoendurecible de la familia de resina fenol-formaldehído
- ▶ Muy duro y resistente a la rotura
- ▶ Plastique thermodurcissable de la famille des résines phénol-formaldéhyde
- ▶ Très dur et résistant à la casse
- ▶ Materia plastica termoindurente della famiglia di resine fenoliche
- ▶ Molto duro e resistente alla rottura



ORTHO PAEDICS

IMPLANTS AND INSTRUMENTS

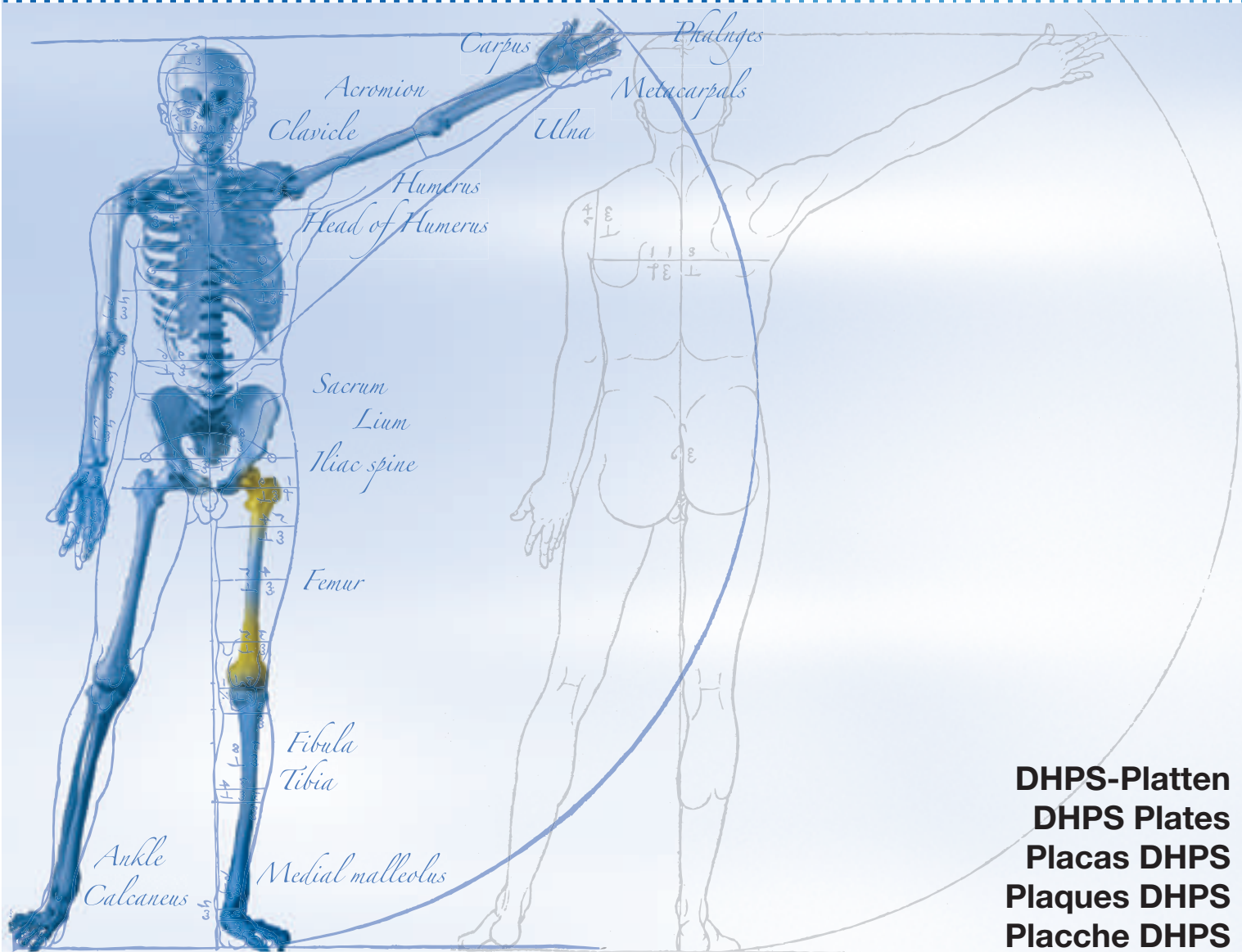

DHPS-Platten
DHPS Plates
Placas DHPS
Plaques DHPS
Placche DHPS



DHPS-Platten
DHPS Plates
Placas DHPS
Plaques DHPS
Placche DHPS

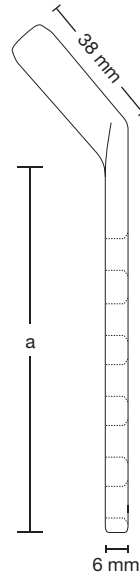
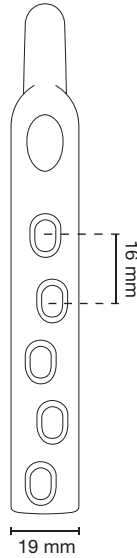

Zylinderlänge 38 mm
 Length of cylinder 38 mm
 Largo de cilindro 38 mm
 Longueur de cylindre 38 mm
 Lunghezza del cilindro 38 mm

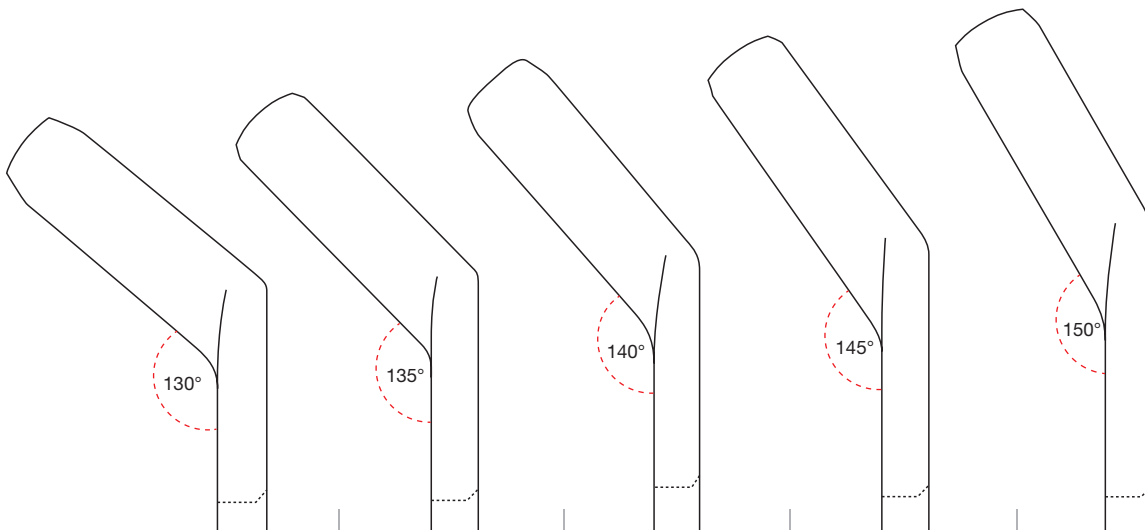

					a	(x)
708.30.02	708.35.02	708.40.02	708.45.02	708.50.02	46 mm	2
708.30.03	708.35.03	708.40.03	708.45.03	708.50.03	62 mm	3
708.30.04	708.35.04	708.40.04	708.45.04	708.50.04	78 mm	4
708.30.05	708.35.05	708.40.05	708.45.05	708.50.05	94 mm	5
708.30.06	708.35.06	708.40.06	708.45.06	708.50.06	110 mm	6
708.30.08	708.35.08	708.40.08	708.45.08	708.50.08	142 mm	8
708.30.10	708.35.10	708.40.10	708.45.10	708.50.10	174 mm	10
708.30.12	708.35.12	708.40.12	708.45.12	708.50.12	206 mm	12
708.30.14	708.35.14	708.40.14	708.45.14	708.50.14	238 mm	14

(x) Anzahl der Löcher
 Number of holes
 Número de los orificios
 Nombre de trous
 Numero di fori

DHPS-Platten
DHPS Plates
Placas DHPS
Plaques DHPS
Placche DHPS

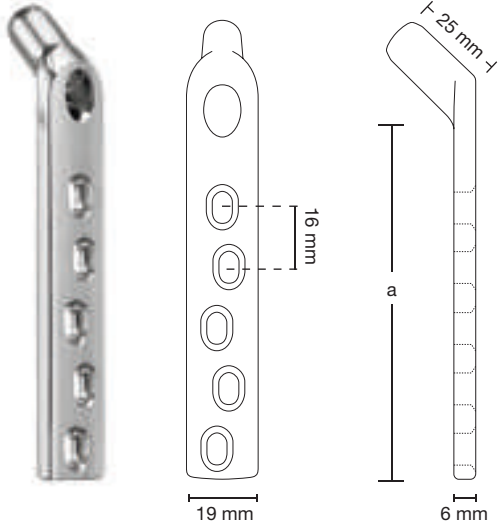

Zylinderlänge 25 mm
 Length of cylinder 25 mm
 Largo de cilindro 25 mm
 Longueur de cylindre 25 mm
 Lunghezza del cilindro 25 mm

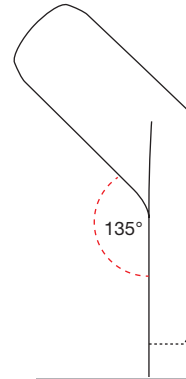

	a	(x)
708.25.04	78 mm	4
708.25.05	94 mm	5
708.25.06	110 mm	6

Suprakondyläre Platten
 Supra condilar plates
 Placas supra condilares
 Plaques supra-condilaires
 Placche supra condilare

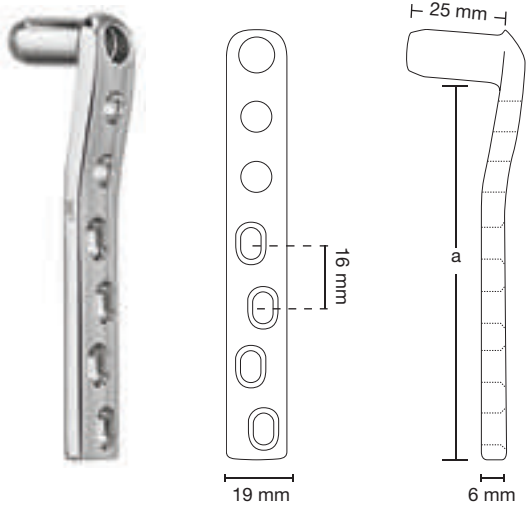

Zylinderlänge 25 mm
 Length of cylinder 25 mm
 Largo de cilindro 25 mm
 Longueur de cylindre 25 mm
 Lunghezza del cilindro 25 mm

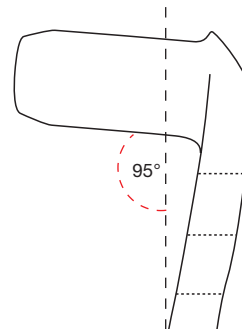

	a	(x)
708.95.06	112 mm	6
708.95.08	144 mm	8
708.95.10	176 mm	10
708.95.12	208 mm	12
708.95.14	240 mm	14
708.95.16	272 mm	16

(x) Anzahl der Löcher
 Number of holes
 Número de los orificios
 Nombre de trous
 Numero di fori



DHPS-Schrauben
DHPS Screws
Tornillos DHPS
Vis DHPS
Viti DHPS



1:1

Zugschrauben
 Traction screws
 Tornillos de tracción
 Vis à traction
 Viti di trazione

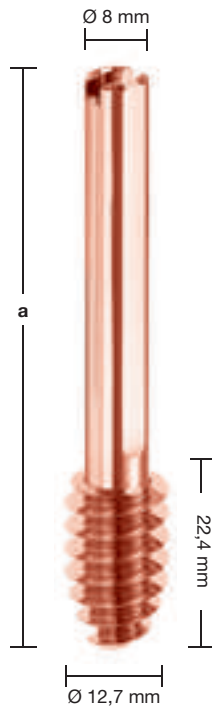

	a
708.00.01	50 mm
708.00.02	55 mm
708.00.03	60 mm
708.00.04	65 mm
708.00.05	70 mm
708.00.06	75 mm
708.00.07	80 mm
708.00.08	85 mm
708.00.09	90 mm
708.00.10	95 mm
708.00.11	100 mm
708.00.12	105 mm
708.00.13	110 mm
708.00.14	115 mm
708.00.15	120 mm
708.00.16	125 mm
708.00.17	130 mm
708.00.18	135 mm
708.00.19	140 mm
708.00.20	145 mm



1:1

Kompressionsschraube
 Compression screw
 Tornillo para compresión
 Vis à compression
 Vite di compressione

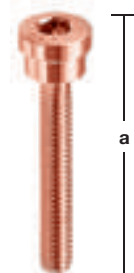

	a
708.00.00	36 mm

Weitere Knochenschrauben für DHPS-Platten – 4,5 mm Kortikalis und 6,5 mm Spongiosa siehe Seiten 71 - 73
 Further bone screws for DHPS plates – 4,5 mm cortical and 6,5 mm spongiosa see page 71 - 73
 Tornillos para huesos para placas DHPS – 4,5 mm cortical y 6,5 mm esponjosa veáse página 71 - 73
 Des vis à os pour les plaques DHPS – 4,5 mm corticales et 6,5 mm spongieuses voir page 71 - 73
 Altre viti per ossa per le placche DHPS – 4,5 mm corticale e 6,5 mm spongiosa vedete a pagina 71 - 73

DHPS-Instrumentarium
DHPS Instrumentation
Instrumental DHPS
Instruments DHPS
Strumenti DHPS



Zielgerät
 Drill guide
 Aparato de punteria
 Guide
 Mirino

justierbar
 adjustable
 ajustable
 ajustable
 aggiustabile

708.01.00

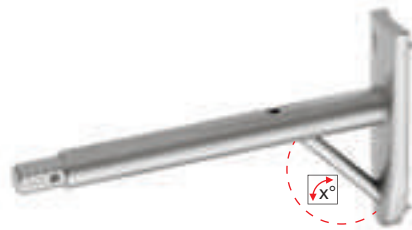

Zielgeräte
 Drill guides
 Aparatos de punteria
 Guides
 Mirini



708.01.01	130°
708.01.02	135°
708.01.03	140°
708.01.04	145°
708.01.05	150°



Zielgerät
 Drill guide
 Aparato de punteria
 Guide
 Mirino

für suprakondyläre Platten
 for supra condilar plates
 para placas supra condilares
 pour plaques supra-condilaires
 per placche supra condilare

708.01.06

95°



DHPS-Instrumentarium
DHPS Instrumentation
Instrumental DHPS
Instruments DHPS
Strumenti DHPS

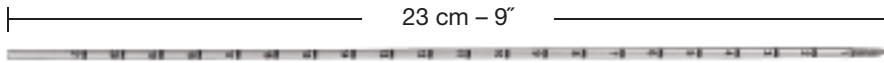

Führungsdraht
 Guide wire
 Hilo conductor
 Guide broche
 Filo guida

	Ø
708.01.07	2,5 mm



Tiefenlehre
 Depth gauge
 Calibre de profundidad
 Guide de profondeur
 Calibro di profondità

708.01.08	
------------------	--



Dreistufenbohrer
 Three-step reamer
 Broca tres escalones
 Triple foret
 Perforatore a tre livelli

708.01.09	
------------------	--

für Standard DHPS-Platten
 for standard DHPS plates
 para placas estándar DHPS
 pour plaques standard DHPS
 per placche standard DHPS



Dreistufenbohrer
 Three-step reamer
 Broca de tres escalones
 Triple foret
 Perforatore a tre livelli

708.01.10	
------------------	--

für Suprakondylär DHPS-Platten
 for supra condilar DHPS plates
 para placas supra condilares DHPS
 pour plaques supra condilaires DHPS
 per placche supra condilare DHPS

DHPS-Instrumentarium
DHPS Instrumentation
Instrumental DHPS
Instruments DHPS
Strumenti DHPS

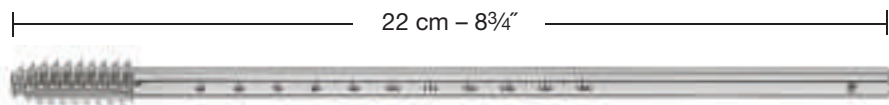

Gewindeschneider
 Tap
 Roscador
 Taraud
 Filettatore

	Ø
708.01.11	12,5 mm



T-Griff, groß, mit Schnellkupplung
 T-Handle, large, with quick coupling
 Mango en T, grande, con acoplamiento rápido
 Manche en T, large, avec accouplement rapide
 Manico a T, grande, con accoppiamento rapido

708.01.12	
------------------	--



Zentrierhülse, kurz
 Centering sleeve, short
 Vaina para centrar, corta
 Douille pour centrer, courte
 Boccia di centraggio, corta

708.01.17	
------------------	--



DHPS-Instrumentarium
DHPS Instrumentation
Instrumental DHPS
Instruments DHPS
Strumenti DHPS



Zentrierhülse, lang
Centering sleeve, long
Vaina para centrar, grande
Douille pour centrer, longue
Boccola di centraggio, lunga

708.01.18

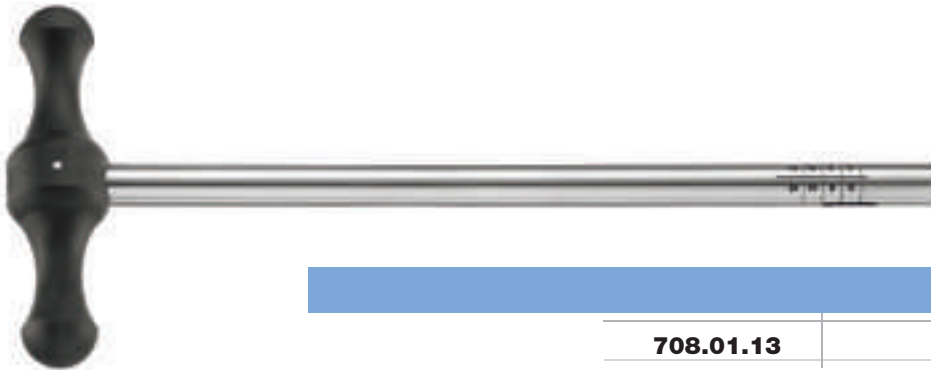

Schlüssel mit T-Griff für DHPS-Schrauben
Wrench with T-handle for DHPS screws
Llave con mango en T para tornillos DHPS
Clé avec manche en T pour vis DHPS
Chiave con manico a T per viti DHPS

708.01.13



Verbindungsschraube, lang
Coupling screw, long
Tornillo de conexion, grande
Vis de jonction, longue
Vite di raccordo, lunga

708.01.16



DHPS-Instrumentarium
DHPS Instrumentation
Instrumental DHPS
Instruments DHPS
Strumenti DHPS



Verbindungsschraube, kurz
 Coupling screw, short
 Tornillo de conexion, corto
 Vis de jonction, courte
 Vite di raccordo, corta

708.01.14



Führungsschaft
 Guide shaft
 Vaina de guía
 Tige guide
 Guida

708.01.15



Einschlaginstrument
 Impactor
 Impactor
 Impacteur
 Introduttore

708.01.19



DHPS-Instrumentarium
DHPS Instrumentation
Instrumental DHPS
Instrumenti DHPS



Bohrer mit Schnellkupplung
 Drills with quick coupling
 Brocas con acoplamiento rápido
 Forets avec accouplement rapide
 Perforatori con accoppiamento rapido

	a	Ø
709.30.23	75 mm	2,0 mm
711.30.18	120 mm	3,2 mm
711.30.20	120 mm	4,5 mm



Gewindeschneider
 Taps
 Roscadores
 Tarauds
 Filettatori

	a	Ø
für Kortikalisschrauben for cortical screws para tornillos corticales pour vis corticales per viti corticalis	711.30.29	125 mm 4,5 mm
	711.30.30	200 mm 6,5 mm



Doppelbohrbuchse
 Double drill sleeve
 Casquillo de taladrar doble
 Double douille de forage
 Centrapunta doppia

711.30.09	Ø 6,5 mm	Ø 3,2 mm
------------------	----------	----------

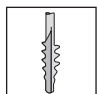

für Gewindeschneider
 for taps
 para roscadores
 pour tarauds
 per filettatori



für Bohrer
 for drills
 para brocas
 pour forets
 per perforatori

DHPS-Instrumentarium
DHPS Instrumentation
Instrumental DHPS
Instruments DHPS
Strumenti DHPS



Universalbohrbuchse
 Universal drill sleeve
 Casquillo de taladrar universal
 Douille de forage universel
 Centrapunta universale

711.30.10		
	Ø 4,5 mm	Ø 3,2 mm



T-Griff, klein, mit Schnellkupplung
 T-Handle, small, with quick coupling
 Mango en T, pequeño, con acoplamiento rápido
 Manche en T, petit, avec accouplement rapide
 Manico a T, piccolo, con accoppiamento rapido

711.30.12

3,5 mm



Schraubendreher Sechskant
 Screwdriver hexagonal
 Atornillador hexagonal
 Tournevis hexagonal
 Cacciavite esagonale

	711.30.15	24,5 cm - 9¾"
--	------------------	---------------



für Gewindeschneider
 for taps
 para roscadores
 pour tarauds
 per filettatori



für Bohrer
 for drills
 para brocas
 pour forets
 per perforatori



Kunststoffgriff (autoklavierbar bis 134 °C bei 3 bar)
 Plastic handle (autoclavable up to 134 °C at 3 bar)
 Mango de plástico (autoclavable hasta 134 °C bajo presión de 3 bar)
 Manche en plastique (autoclavable à 134 °C sous pression de 3 bars)
 Manico di plastica (autoclavabile fino a 134 °C sotto pressione di 3 bar)



DHPS-Instrumentarium
DHPS Instrumentation
Instrumental DHPS
Instruments DHPS
Strumenti DHPS



Haltehülse
Holding sleeve
Vaina
Douille
Boccola

für Schrauben Ø 4,5 / 6,5 / 7,0 mm
for screws Ø 4,5 / 6,5 / 7,0 mm
para tornillos Ø 4,5 / 6,5 / 7,0 mm
pour vis Ø 4,5 / 6,5 / 7,0 mm
per viti Ø 4,5 / 6,5 / 7,0 mm

711.30.17



Schraubenhaltepinzette
Screw holding forceps
Pinza para agarrar tornillos
Pince pour tenir les vis
Pinza per tenere viti

709.30.40



Bohrlochtiefenlehre, groß
Depth gauge for drill-holes, large
Instrumento para medir la profundidad, grande
Instrument pour mesurer la profondeur, grand
Strumento per misurare la profondità, grande

für Schrauben Ø 4,5 / 6,5 mm
for screws Ø 4,5 / 6,5 mm
para tornillos Ø 4,5 / 6,5 mm
pour vis Ø 4,5 / 6,5 mm
per viti Ø 4,5 / 6,5 mm

711.30.06

ORTHO PAEDICS

IMPLANTS AND INSTRUMENTS

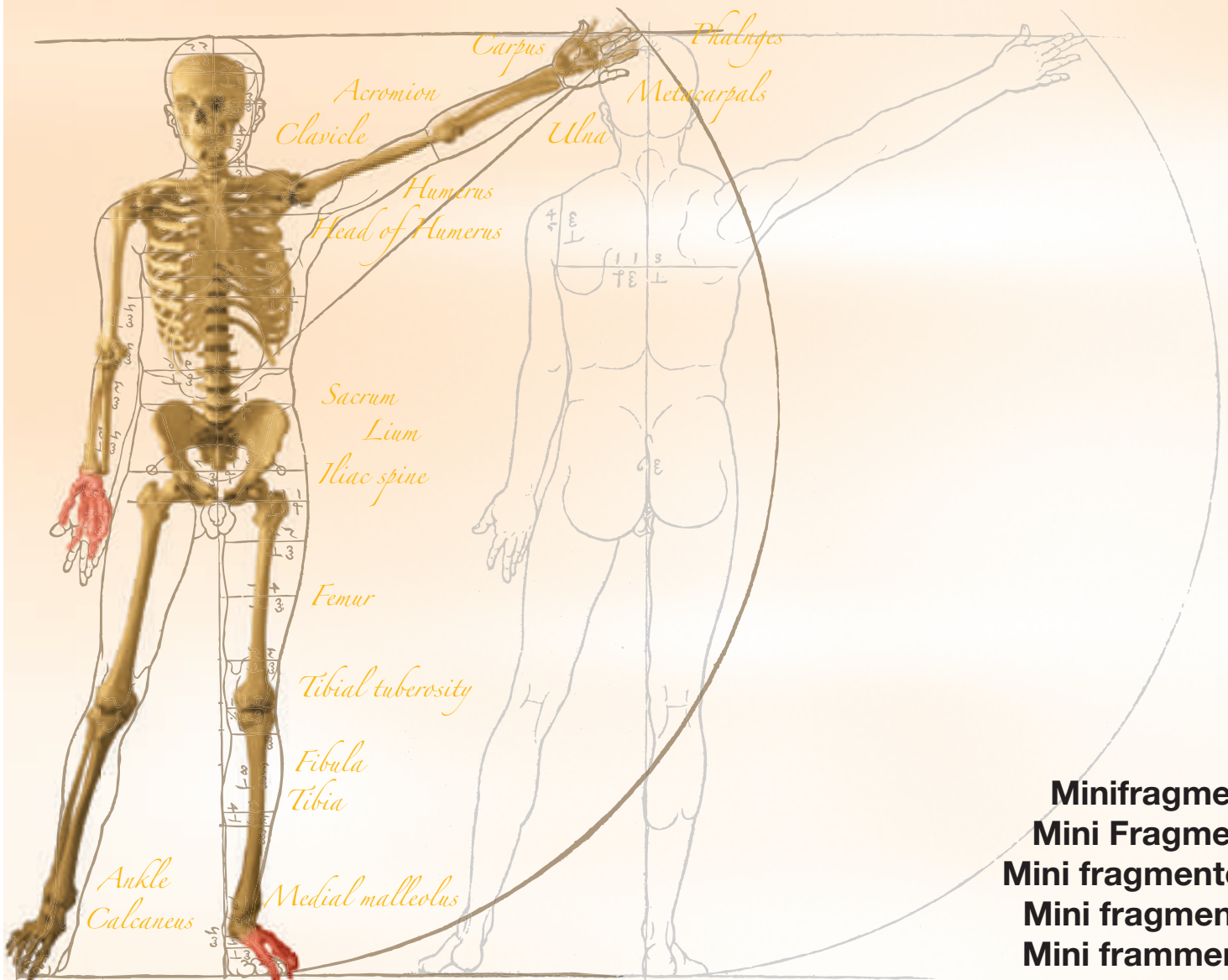

Minifragment
Mini Fragment
Mini fragmentos
Mini fragments
Mini frammenti

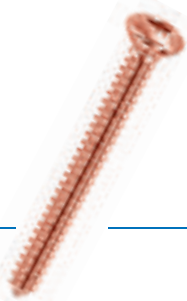

Minifragmentplatten
Mini Fragment Plates
Placas para mini fragmentos
Plaques pour mini fragments
Placche per mini frammenti

1.5

für Kortikalisschrauben **1,5 mm**
 for cortical screws **1,5 mm**
 para tornillos corticales **1,5 mm**
 pour vis corticales **1,5 mm**
 per viti corticalis **1,5 mm**

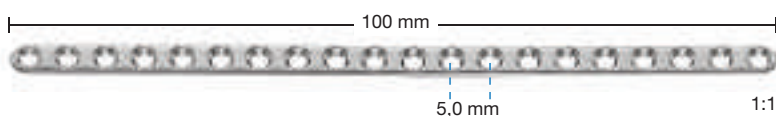

Kompressionsplatte
 Compression plate
 Placa de compression
 Plaque de compression
 Placca di compressione

		709.00.20	(20)

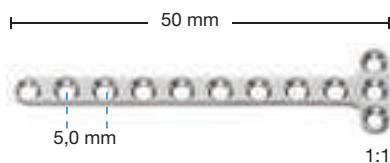

T-Platten
 T-Plates
 T-Placas
 T-Plaques
 T-Placche

		b	
		709.01.02	12 mm (9) × (3)
		709.01.03	16 mm (9) × (4)



H-Platte
 H-Plate
 H-Placa
 H-Plaque
 H-Placca

		709.02.04	(4)

	Plattendicke Thickness of plates Grosor de las placas Epaisseur des plaques Spessore delle placche
--	--

	Plattenbreite Width of plates Ancho de la placa Largeur des plaques Larghezza delle placche
--	---

	Anzahl der Löcher Number of holes Número de los orificios Nombre de trous Numero di fori
--	--



1.5

Minifragmentplatten
Mini Fragment Plates
Placas para mini fragmentos
Plaques pour mini fragments
Placche per mini frammenti

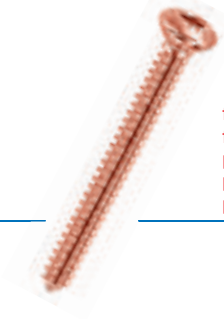

für Kortikalisschrauben **1,5 mm**
 for cortical screws **1,5 mm**
 para tornillos corticales **1,5 mm**
 pour vis corticales **1,5 mm**
 per viti corticalis **1,5 mm**

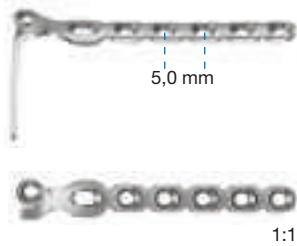

1:1

Kondylenplatte
 Condylar plate
 Placa condilar
 Plaque condyilaire
 Placca condilica

	709.03.05	6
Stift links Pin left Pin izquierda Pointe gauche Perno sinistra		

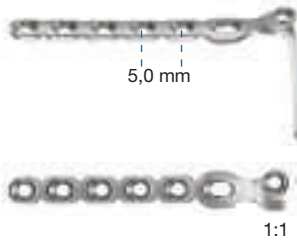

1:1

Kondylenplatte
 Condylar plate
 Placa condilar
 Plaque condyilaire
 Placca condilica

	709.03.06	6
Stift rechts Pin right Pin derecha Pointe droite Perno destra		

	Plattendicke Thickness of plates Grosor de las placas Epaisseur des plaques Spessore delle placche
--	--

	Plattenbreite Width of plates Ancho de la placa Largeur des plaques Larghezza delle placche
--	---

	Anzahl der Löcher Number of holes Número de los orificios Nombre de trous Numero di fori
--	--

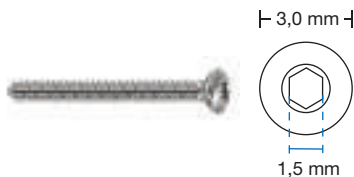
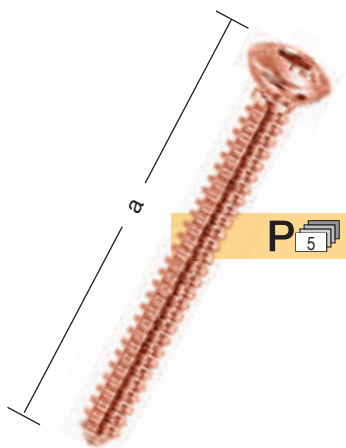

Minifragmentschrauben
Mini Fragment Screws
Tornillos para mini fragmentos
Vis pour mini fragments
Viti per mini frammenti

1.5

Kortikalisschrauben **1,5 mm**
 Cortical screws **1,5 mm**
 Tornillos corticales **1,5 mm**
 Vis corticales **1,5 mm**
 Viti corticalis **1,5 mm**

P₅

a

709.15.01	6 mm
709.15.02	7 mm
709.15.03	8 mm
709.15.04	9 mm
709.15.05	10 mm
709.15.06	11 mm
709.15.07	12 mm
709.15.08	14 mm
709.15.09	16 mm
709.15.10	18 mm
709.15.11	20 mm



1,5 mm



1,0 mm

Bohrer für Gewindeloch 1,1 mm siehe Seite 27
 Drills for threaded hole 1,1 mm see page 27
 Brocas para orificio roscado 1,1 mm vea la página 27
 Forets pour trou fileté de 1,1 mm voir page 27
 Perforatori per foro filettato 1,1 mm vedi pagina 27

Gewindeschneider 1,5 mm siehe Seite 27
 Taps 1,5 mm see page 27
 Roscadores 1,5 mm veáse página 27
 Tarauds 1,5 mm voir page 27
 Filettatori 1,5 mm vedete pagina 27

Bohrer für Gleitloch 1,5 mm siehe Seite 27
 Drills for sliding hole 1,5 mm see page 27
 Brocas para orificio de deslizamiento 1,5 mm vea la página 27
 Forets pour trou lisse de 1,5 mm voir page 27
 Perforatori per foro di scorrimento 1,5 mm vedi pagina 27



Unterlegscheibe für Kortikalisschrauben 1,5 mm
 Washer for cortical screws 1,5 mm
 Arandela para tornillos corticales 1,5 mm
 Rondelle pour vis corticales 1,5 mm
 Rondella per viti corticalis 1,5 mm

P₅**709.00.00**

Verpackungseinheit "X" Stück
 Packing unit "X" pieces
 Paquete de "X" unidades
 Emballage de "X" pièces
 Confezione da "X" pezzi



2.0

Minifragmentplatten
Mini Fragment Plates
Placas para mini fragmentos
Plaques pour mini fragments
Placche per mini frammenti

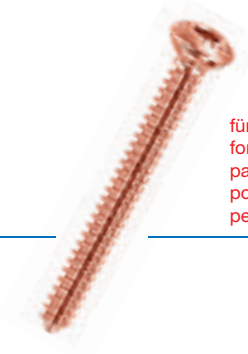

für Kortikalisschrauben **2,0 mm**
 for cortical screws **2,0 mm**
 para tornillos corticales **2,0 mm**
 pour vis corticales **2,0 mm**
 per viti corticalis **2,0 mm**

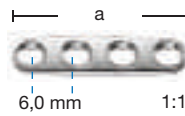

Kompressionsplatten
 Compression plates
 Placas de compresion
 Plaques de compression
 Placche di compressione

		a	
		709.04.03	17 mm (3)
		709.04.04	22 mm (4)
		709.04.05	27 mm (5)
		709.04.06	32 mm (6)

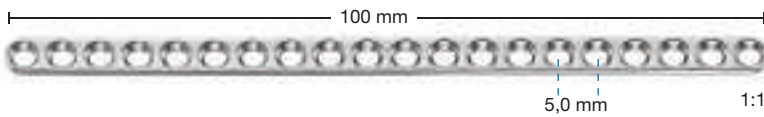

Kompressionsplatte
 Compression plate
 Placa de compresion
 Plaque de compression
 Placca di compressione

		709.04.20	(20)

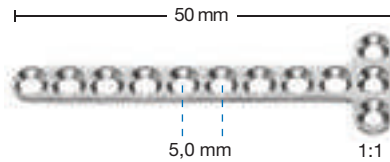

T-Platten
 T-Plates
 T-Placas
 T-Plaques
 T-Placche

		b	
		709.05.00	15 mm (9 × 3)
		709.05.01	20 mm (9 × 4)

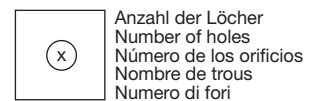
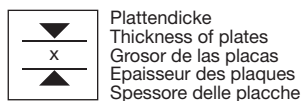

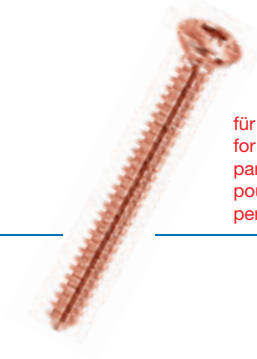

Minifragmentplatten
Mini Fragment Plates
Placas para mini fragmentos
Plaques pour mini fragments
Placche per mini frammenti

2.0

für Kortikalisschrauben **2,0 mm**
 for cortical screws **2,0 mm**
 para tornillos corticales **2,0 mm**
 pour vis corticales **2,0 mm**
 per viti corticalis **2,0 mm**

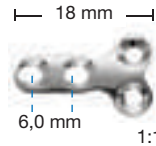

T-Platte
 T-Plate
 T-Placa
 T-Plaque
 T-Placca

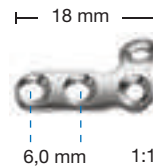
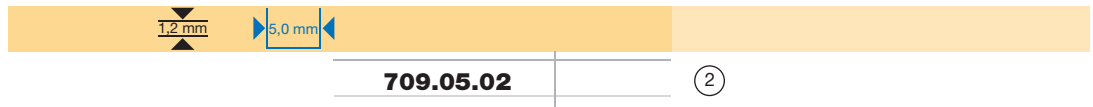

L-Platte 90°
 L-Plate 90°
 L-Placa 90°
 L-Plaque 90°
 L-Placca 90°

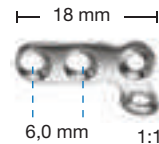
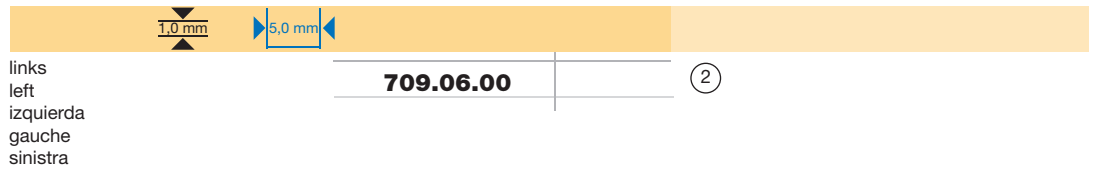

L-Platte 90°
 L-Plate 90°
 L-Placa 90°
 L-Plaque 90°
 L-Placca 90°

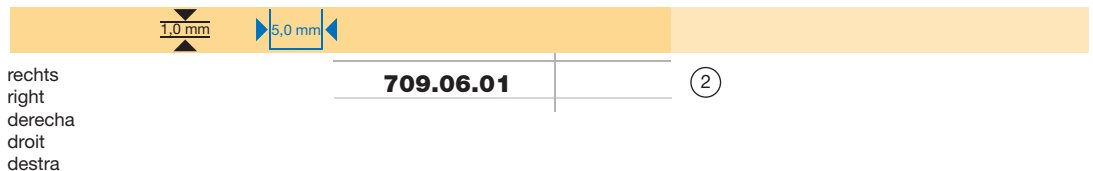

 Plattendicke
 Thickness of plates
 Grosor de las placas
 Epaisseur des plaques
 Spessore delle placche

 Plattenbreite
 Width of plates
 Ancho de la placa
 Largeur des plaques
 Larghezza delle placche

 Anzahl der Löcher
 Number of holes
 Número de los orificios
 Nombre de trous
 Numero di fori



2.0

Minifragmentplatten
Mini Fragment Plates
Placas para mini fragmentos
Plaques pour mini fragments
Placche per mini frammenti

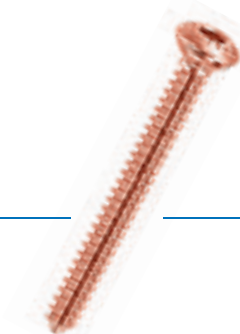

für Kortikalisschrauben 2,0 mm
 for cortical screws 2,0 mm
 para tornillos corticales 2,0 mm
 pour vis corticales 2,0 mm
 per viti corticalis 2,0 mm

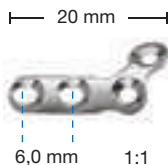

L-Platte schräg
 L-Plate oblique
 L-Placa oblicua
 L-Plaque oblique
 L-Placca obliqua



links
 left
 izquierda
 gauche
 sinistra

709.07.00

②

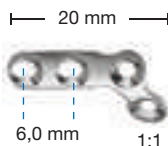

L-Platte schräg
 L-Plate oblique
 L-Placa oblicua
 L-Plaque oblique
 L-Placca obliqua



rechts
 right
 derecha
 droit
 destra

709.07.01

②

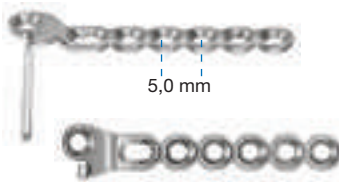

Kondylenplatte
 Condylar plate
 Placa condilar
 Plaque condyilaire
 Placca condilica



Stift links
 Pin left
 Pin izquierda
 Pointe gauche
 Perno sinistra

709.08.00

⑥

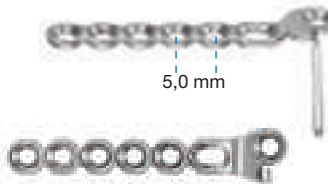

Kondylenplatte
 Condylar plate
 Placa condilar
 Plaque condyilaire
 Placca condilica



Stift rechts
 Pin right
 Pin derecha
 Pointe droit
 Perno destra

709.08.01

⑥



 Plattendicke
 Thickness of plates
 Grosor de las placas
 Epaisseur des plaques
 Spessore delle placche

 Plattenbreite
 Width of plates
 Ancho de la placa
 Largeur des plaques
 Larghezza delle placche

 Anzahl der Löcher
 Number of holes
 Número de los orificios
 Nombre de trous
 Numero di fori

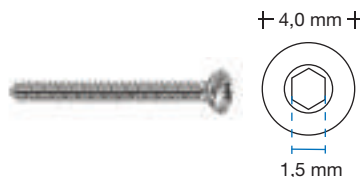
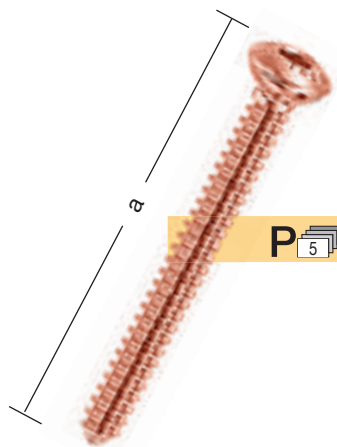

Minifragmentschrauben
Mini Fragment Screws
Tornillos para mini fragmentos
Vis pour mini fragments
Viti per mini frammenti

2.0

Kortikalisschrauben **2,0 mm**
 Cortical screws **2,0 mm**
 Tornillos corticales **2,0 mm**
 Vis corticales **2,0 mm**
 Viti corticalis **2,0 mm**

P 5

a

709.20.01	6
709.20.02	8
709.20.03	10
709.20.04	12
709.20.05	14
709.20.06	16
709.20.07	18
709.20.08	20
709.20.09	22
709.20.10	24
709.20.11	26
709.20.12	28
709.20.13	30
709.20.14	32
709.20.15	34
709.20.16	36
709.20.17	38



2,0 mm



1,3 mm

Bohrer für Gewindeloch 1,5 mm siehe Seite 27
 Drills for threaded hole 1,5 mm see page 27
 Brocas para orificio roscado 1,5 mm vea la página 27
 Forets pour trou fileté de 1,5 mm voir page 27
 Perforatori per foro filettato 1,5 mm vedi pagina 27

Gewindeschneider 2,0 mm siehe Seite 27
 Taps 2,0 mm see page 27
 Roscadores 2,0 mm veáse página 27
 Tarauds 2,0 mm voir page 27
 Filettatori 2,0 mm vedete pagina 27

Bohrer für Gleitloch 2,0 mm siehe Seite 27
 Drills for sliding hole 2,0 mm see page 27
 Brocas para orificio de deslizamiento 2,0 mm vea la página 27
 Forets pour trou lisse de 2,0 mm voir page 27
 Perforatori per foro di scorrimento 2,0 mm vedi pagina 27

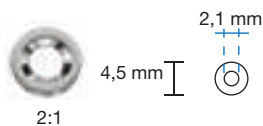

Unterlegscheibe für Kortikalisschrauben 2,0 mm
 Washer for cortical screws 2,0 mm
 Arandela para tornillos corticales 2,0 mm
 Rondelle pour vis corticales 2,0 mm
 Rondella per viti corticalis 2,0 mm

P 5

709.00.00

Verpackungseinheit "X" Stück
 Packing unit "X" pieces
 Paquete de "X" unidades
 Emballage de "X" pièces
 Confezione da "X" pezzi



2.7

**Minifragmentplatten
Mini Fragment Plates
Placas para mini fragmentos
Plaques pour mini fragments
Placche per mini frammenti**

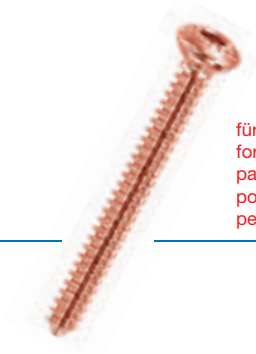

für Kortikalisschrauben **2,7 mm**
for cortical screws **2,7 mm**
para tornillos corticales **2,7 mm**
pour vis corticales **2,7 mm**
per viti corticalis **2,7 mm**

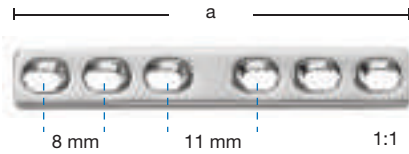

Kompressionsplatten
Compression plates
Placas de compression
Plaques de compression
Placche di compressione

2,0 / 2,5 mm

8,0 mm

a

709.09.02	2,0 mm	20 mm	②
709.09.04	2,0 mm	36 mm	④
709.09.05	2,0 mm	44 mm	⑤
709.09.06	2,0 mm	52 mm	⑥
709.09.07	2,5 mm	60 mm	⑦
709.09.08	2,5 mm	68 mm	⑧
709.09.09	2,5 mm	76 mm	⑨
709.09.10	2,5 mm	84 mm	⑩
709.09.12	2,5 mm	100 mm	⑫

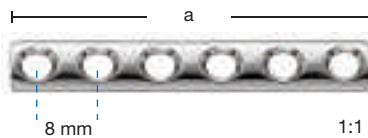
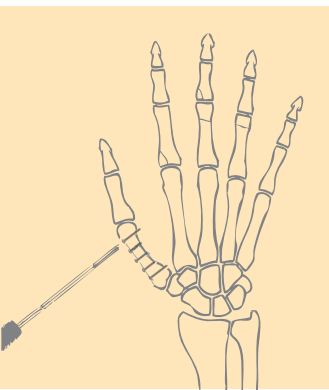

Viertelrohrplatten
Quarter tubular plates
Placas 1/4 tubo
Plaques quart tubulaire
Placche 1/4 tubolare

1,0 mm

7,0 mm

a

709.10.03	23 mm	③
709.10.04	31 mm	④
709.10.05	39 mm	⑤
709.10.06	47 mm	⑥
709.10.07	55 mm	⑦
709.10.08	63 mm	⑧



Plattendicke
Thickness of plates
Grosor de las placas
Epaisseur des plaques
Spessore delle placche



Plattenbreite
Width of plates
Ancho de la placa
Largeur des plaques
Larghezza delle placche



Anzahl der Löcher
Number of holes
Número de los orificios
Nombre de trous
Numero di fori



Minifragmentplatten
Mini Fragment Plates
Placas para mini fragmentos
Plaques pour mini fragments
Placche per mini frammenti

2.7

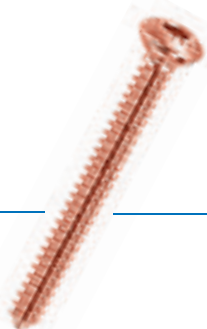

für Kortikalisschrauben **2,7 mm**
 for cortical screws **2,7 mm**
 para tornillos corticales **2,7 mm**
 pour vis corticales **2,7 mm**
 per viti corticalis **2,7 mm**

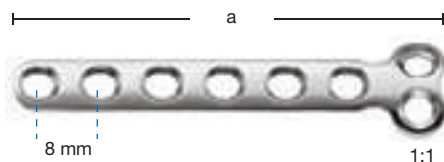

T-Platten
 T-Plates
 T-Placas
 T-Plaques
 T-Placche

		a	
709.11.03	32 mm	③	
709.11.04	40 mm	④	
709.11.05	48 mm	⑤	
709.11.06	56 mm	⑥	
709.11.07	64 mm	⑦	
709.11.08	72 mm	⑧	

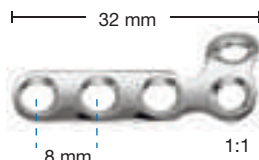

L-Platte 90°
 L-Plate 90°
 L-Placa 90°
 L-Plaque 90°
 L-Placca 90

links left izquierda gauche sinistra	709.12.00	③	

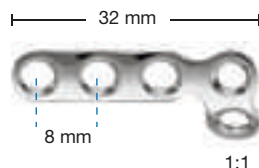

L-Platte 90°
 L-Plate 90°
 L-Placa 90°
 L-Plaque 90°
 L-Placca 90

rechts right derecha droit destra	709.12.01	③	

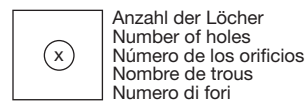



2.7

Minifragmentplatten
Mini Fragment Plates
Placas para mini fragmentos
Plaques pour mini fragments
Placche per mini frammenti

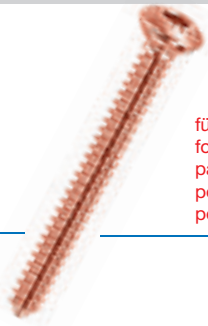

für Kortikalisschrauben **2,7 mm**
 for cortical screws **2,7 mm**
 para tornillos corticales **2,7 mm**
 pour vis corticales **2,7 mm**
 per viti corticalis **2,7 mm**

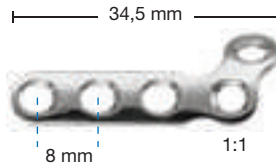

L-Platte schräg
 L-Plate oblique
 L-Placa oblicua
 L-Plaques oblique
 L-Placca obliqua

		<p>links left izquierda gauche sinistra</p> <p>709.13.00</p> <p>③</p>
--	--	--

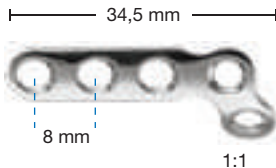

L-Platte schräg
 L-Plate oblique
 L-Placa oblicua
 L-Plaques oblique
 L-Placca obliqua

		<p>rechts right derecha droit destra</p> <p>709.13.01</p> <p>③</p>
--	--	---

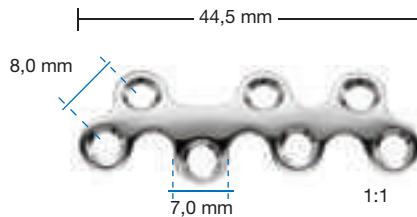

Multifragmentplatte
 Multi fragment plate
 Placa multi fragmentos
 Plaque multifragments
 Placca multi frammenti

		<p>709.14.07</p> <p>⑦</p>
--	--	----------------------------------

	Plattendicke Thickness of plates Grosor de las placas Epaisseur des plaques Spessore delle placche
--	--

	Plattenbreite Width of plates Ancho de la placa Largeur des plaques Larghezza delle placche
--	---

	Anzahl der Löcher Number of holes Número de los orificios Nombre de trous Numero di fori
--	--

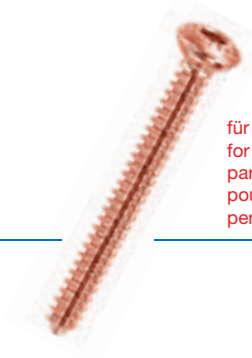

Minifragmentplatten
Mini Fragment Plates
Placas para mini fragmentos
Plaques pour mini fragments
Placche per mini frammenti

2.7

für Kortikalisschrauben **2,7 mm**
 for cortical screws **2,7 mm**
 para tornillos corticales **2,7 mm**
 pour vis corticales **2,7 mm**
 per viti corticalis **2,7 mm**

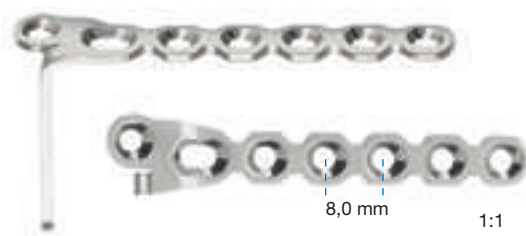

Kondylenplatte
 Condylar plate
 Placa condilar
 Plaque condytaire
 Placca condilica



Stift links
 Pin left
 Pin izquierda
 Pointe gauche
 Perno sinistro

709.14.00

⑥



Kondylenplatte
 Condylar plate
 Placa condilar
 Plaque condytaire
 Placca condilica



Stift rechts
 Pin right
 Pin derecha
 Pointe droit
 Perno destro

709.14.01

⑥

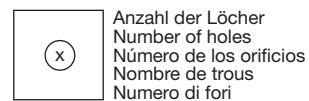



2.7

Minifragmentschrauben
Mini Fragment Screws
Tornillos para mini fragmentos
Vis pour mini fragments
Viti per mini frammenti

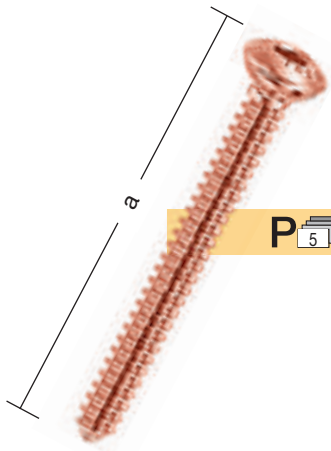

Kortikalisschrauben **2,7 mm**
 Cortical screws **2,7 mm**
 Tornillos corticales **2,7 mm**
 Vis corticales **2,7 mm**
 Viti corticalis **2,7 mm**

P₅

a

709.27.01	6 mm
709.27.02	8 mm
709.27.03	10 mm
709.27.04	12 mm
709.27.05	14 mm
709.27.06	16 mm
709.27.07	18 mm
709.27.08	20 mm
709.27.09	22 mm
709.27.10	24 mm
709.27.11	26 mm
709.27.12	28 mm
709.27.13	30 mm
709.27.14	32 mm
709.27.15	34 mm
709.27.16	36 mm
709.27.17	38 mm
709.27.18	40 mm



Bohrer für Gewindeloch 2,0 mm siehe Seite 27
 Drills for threaded hole 2,0 mm see page 27
 Brocas para orificio roscado 2,0 mm vea la página 27
 Forets pour trou fileté de 2,0 mm voir page 27
 Perforatori per foro filettato 2,0 mm vedi pagina 27

Gewindeschneider 2,7 mm siehe Seite 27
 Tap 2,7 mm see page 27
 Roscador 2,7 mm veáse página 27
 Taraud 2,7 mm voir page 27
 Filettatore 2,7 mm vedi pagina 27

Bohrer für Gleitloch 2,7 mm siehe Seite 27
 Drills for sliding hole 2,7 mm see page 27
 Brocas para orificio de deslizamiento 2,7 mm vea la página 27
 Forets pour trou lisse de 2,7 mm voir page 27
 Perforatori per foro di scorrimento 2,7 mm vedi pagina 27

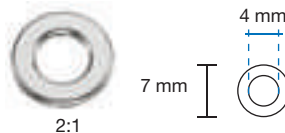

Unterlegscheibe für Kortikalisschrauben 2,7 mm
 Washer for cortical screws 2,7 mm
 Arandela para tornillos corticales 2,7 mm
 Rondelle pour vis corticales 2,7 mm
 Rondella per viti corticalis 2,7 mm

P₅

710.00.00



Verpackungseinheit "X" Stück
 Packing unit "X" pieces
 Paquete de "X" unidades
 Emballage de "X" pièces
 Confezione da "X" pezzi



Minifragment-Instrumentarium
Mini Fragment Instrumentation
Instrumental para mini fragmentos
Instruments pour mini fragments
Strumenti per mini frammenti

1.5

2.0

2.7

Übersicht Schraubendreher, Klingen und Haltehülsen für Schrauben
 Overview screwdrivers, blades and holding sleeves for screws
 Vista general de atornilladores, hojas y vainas para tornillos
 Aperçu tournevis, lames et douilles pour tenir les vis
 Visione generale del cacciavite, lame e boccole per viti

für Schrauben 1,5 und 2,0 mm
for screws 1,5 und 2,0 mm
para tornillos 1,5 und 2,0 mm
pour vis 1,5 und 2,0 mm
per viti 1,5 und 2,0 mm

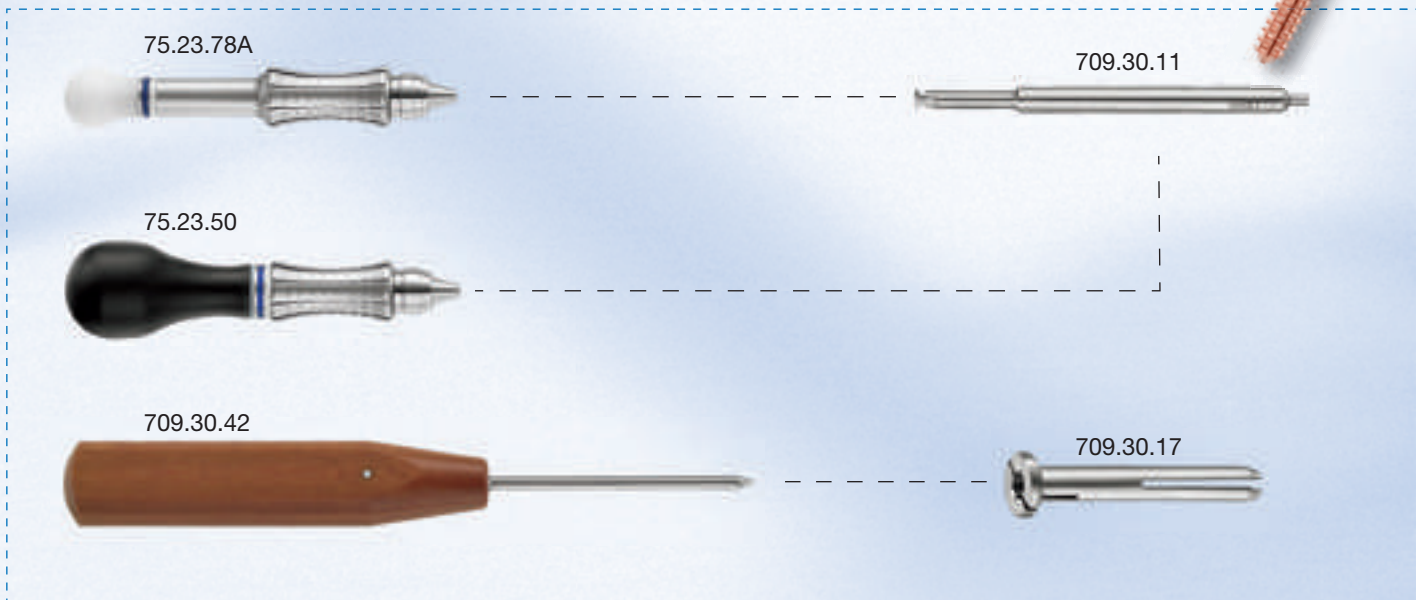
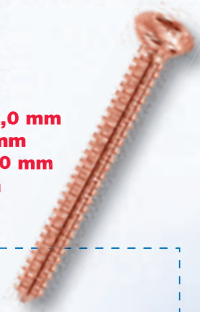

für Schrauben 2,7 mm
for screws 2,7 mm
para tornillos 2,7 mm
pour vis 2,7 mm
per viti 2,7 mm

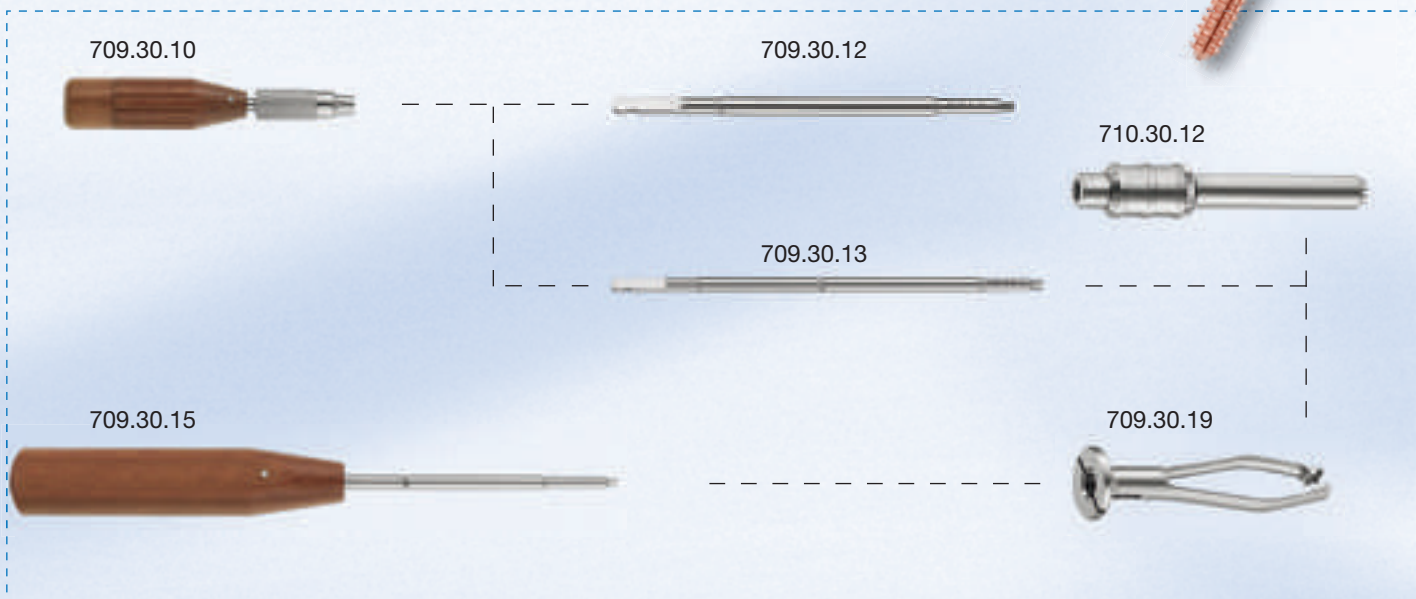
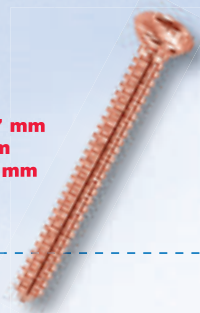

1.5

2.0

2.7

Minifragment-Instrumentarium
Mini Fragment Instrumentation
Instrumental para mini fragmentos
Instruments pour mini fragments
Strumenti per mini frammenti

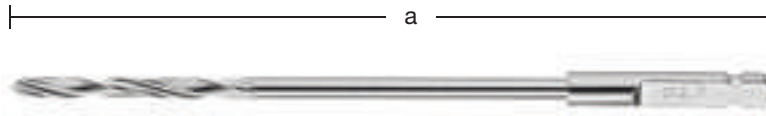

1:1

Bohrer für Schnellkupplung
 Drills for quick coupling
 Brocas para acoplamiento rápido
 Forets pour accouplement rapide
 Perforatori per accoppiamento rapido

	a	Ø
709.30.20	60 mm	1,1 mm
709.30.21	85 mm	1,5 mm
709.30.22	110 mm	1,5 mm
709.30.23	100 mm	2,0 mm
709.30.24	125 mm	2,0 mm
709.30.25	100 mm	2,7 mm
709.30.26	125 mm	2,7 mm

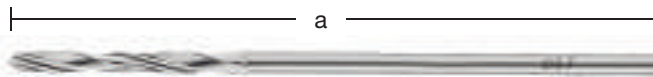

1:1

Bohrer für Dreibackenspannfutter
 Drills for three-jaw chuck
 Brocas para plato de tres mordazas
 Forets pour mandrin à trois mâchoires
 Perforatori per mandrino a tre ganasce

	a	Ø
709.30.27	45 mm	1,1 mm
709.30.28	70 mm	1,5 mm
709.30.29	85 mm	2,7 mm

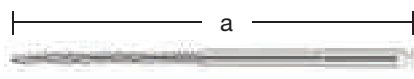

1:1

Gewindeschneider für Dentalkupplung
 Taps for dental coupling
 Roscadores para acoplamiento dental
 Tarauds pour accouplement dentaire
 Filettatori per accoppiamento dentale

	a	Ø
709.30.32	50 mm	1,5 mm
709.30.33	53 mm	2,0 mm

für Kortikalisschrauben
 for cortical screws
 para tornillos corticales
 pour vis corticales
 per viti corticalis

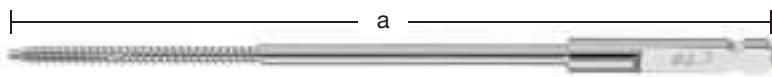

1:1

Gewindeschneider für Schnellkupplung
 Taps for quick coupling
 Roscadores para acoplamiento rápido
 Tarauds pour accouplement rapide
 Filettatori per accoppiamento rapido

	a	Ø
709.30.43	60 mm	1,5 mm
709.30.44	70 mm	2,0 mm
709.30.34	100 mm	2,7 mm

für Kortikalisschrauben
 for cortical screws
 para tornillos corticales
 pour vis corticales
 per viti corticalis

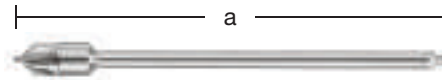

Minifragment-Instrumentarium
Mini Fragment Instrumentation
Instrumental para mini fragmentos
Instruments pour mini fragments
Strumenti per mini frammenti

1.5**2.0****2.7**

1:1

Kopfraumfräser für Dentalkupplung
 Countersink for dental coupling
 Fresa para acoplamiento dental
 Fraise pour accouplement dentaire
 Fresa per accoppiamento dentale

a

für Schrauben Ø 1,5 / 2,0 mm
 for screws Ø 1,5 / 2,0 mm
 para tornillos Ø 1,5 / 2,0 mm
 pour vis Ø 1,5 / 2,0 mm
 per viti Ø 1,5 / 2,0 mm

709.30.30

57 mm

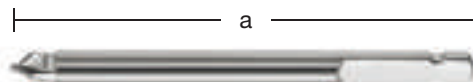

1:1

Kopfraumfräser für Schnellkupplung
 Countersink for quick coupling
 Fresa para acoplamiento rápido
 Fraise pour accouplement rapide
 Fresa per accoppiamento rapido

a

für Schrauben Ø 1,5 / 2,0 mm
 for screws Ø 1,5 / 2,0 mm
 para tornillos Ø 1,5 / 2,0 mm
 pour vis Ø 1,5 / 2,0 mm
 per viti Ø 1,5 / 2,0 mm

709.30.45

60 mm



1:1

Kopfraumfräser für Schnellkupplung
 Countersink for quick coupling
 Fresa para acoplamiento rápido
 Fraise pour accouplement rapide
 Fresa per accoppiamento rapido

a

für Schrauben Ø 2,7 / 3,5 / 4,0 mm
 for screws Ø 2,7 / 3,5 / 4,0 mm
 para tornillos Ø 2,7 / 3,5 / 4,0 mm
 pour vis Ø 2,7 / 3,5 / 4,0 mm
 per viti Ø 2,7 / 3,5 / 4,0 mm

709.30.31

72 mm



1.5

2.0

2.7

Minifragment-Instrumentarium
Mini Fragment Instrumentation
Instrumental para mini fragmentos
Instruments pour mini fragments
Strumenti per mini frammenti



Parallel Bohrbuchse
 Parallel drill sleeve
 Casquillo de taladrar paralelo
 Douille de forage parallèle
 Bussola di foratura parallela



709.30.05

Ø 2,0 mm



Doppelbohrbuchsen
 Double drill sleeves
 Casquillos de taladrar doble
 Double douilles de forage
 Bussole di foratura doppie



709.30.06

Ø 1,5 mm

Ø 1,1 mm

709.30.07

Ø 2,0 mm

Ø 1,5 mm

709.30.08

Ø 2,7 mm

Ø 2,0 mm



Bohrbuchse neutral und exzentrisch
 Drill sleeve neutral and excentric
 Casquillo de taladrar neutral y excéntrico
 Douille de forage neutre et excentrique
 Bussola di foratura neutrale e eccentrica



709.30.09

Ø 2,0 mm

Ø 2,7 mm



für Gewindeschneider
 for taps
 para roscadores
 pour tarauds
 per filettatori



für Bohrer
 for drills
 para brocas
 pour forets
 per perforatori



für Schrauben
 for screws
 para tornillos
 pour vis
 per viti



Minifragment-Instrumentarium
Mini Fragment Instrumentation
Instrumental para mini fragmentos
Instruments pour mini fragments
Strumenti per mini frammenti

1.5

2.0

2.7



Schraubendrehergriff
Screwdriver handle
Mango de atornillador
Manche de tournevis
Manico per cacciavite

mit Dentalkupplung
with dental coupling
con acoplamiento dental
avec accouplement dentaire
con accoppiamento dentale

75.23.78A



Schraubendrehergriff
Screwdriver handle
Mango de atornillador
Manche de tournevis
Manico per cacciavite

mit Dentalkupplung
with dental coupling
con acoplamiento dental
avec accouplement dentaire
con accoppiamento dentale

75.23.50



Handgriff
Handle
Mango
Manche
Manico

mit Schnellkupplung
with quick coupling
con acoplamiento rápido
avec accouplement rapide
con accoppiamento rapido

709.30.10



Kunststoffgriff (autoklavierbar bis 134 °C bei 3 bar)
Plastic handle (autoclavable up to 134 °C at 3 bar)
Mango de plástico (autoclavable hasta 134 °C bajo presión de 3 bar)
Manche en plastique (autoclavable à 134 °C sous pression de 3 bars)
Manico di plastica (autoclavabile fino a 134 °C sotto pressione di 3 bar)

1.5

2.0

2.7

Minifragment-Instrumentarium
Mini Fragment Instrumentation
Instrumental para mini fragmentos
Instruments pour mini fragments
Strumenti per mini frammenti



1:1

Schraubendrehereinsatz Sechskant
 Screwdriver insert hexagonal
 Inserto para atornillador hexagonal
 Insert de tournevis hexagonal
 Inserto per cacciavite esagonale

für Dentalkupplung
 for dental coupling
 para acoplamiento dental
 pour accouplement dentaire
 per accoppiamento dentale

709.30.11

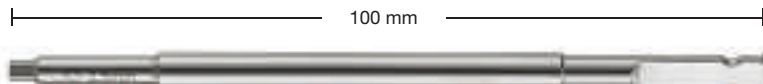

1:1

Schraubendrehereinsatz Sechskant
 Screwdriver insert hexagonal
 Inserto para atornillador hexagonal
 Insert de tournevis hexagonal
 Inserto per cacciavite esagonale

für Schnellkupplung
 for quick coupling
 para acoplamiento rápido
 pour accouplement rapide
 per accoppiamento rapido

709.30.12

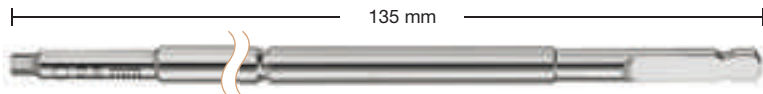

1:1

Schraubendrehereinsatz Sechskant
 Screwdriver insert hexagonal
 Inserto para atornillador hexagonal
 Insert de tournevis hexagonal
 Inserto per cacciavite esagonale

für Schnellkupplung
 for quick coupling
 para acoplamiento rápido
 pour accouplement rapide
 per accoppiamento rapido

709.30.13



Minifragment-Instrumentarium
Mini Fragment Instrumentation
Instrumental para mini fragmentos
Instruments pour mini fragments
Strumenti per mini frammenti

1.5**2.0****2.7**

1,5 mm



Schraubendreher Sechskant
 Screwdriver hexagonal
 Atornillador hexagonal
 Tournevis hexagonal
 Cacciavite esagonale

 **709.30.42** | 18 cm - 7 1/8"

2,5 mm



Schraubendreher Sechskant
 Screwdriver hexagonal
 Atornillador hexagonal
 Tournevis hexagonal
 Cacciavite esagonale

 **709.30.15** | 20 cm - 8"



1:1

Haltehülse für Schrauben
 Holding sleeve for screws
 Vaina para tornillos
 Douille pour tenir les vis
 Boccola per viti

für Schrauben Ø 1,5 / 2,0 mm
 for screws Ø 1,5 / 2,0 mm
 para tornillos Ø 1,5 / 2,0 mm
 pour vis Ø 1,5 / 2,0 mm
 per viti Ø 1,5 / 2,0 mm

709.30.17

Kunststoffgriff (autoklavierbar bis 134 °C bei 3 bar)
 Plastic handle (autoclavable up to 134 °C at 3 bar)
 Mango de plástico (autoclavable hasta 134 °C bajo presión de 3 bar)
 Manche en plastique (autoclavable à 134 °C sous pression de 3 bars)
 Manico di plastica (autoclavabile fino a 134 °C sotto pressione di 3 bar)



1.5

2.0

2.7

Minifragment-Instrumentarium
Mini Fragment Instrumentation
Instrumental para mini fragmentos
Instruments pour mini fragments
Strumenti per mini frammenti



1:1

Haltehülse für Schrauben
 Holding sleeve for screws
 Vaina para tornillos
 Douille pour tenir les vis
 Boccola per viti

für Schrauben Ø 2,7 mm
 for screws Ø 2,7 mm
 para tornillos Ø 2,7 mm
 pour vis Ø 2,7 mm
 per viti Ø 2,7 mm

709.30.19



1:1

Haltehülse für Schrauben
 Holding sleeve for screws
 Vaina para tornillos
 Douille pour tenir les vis
 Boccola per viti

für Schrauben Ø 2,7 mm
 for screws Ø 2,7 mm
 para tornillos Ø 2,7 mm
 pour vis Ø 2,7 mm
 per viti Ø 2,7 mm

710.30.12



Minifragment-Instrumentarium
Mini Fragment Instrumentation
Instrumental para mini fragmentos
Instruments pour mini fragments
Strumenti per mini frammenti

1.5**2.0****2.7**

Bohrlochtiefenlehre
Depth gauge for drill-holes
Instrumento para medir la profundidad
Instrument pour mesurer la profondeur
Strumento per misurare la profondità

für Schrauben Ø 1,5 / 2,0 mm
for screws Ø 1,5 / 2,0 mm
para tornillos Ø 1,5 / 2,0 mm
pour vis Ø 1,5 / 2,0 mm
per viti Ø 1,5 / 2,0 mm

709.30.04

Bohrlochtiefenlehre
Depth gauge for drill-holes
Instrumento para medir la profundidad
Instrument pour mesurer la profondeur
Strumento per misurare la profondità

für Schrauben Ø 2,7 mm
for screws Ø 2,7 mm
para tornillos Ø 2,7 mm
pour vis Ø 2,7 mm
per viti Ø 2,7 mm

710.30.07



1.5

2.0

2.7

Minifragment-Instrumentarium
Mini Fragment Instrumentation
Instrumental para mini fragmentos
Instruments pour mini fragments
Strumenti per mini frammenti



Biegeeisen für Platten 1,5 und 2,0 mm
 Bending lever for plates 1,5 and 2,0 mm
 Palanca para doblar placas 1,5 y 2,0 mm
 Levier de pliage pour plaques 1,5 et 2,0 mm
 Leva piegaplacche per placche 1,5 e 2,0 mm

709.30.00



Biegeeisen für Platten 2,7 mm
 Bending lever for plates 2,7 mm
 Palanca para doblar placas 2,7 mm
 Levier de pliage pour plaques 2,7 mm
 Leva piegaplacche per placche 2,7 mm

709.30.01

rechts
 right
 derecha
 droit
 destra



Biegeeisen für Platten 2,7 mm
 Bending lever for plates 2,7 mm
 Palanca para doblar placas 2,7 mm
 Levier de pliage pour plaques 2,7 mm
 Leva piegaplacche per placche 2,7 mm

709.30.02

links
 left
 izquierda
 gauche
 sinistra



Minifragment-Instrumentarium
Mini Fragment Instrumentation
Instrumental para mini fragmentos
Instruments pour mini fragments
Strumenti per mini frammenti

1.5**2.0****2.7**

Schraubenhaltepinzette
 Screw holding forceps
 Pinza para agarrar tornillos
 Pince pour tenir les vis
 Pinza per tenere viti

709.30.40

Ø 1,25 mm

Ø 0,8 mm



Biegebolzen
 Bending bolt
 Perno para doblar
 Levier de pliage
 Leva per piegare

709.30.41

für Kirschner Bohrdrähte
 for Kirschner wires
 para brocas de Kirschner
 pour broches de Kirschner
 per fili perforatori di Kirschner



Biegezange für Miniplatten
 Bending pliers for Mini plates
 Pinza para doblar placas Mini
 Pince de pliage pour plaques Mini
 Pinza piegaplacche per placche Mini

709.30.03

14 cm - 5½"



1.5

2.0

2.7

Minifragment-Instrumentarium
Mini Fragment Instrumentation
Instrumental para mini fragmentos
Instruments pour mini fragments
Strumenti per mini frammenti

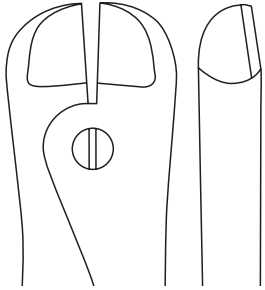

Platten- und Drahtschneidezange
 Plate and wire cutting forceps
 Pinza para cortar placas y alambre
 Pince pour couper les plaques et les fils
 Pinza per tagliare placche e fili

"HM"

Ø 1,6 mm

Ø 2,0 mm

14.30.17

17,5 cm - 7"



Flachzange
 Flat nose pliers
 Alicate plano
 Pince plate
 Tenaglia piatta

14.46.14

14 cm - 5½"

"HM"

Hartmetall
 Tungsten carbide
 Carburo de tungsteno
 Carbure de tungstène
 Carburo di tungsteno

max.

Harte Drähte
 Hard wires
 Alambres duros
 Fils durs
 Fili duri

max.

Weiche Drähte
 Soft wires
 Alambres blandos
 Fils mous
 Fili dolci



Minifragment-Instrumentarium
Mini Fragment Instrumentation
Instrumental para mini fragmentos
Instruments pour mini fragments
Strumenti per mini frammenti

1.5

2.0

2.7

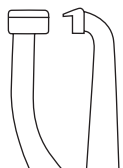

Haltezange für kleine Platten
Holding forceps for small plates
Pinza para agarrar placas pequeñas
Pince pour tenir les petites plaques
Pinza per tenere le placche piccole

709.30.35 | 13,5 cm - 5³/₈"

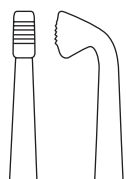

Haltezange für Fingerplatten
Holding forceps for finger plates
Pinza para placas para dedo
Pince de maintien pour plaques de doigts
Pinza per placche per dita

709.30.36 | 13,5 cm - 5³/₈"

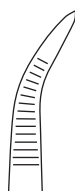

Repositionszange, breit
Reposition forceps, broad
Pinza para reposición, ancha
Pince à réposition, large
Pinza per riposizione, larga

709.30.38 | 13 cm - 5¹/₈"



1.5

2.0

2.7

Minifragment-Instrumentarium
Mini Fragment Instrumentation
Instrumental para mini fragmentos
Instruments pour mini fragments
Strumenti per mini frammenti



Reinigungshaken
 Cleaning hook
 Gancho para limpieza
 Crochet pour nettoyage
 Uncino per pulizia

351.64.01

16 cm - 6 1/4"

3 mm



Raspatorien
 Raspatories
 Legras
 Rugines
 Periostotomi

 **26.64.13**

18,5 cm - 7 1/4"

 **26.64.13P**

18,5 cm - 7 1/4"

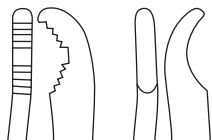

Knochenhaltezange, selbstzentrierend
 Bone holding forceps, self-centering
 Pinza para huesos, autocentrando
 Davier à os, autocentrant
 Tenaglia per ossa, autocentrante

Verbrugge

35.76.15

15 cm - 6"



Kunststoffgriff (autoklavierbar bis 134 °C bei 3 bar)
 Plastic handle (autoclavable up to 134 °C at 3 bar)
 Mango de plástico (autoclavable hasta 134 °C bajo presión de 3 bar)
 Manche en plastique (autoclavable à 134 °C sous pression de 3 bars)
 Manico di plastica (autoclavabile fino a 134 °C sotto pressione di 3 bar)



Minifragment-Instrumentarium
Mini Fragment Instrumentation
Instrumental para mini fragmentos
Instruments pour mini fragments
Strumenti per mini frammenti

1.5

2.0

2.7

6 mm

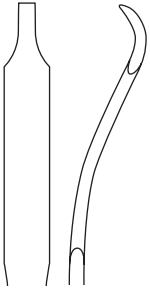

Knochenhebel
Bone lever
Elevador para hueso
Levier à os
Elevatore per ossa

78.35.11 | 16 cm - 6¼"

8 mm

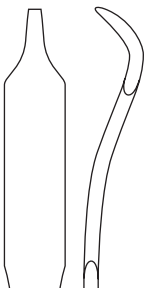

Knochenhebel
Bone lever
Elevador para hueso
Levier à os
Elevatore per ossa

78.35.12 | 16 cm - 6¼"

15 mm

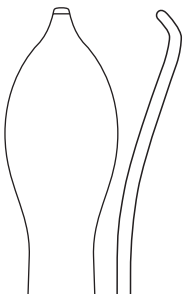

Knochenhebel
Bone lever
Elevador para hueso
Levier à os
Elevatore per ossa

78.35.13 | 16 cm - 6¼"

ORTHO PAEDICS

IMPLANTS AND INSTRUMENTS

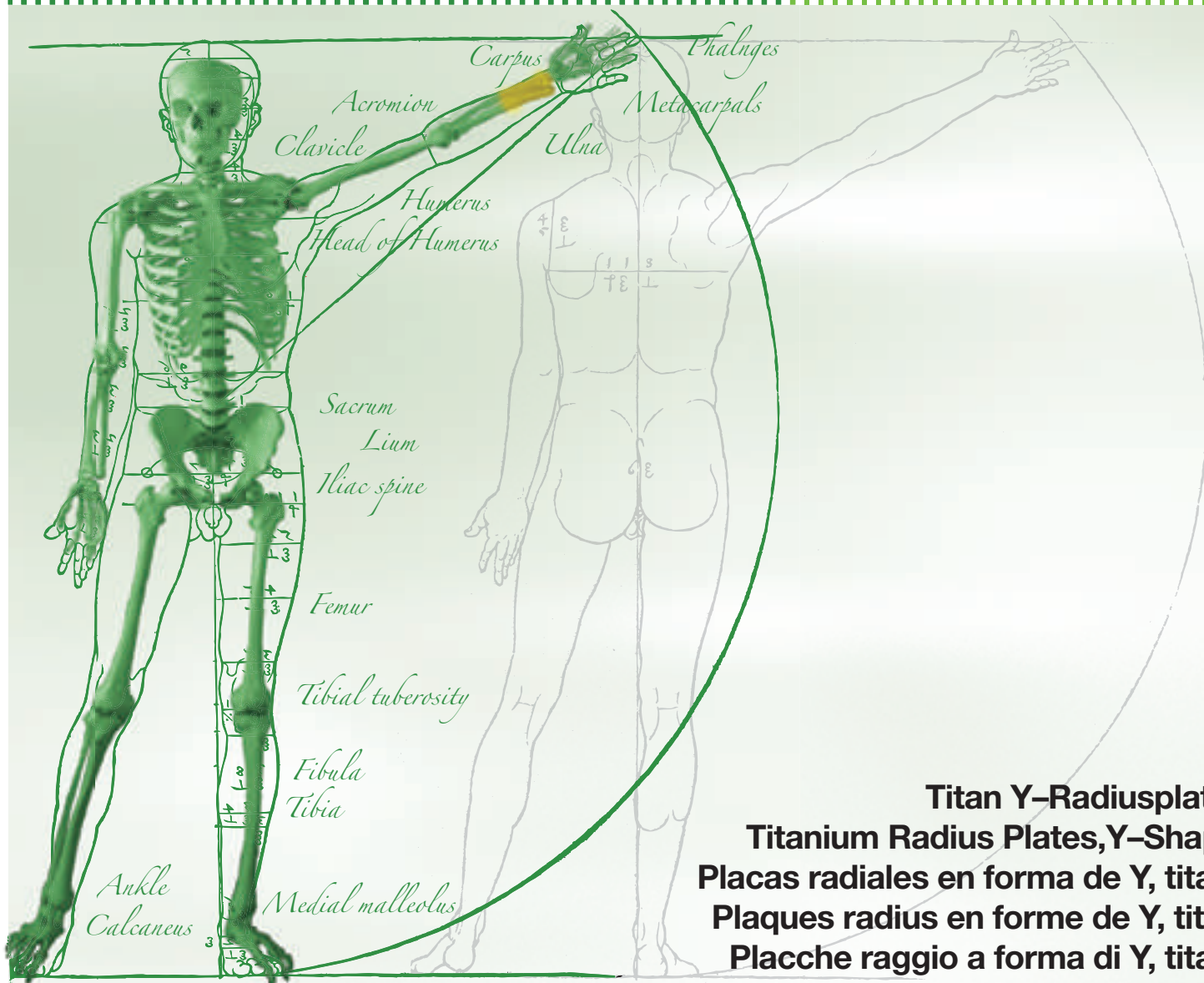

Titan Y-Radiusplatten
Titanium Radius Plates, Y-Shaped
Placas radiales en forma de Y, titanio
Plaques radius en forme de Y, titane
Placche raggio a forma di Y, titanio



Titan Y-Radiusplatten
Titanium Radius Plates Y-Shaped
Placas radiales en forma de Y, titanio
Plaques radius en forme de Y, titane
Placche raggio a forma di Y, titanio





Titan Y-Radiusplatte
 Titanium radius plate Y-shaped
 Placa radial en forma de Y, titanio
 Plaque radius en forme de Y, titane
 Placca raggio a forma di Y, titanio

 1,5 mm	Ti	
rechts right derecha droit destra	78.84.01	(4) × (4)



Titan Y-Radiusplatte
 Titanium radius plate Y-shaped
 Placa radial en forma de Y, titanio
 Plaque radius en forme de Y, titane
 Placca raggio a forma di Y, titanio

 1,5 mm	Ti	
links left izquierda gauche sinistra	78.84.02	(4) × (4)

	Plattendicke Thickness of plates Grosor de las placas Epaisseur des plaques Spessore delle placche
---	--

	Anzahl der Löcher Number of holes Número de los orificios Nombre de trous Numero di fori
---	--

	Titan Titanium Titanio Titane Titanio
---	---



Schrauben für Titan Y-Radiusplatten
Screws for Titanium Radius Plates Y-Shaped
Tornillos para placas radiales en forma de Y, titanio
Vis pour plaques radius en forme de Y, titane
Viti per placche raggio a forma di Y, titanio

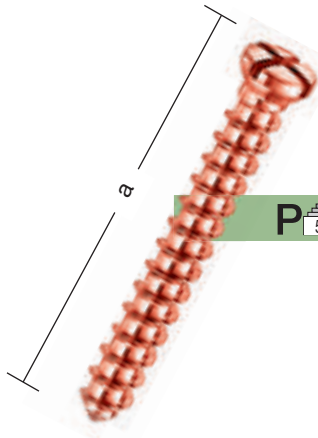

Titan Knochenschrauben Kreuzschlitz
 Titanium bone screws cross slot
 Tornillos de hueso con cabeza en cruz, titanio
 Vis à os cruciformes, titane
 Viti per ossa con presa a croce, titanio

P 5

Ti

a

78.84.13	13 mm
78.84.15	15 mm
78.84.17	17 mm
78.84.19	19 mm
78.84.21	21 mm
78.84.23	23 mm
78.84.25	25 mm
78.84.27	27 mm
78.84.29	29 mm
78.84.31	31 mm
78.84.33	33 mm
78.84.35	35 mm
78.84.37	37 mm

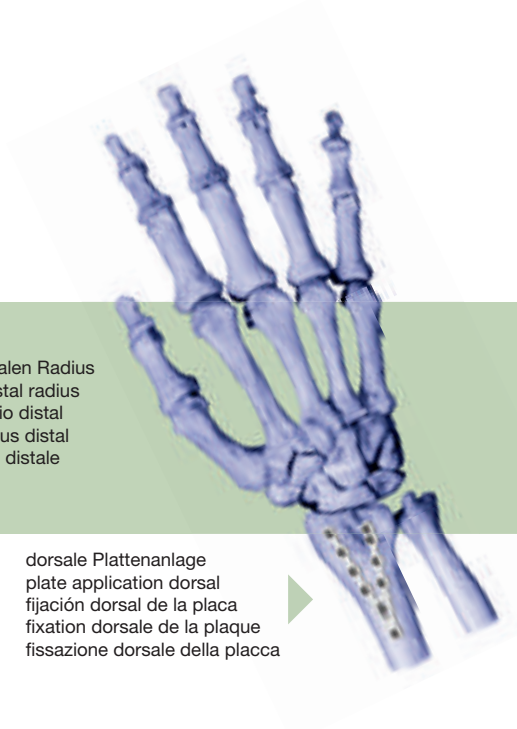

für Frakturen des distalen Radius
 for fractures of the distal radius
 para fracturas del radio distal
 pour fractures du radius distal
 per fratture del raggio distale

dorsale Plattenanlage
 plate application dorsal
 fijación dorsal de la placa
 fixation dorsale de la plaque
 fissazione dorsale della placca



Verpackungseinheit "X" Stück
 Packing unit "X" pieces
 Paquete de "X" unidades
 Emballage de "X" pièces
 Confezione da "X" pezzi



Titan
 Titanium
 Titanio
 Titane
 Titanio



Instrumentarium für Titan Kreuzschlitzschrauben
Instrumentation for Titanium Cross Slot Screws
Instrumental para tornillos de titanio con cabeza cruz
Instruments pour vis en titane cruciformes
Strumenti per viti in titanio con presa a croce



Schraubendrehergriff
 Screwdriver handle
 Mango de atornillador
 Manche de tournevis
 Manico per cacciavite

75.23.55	
-----------------	--

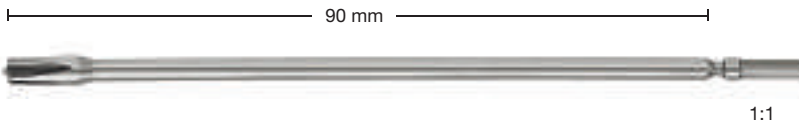

Schraubendreherklinge
 Screwdriver blade
 Hoja de atornillador
 Lame de tournevis
 Lama per cacciavite

78.85.11	
-----------------	--

für Kreuzschlitzschrauben Ø 2,7 mm
 for cross slot screws Ø 2,7 mm
 para tornillo con cabeza en cruz Ø 2,7 mm
 pour vis cruciformes Ø 2,7 mm
 per viti a croce Ø 2,7 mm



Bohrer für Schnellkupplung
 Drill for quick coupling
 Broca para acoplamiento rápido
 Foret pour accouplement rapide
 Perforatore per accoppiamento rapido

709.30.23	Ø
------------------	---

	2,0 mm
--	--------

709.30.23	2,0 mm
------------------	--------

	2,0 mm
--	--------

ORTHO PAEDICS

IMPLANTS AND INSTRUMENTS

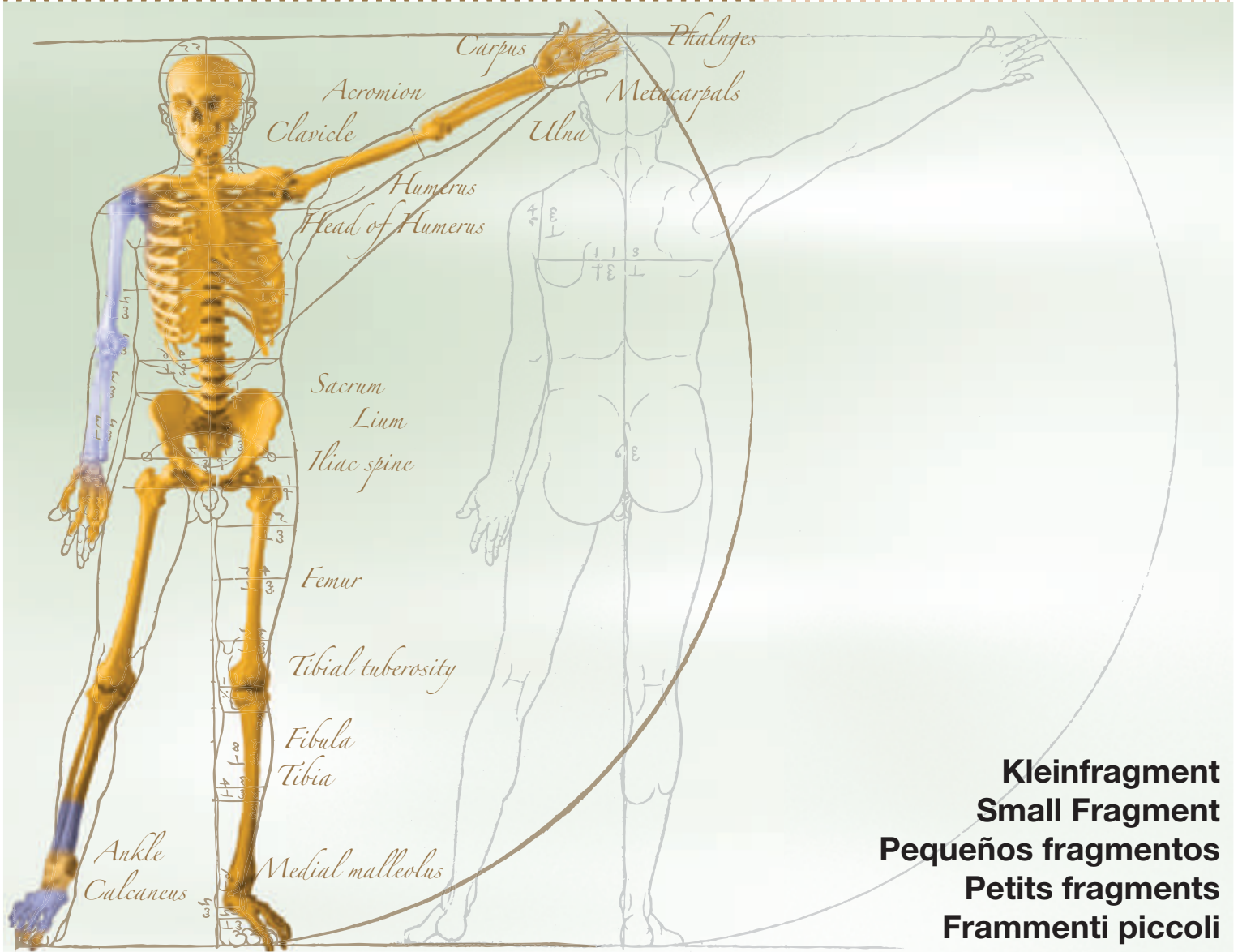

Kleinfragment
Small Fragment
Pequeños fragmentos
Petits fragments
Frammenti piccoli



Kleinfragmentplatten
Small Fragment Plates
Placas para pequeños fragmentos
Plaques pour petits fragments
Placche per frammenti piccoli

3.5**4.0**

für Kortikalisschrauben **3,5 mm** und Spongiosaschrauben **4,0 mm**
 for cortical screws **3,5 mm** and spongiosa screws **4,0 mm**
 para tornillos corticales **3,5 mm** y tornillos esponjosos **4,0 mm**
 pour vis corticales **3,5 mm** et vis spongieuses **4,0 mm**
 per viti corticalis **3,5 mm** e per viti spongiosa **4,0 mm**

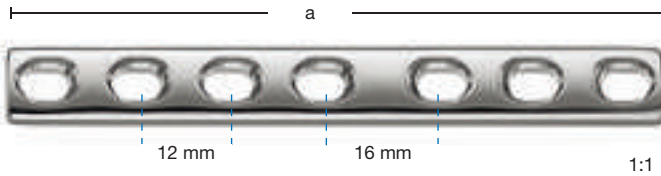

Kompressionsplatten
 Compression plates
 Placas de compresión
 Plaques de compression
 Placche di compressione



	a	
710.00.02	26 mm	②
710.00.03	38 mm	③
710.00.04	50 mm	④
710.00.05	62 mm	⑤
710.00.06	74 mm	⑥
710.00.07	86 mm	⑦
710.00.08	98 mm	⑧
710.00.09	110 mm	⑨
710.00.10	122 mm	⑩
710.00.12	146 mm	⑫
710.00.14	170 mm	⑭
710.00.16	194 mm	⑯
710.00.18	218 mm	⑰

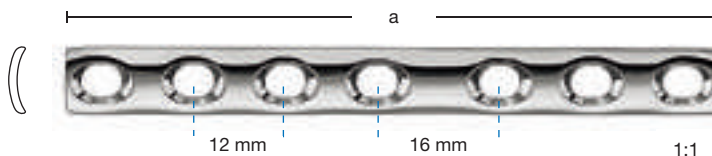

Drittelrohrplatten mit Kragen
 One third plates with collar
 Placas 1/3 tubo con cuello
 Plaques tributaires avec col
 Placche 1/3 tubolare con colletto



	a	
710.01.02	25 mm	②
710.01.03	37 mm	③
710.01.04	49 mm	④
710.01.05	61 mm	⑤
710.01.06	73 mm	⑥
710.01.07	85 mm	⑦
710.01.08	97 mm	⑧
710.01.09	109 mm	⑨
710.01.10	121 mm	⑩
710.01.11	133 mm	⑪
710.01.12	145 mm	⑫

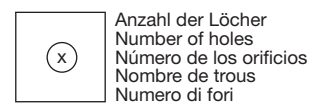
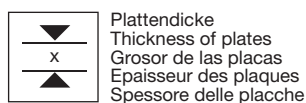



3.5

4.0

Kleinfragmentplatten
Small Fragment Plates
Placas para pequeños fragmentos
Plaques pour petits fragments
Placche per frammenti piccoli

für Kortikalischrauben 3,5 mm und Spongiosaschrauben 4,0 mm
 for cortical screws 3,5 mm and spongiosa screws 4,0 mm
 para tornillos corticales 3,5 mm y tornillos esponjosos 4,0 mm
 pour vis corticales 3,5 mm et vis spongieuses 4,0 mm
 per viti corticalis 3,5 mm e per viti spongiosa 4,0 mm

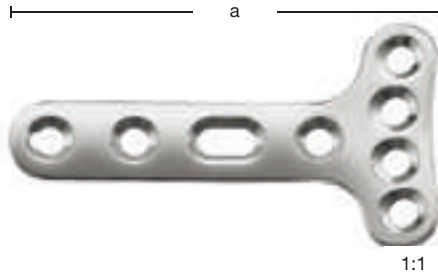
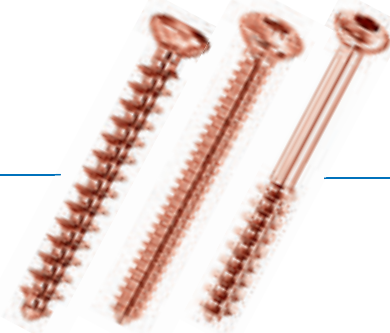

T-Platten 90°
 T-Plates 90°
 T-Placas 90°
 T-Plaques 90°
 T-Placche 90°

		a	
		710.02.03	50 mm ③ × ③
		710.02.04	56 mm ④ × ④
		710.02.05	67 mm ⑤ × ③
		710.02.06	78 mm ⑥ × ④

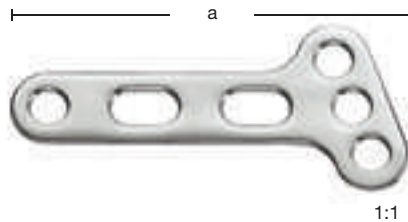

T-Platten schräg
 T-Plates oblique
 T-Placas oblicuas
 T-Plaques obliques
 T-Placche oblique

		a	
		710.03.03	52 mm ③ × ③
		710.03.04	62 mm ④ × ③
		710.03.05	73 mm ⑤ × ③

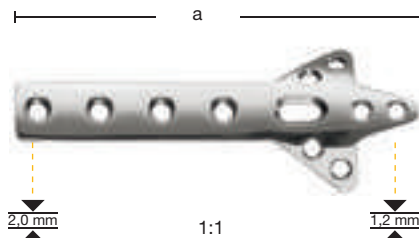

Kleeblattplatten
 Cloverleaf plates
 Placas en forma de trébol
 Plaques trèfles
 Placche a trifoglio

		a	
		710.04.03	88 mm ③
		710.04.04	104 mm ④
		710.04.05	120 mm ⑤
		710.04.06	136 mm ⑥

Plattendicke
 Thickness of plates
 Grosor de las placas
 Epaisseur des plaques
 Spessore delle placche

Plattenbreite
 Width of plates
 Ancho de la placa
 Largeur des plaques
 Larghezza delle placche

Anzahl der Löcher
 Number of holes
 Número de los orificios
 Nombre de trous
 Numero di fori

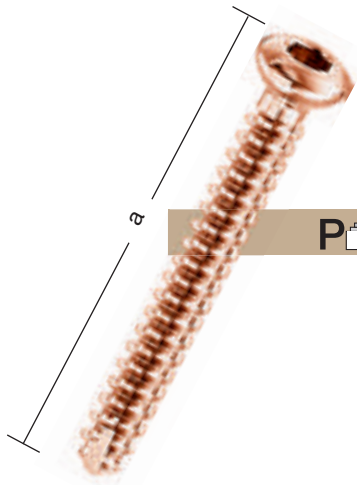

Kleinfragmentschrauben
Small Fragment Screws
Tornillos para pequeños fragmentos
Vis pour petits fragments
Viti per frammenti piccoli

3.5

6,0 mm



1:1

Kortikalisschrauben **3,5 mm**
 Cortical screws **3,5 mm**
 Tornillos corticales **3,5 mm**
 Vis corticales **3,5 mm**
 Viti corticalis **3,5 mm**

P₅

a

		a
710.35.01	710.36.01	10 mm
710.35.02	710.36.02	12 mm
710.35.03	710.36.03	14 mm
710.35.04	710.36.04	16 mm
710.35.05	710.36.05	18 mm
710.35.06	710.36.06	20 mm
710.35.07	710.36.07	22 mm
710.35.08	710.36.08	24 mm
710.35.09	710.36.09	26 mm
710.35.10	710.36.10	28 mm
710.35.11	710.36.11	30 mm
710.35.12	710.36.12	32 mm
710.35.13	710.36.13	34 mm
710.35.14	710.36.14	36 mm
710.35.15	710.36.15	38 mm
710.35.16	710.36.16	40 mm
710.35.17	710.36.17	45 mm
710.35.18	710.36.18	50 mm
710.35.19	710.36.19	55 mm
710.35.20	710.36.20	60 mm
710.35.21	710.36.21	65 mm
710.35.22	710.36.22	70 mm
710.35.23	710.36.23	75 mm
710.35.24	710.36.24	80 mm
710.35.25	710.36.25	85 mm
710.35.26	710.36.26	90 mm
710.35.27	710.36.27	95 mm
710.35.28	710.36.28	100 mm
710.35.29	710.36.29	105 mm
710.35.30	710.36.30	110 mm
710.35.31	710.36.31	115 mm
710.35.32	710.36.32	120 mm



3,5 mm



2,4 mm

Gewindesteigung 1,25 mm
 Thread pitch 1,25 mm
 Paso de rosca 1,25 mm
 Distance entre filetage de 1,25 mm
 Passo del filetto 1,25 mm

Bohrer für Gewindeloch 2,5 mm siehe Seite 51
 Drills for threaded hole 2,5 mm see page 51
 Brocas para orificio roscado 2,5 mm vea la página 51
 Forets pour trou fileté de 2,5 mm voir page 51
 Perforatori per foro filettato 2,5 mm vedi pagina 51

Bohrer für Gleitloch 3,5 mm siehe Seite 51
 Drills for sliding hole 3,5 mm see page 51
 Brocas para orificio de deslizamiento 3,5 mm vea la página 51
 Forets pour trou lisse de 3,5 mm voir page 51
 Perforatori per foro di scorrimento 3,5 mm vedi pagina 51

Gewindeschneider 3,5 mm siehe Seite 51
 Taps 3,5 mm see page 51
 Roscadores 3,5 mm veáse página 51
 Tarauts 3,5 mm voir page 51
 Filettatori 3,5 mm vedi pagina 51



Verpackungseinheit "X" Stück
 Packing unit "X" pieces
 Paquete de "X" unidades
 Emballage de "X" pièces
 Confezione da "X" pezzi



selbstschneidend
 self-tapping
 rosca cortante
 autotaraudeuse
 autofilettanti



Standard
 Standard
 Estandar
 Standard
 Standard

4.0

Kleinfragmentschrauben
Small Fragment Screws
Tornillos para pequeños fragmentos
Vis pour petits fragments
Viti per frammenti piccoli

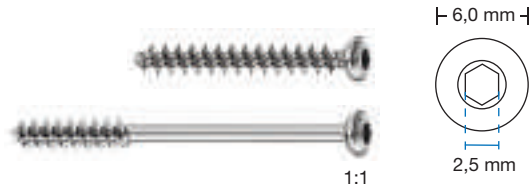

Spongiaschrauben 4,0 mm
 Spongiosa screws 4,0 mm
 Tornillos esponjosos 4,0 mm
 Vis spongieuse 4,0 mm
 Viti spongiosa 4,0 mm

P ₅	a		a		b
	710.40.01	710.40.02	710.41.01	710.41.02	
	10 mm	12 mm	10 mm	12 mm	5 mm
	14 mm	16 mm	14 mm	16 mm	5 mm
	18 mm	20 mm	18 mm	20 mm	6 mm
	22 mm	24 mm	22 mm	24 mm	7 mm
	26 mm	28 mm	26 mm	28 mm	8 mm
	30 mm	32 mm	30 mm	32 mm	9 mm
	34 mm	36 mm	34 mm	36 mm	10 mm
	38 mm	40 mm	38 mm	40 mm	12 mm
	42 mm	44 mm	42 mm	44 mm	14 mm
	46 mm	48 mm	46 mm	48 mm	14 mm
	50 mm	55 mm	50 mm	55 mm	14 mm
	60 mm		60 mm		16 mm

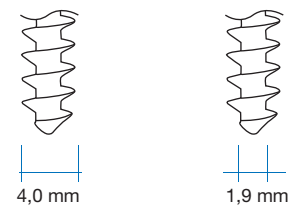

Gewindesteigung 1,75 mm
 Thread pitch 1,75 mm
 Paso de rosca 1,75 mm
 Distance entre filetage de 1,75 mm
 Passo del filetto 1,75 mm

Bohrer für Gewindeloch 2,5 mm siehe Seite 51
 Drills for threaded hole 2,5 mm see page 51
 Brocas para orificio roscado 2,5 mm vea la página 51
 Forets pour trou fileté de 2,5 mm voir page 51
 Perforatori per foro filettato 2,5 mm vedi pagina 51

Gewindeschneider 4,0 mm siehe Seite 52
 Tap 4,0 mm see page 52
 Roscador 4,0 mm veáase página 52
 Taraud 4,0 mm voir page 52
 Filettatore 4,0 mm vedi pagina 52

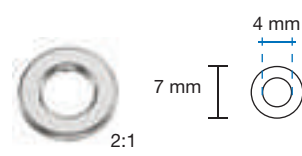

Unterlegscheibe für Spongiaschrauben 4,0 mm
 Washer for spongiosa screws 4,0 mm
 Arandela para tornillos esponjosos 4,0 mm
 Rondelle pour vis spongieuse 4,0 mm
 Rondella per viti spongiosa 4,0 mm

P ₅	710.00.00
----------------	-----------

Verpackungseinheit "X" Stück
 Packing unit "X" pieces
 Paquete de "X" unidades
 Emballage de "X" pièces
 Confezione da "X" pezzi

Vollgewinde
 Full thread
 Rosca completa
 Filetage complet
 Filetto totale

Teilgewinde
 Partial thread
 Rosca parcial
 Filetage partiel
 Filetto parziale



Kleinfragment-Instrumentarium
Small Fragment Instrumentation
Instrumental para pequeños fragmentos
Instruments pour petits fragments
Strumenti per frammenti piccoli

3.5**4.0**

Übersicht Schraubendreher, Klingen und Haltehülsen für Schrauben
Overview screwdrivers, blades and holding sleeves for screws
Vista general de atornilladores, hojas y vainas para tornillos
Aperçu tournevis, lames et douilles pour tenir les vis
Visione generale del cacciavite, lame e boccole per viti

für Kortikalisschrauben 3,5 mm und Spongiaschrauben 4,0 mm
for cortical screws 3,5 mm and spongiosa screws 4,0 mm
para tornillos corticales 3,5 mm y tornillos esponjosos 4,0 mm
pour vis corticales 3,5 mm et vis spongieuses 4,0 mm
per viti corticalis 3,5 mm e viti spongiosa 4,0 mm

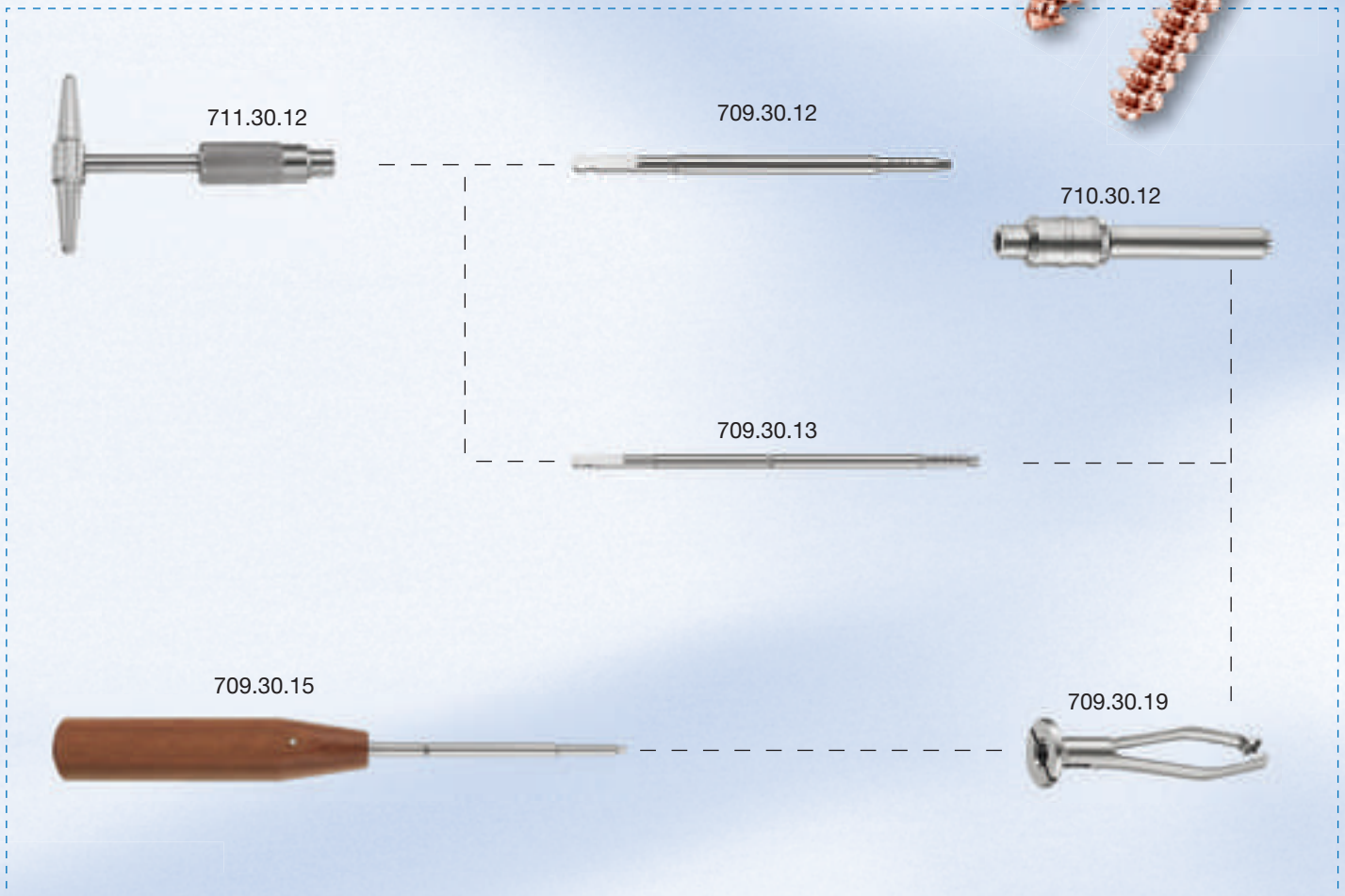



3.5

4.0

Kleinfragment-Instrumentarium
Small Fragment Instrumentation
Instrumental para pequeños fragmentos
Instruments pour petits fragments
Strumenti per frammenti piccoli

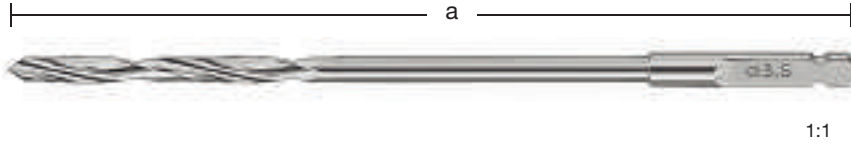

Bohrer für Schnellkupplung
 Drills for quick coupling
 Brocas para acoplamiento rápido
 Forets pour accouplement rapide
 Perforatori per accoppiamento rapido

	a	Ø
710.30.13	110 mm	2,5 mm
710.30.14	180 mm	2,5 mm
710.30.15	110 mm	3,5 mm
710.30.16	145 mm	3,5 mm
710.30.17	195 mm	3,5 mm

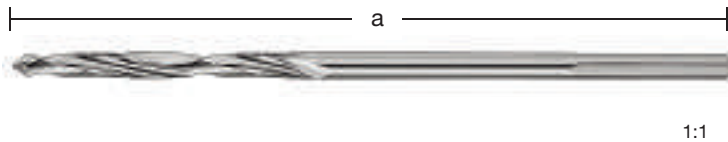

Bohrer für Dreibackenspannfutter
 Drills for three-jaw chuck
 Brocas para plato de tres mordazas
 Forets pour mandrin à trois mâchoires
 Perforatori per mandrino a tre ganasce

	a	Ø
710.30.18	95 mm	2,5 mm
710.30.19	95 mm	3,5 mm
710.30.20	180 mm	3,5 mm

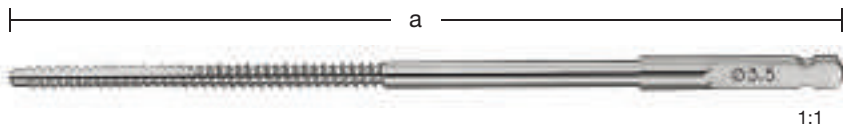

Gewindeschneider für Schnellkupplung
 Tap for quick coupling
 Roscador para acoplamiento rápido
 Taraud pour accouplement rapide
 Filettatore per accoppiamento rapido

	a	Ø
710.30.21	110 mm	3,5 mm

für Kortikalisschrauben
 for cortical screws
 para tornillos corticales
 pour vis corticales
 per viti corticalis

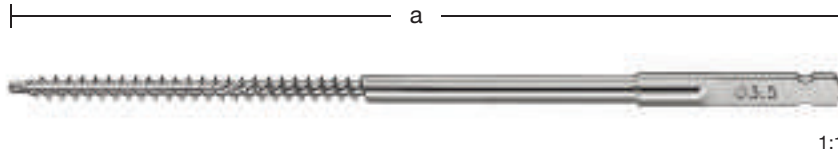

Kleinfragment-Instrumentarium
Small Fragment Instrumentation
Instrumental para pequeños fragmentos
Instruments pour petits fragments
Strumenti per frammenti piccoli

3.5**4.0**

Gewindeschneider für Schnellkupplung
 Taps for quick coupling
 Roscadores para acoplamiento rápido
 Tarauds pour accouplement rapide
 Filettatori per accoppiamento rapido

		a	Ø
für Spongiaschrauben for spongiosa screws	710.30.22	110 mm	3,5 mm
para tornillos esponjosos pour vis spongieuses per viti spongiosa	710.30.23	110 mm	4,0 mm

kalibriert
 calibrated
 calibrado
 calibré
 calibrato



Gewindeschneider für Schnellkupplung
 Tap for quick coupling
 Roscador para acoplamiento rápido
 Taraud pour accouplement rapide
 Filettatore per accoppiamento rapido

		a	Ø
für Kortikalisschrauben for cortical screws para tornillos corticales pour vis corticales per viti corticalis	710.30.24	175 mm	3,5 mm

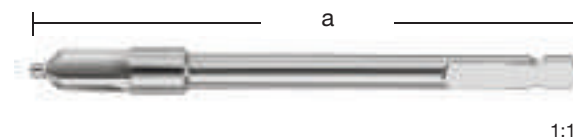

Kopfraumfräser für Schnellkupplung
 Countersink for quick coupling
 Fresa para acoplamiento rápido
 Fraise pour accouplement rapide
 Fresa per accoppiamento rapido

		a
für Schrauben Ø 3,5 / 4,0 mm for screws Ø 3,5 / 4,0 mm para tornillos Ø 3,5 / 4,0 mm pour vis Ø 3,5 / 4,0 mm per viti Ø 3,5 / 4,0 mm	709.30.31	72 mm

3.5

4.0

Kleinfragment-Instrumentarium
Small Fragment Instrumentation
Instrumental para pequeños fragmentos
Instruments pour petits fragments
Strumenti per frammenti piccoli



Universalbohrbuchse
 Universal drill sleeve
 Casquillo de taladrar universal
 Douille de forage universel
 Centrapunta universale



710.30.10	Ø 3,5 mm	Ø 2,5 mm
------------------	----------	----------



Bohrbuchse neutral und exzentrisch
 Drill sleeve sleeve neutral and excentric
 Casquillo de taladrar neutral y excéntrico
 Douille de forage neutre et excentrique
 Bussola di foratura neutrale e eccentrica

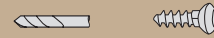

709.30.11	Ø 2,5 mm	Ø 3,5 mm
------------------	----------	----------



Steckbohrbuchse
 Insert drill sleeve
 Casquillo de insercion
 Fixation douille de forage
 Centrapunta retta

710.30.08



Doppelbohrbuchse
 Double drill sleeve
 Casquillo de taladrar doble
 Double douilles de forage
 Bussola di foratura doppia



710.30.09	Ø 3,5 mm	Ø 2,5 mm
------------------	----------	----------



für Gewindeschneider
 for taps
 para roscadores
 pour tarauds
 per filettatori



für Bohrer
 for drills
 para brocas
 pour forets
 per perforator



für Schrauben
 for screws
 para tornillos
 pour vis
 per viti



Kleinfragment-Instrumentarium
Small Fragment Instrumentation
Instrumental para pequeños fragmentos
Instruments pour petits fragments
Strumenti per frammenti piccoli

3.5

4.0



1:1

Parallel Bohrbuchse
Parallel drill sleeve sleeve
Casquillo de taladrar paralelo
Douille de forage parallèle
Bussola di foratura parallela



709.30.05

Ø 2,0 mm



Plattenspanner mit Kraftanzeige
Plate tensioner with gauge
Extensor de placa con indicacion de fuerza
Plaque à tension avec gauge
Tenditore di placche con indicatore di forza

710.30.25



Ring-/Gabelschlüssel 11 mm
Combination wrench 11 mm
Llave bifurcada/anular 11 mm
Clé torse combination 11 mm
Chiave anello/forchetta 11 mm

710.30.26



Kardanschlüssel 11 mm
Cardan wrench 11 mm
Llave cardan 11 mm
Clé torse cardan 11 mm
Chiave cardan 11 mm

711.30.32



für Bohrer
for drills
para brocas
pour forets
per perforator

3.5 **4.0**

Kleinfragment-Instrumentarium
Small Fragment Instrumentation
Instrumental para pequeños fragmentos
Instruments pour petits fragments
Strumenti per frammenti piccoli



T-Griff, klein, mit Schnellkupplung
 T-Handle, small, with quick coupling
 Mango en T, pequeño, con acoplamiento rápido
 Manche en T, petit, avec accouplement rapide
 Manico a T, piccolo, con accoppiamento rapido

711.30.12

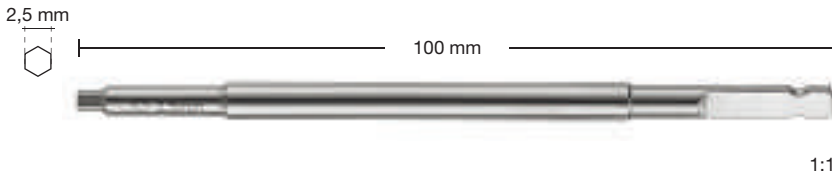

Schraubendrehereinsatz Sechskant
 Screwdriver insert hexagonal
 Inserto para atornillador hexagonal
 Insert de tournevis hexagonal
 Inserto per cacciavite esagonale

1:1

709.30.12

für Schnellkupplung
 for quick coupling
 para acoplamiento rápido
 pour accouplement rapide
 per accoppiamento rapido

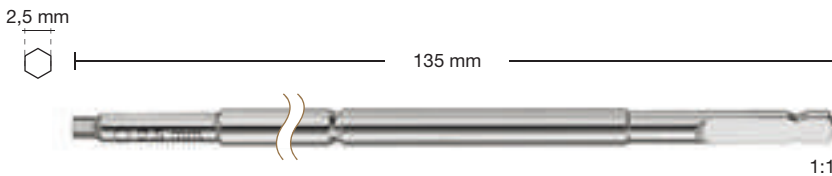

Schraubendrehereinsatz Sechskant
 Screwdriver insert hexagonal
 Inserto para atornillador hexagonal
 Insert de tournevis hexagonal
 Inserto per cacciavite esagonale

1:1

709.30.13

für Schnellkupplung
 for quick coupling
 para acoplamiento rápido
 pour accouplement rapide
 per accoppiamento rapido



Schraubendreher Sechskant
 Screwdriver hexagonal
 Atornillador hexagonal
 Tournevis hexagonal
 Cacciavite esagonale

709.30.15

20 cm - 8"



Kunststoffgriff (autoklavierbar bis 134 °C bei 3 bar)
 Plastic handle (autoclavable up to 134 °C at 3 bar)
 Mango de plástico (autoclavable hasta 134 °C bajo presión de 3 bar)
 Manche en plastique (autoclavable à 134 °C sous pression de 3 bars)
 Manico di plastica (autoclavabile fino a 134 °C sotto pressione di 3 bar)



Kleinfragment-Instrumentarium
Small Fragment Instrumentation
Instrumental para pequeños fragmentos
Instruments pour petits fragments
Strumenti per frammenti piccoli

3.5**4.0**

1:1

Haltehülse für Schrauben
 Holding sleeve for screws
 Vaina para tornillos
 Douille pour tenir les vis
 Boccola per viti

für Schrauben Ø 3,5 / 4,0 mm
 for screws Ø 3,5 / 4,0 mm
 para tornillos Ø 3,5 / 4,0 mm
 pour vis Ø 3,5 / 4,0 mm
 per viti Ø 3,5 / 4,0 mm

710.30.12

1:1

Haltehülse für Schrauben
 Holding sleeve for screws
 Vaina para tornillos
 Douille pour tenir les vis
 Boccola per viti

für Schrauben Ø 3,5 / 4,0 mm
 for screws Ø 3,5 / 4,0 mm
 para tornillos Ø 3,5 / 4,0 mm
 pour vis Ø 3,5 / 4,0 mm
 per viti Ø 3,5 / 4,0 mm

709.30.19

Schraubenhaltepinzette
 Screw holding forceps
 Pinza para agarrar tornillos
 Pince pour tenir les vis
 Pinza per tenere viti

709.30.40

Bohrlochtiefenlehre
 Depth gauge for drill-holes
 Instrumento para medir la profundidad
 Instrument pour mesurer la profondeur
 Strumento per misurare la profondità

für Schrauben Ø 3,5 / 4,0 mm
 for screws Ø 3,5 / 4,0 mm
 para tornillos Ø 3,5 / 4,0 mm
 pour vis Ø 3,5 / 4,0 mm
 per viti Ø 3,5 / 4,0 mm

710.30.07



3.5

4.0

Kleinfragment-Instrumentarium
Small Fragment Instrumentation
Instrumental para pequeños fragmentos
Instruments pour petits fragments
Strumenti per frammenti piccoli



Biegeeisen für Platten 3,5 mm
 Bending lever for plates 3,5 mm
 Palanca para doblar placas 3,5 mm
 Levier de pliage pour plaques 3,5 mm
 Leva piegaplacche per placche 3,5 mm

rechts
 right
 derecha
 droit
 destra

709.30.01



Biegeeisen für Platten 3,5 mm
 Bending lever for plates 3,5 mm
 Palanca para doblar placas 3,5 mm
 Levier de pliage pour plaques 3,5 mm
 Leva piegaplacche per placche 3,5 mm

links
 left
 izquierda
 gauche
 sinistra

709.30.02



Biegebolzen für Kirschner Drähte bis 2,7 mm
 Bending bolt for Kirschner wires up to 2,7 mm
 Perno para doblar brocas de Kirschner 2,7 mm
 Levier de pliage pour broches de Kirschner 2,7 mm
 Leva per piegare fili di Kirschner 2,7 mm

710.30.00



Biegeschablonen für Platten 3,5 mm
 Bending templates for plates 3,5 mm
 Placas de premoldeación para placas 3,5 mm
 Plaques de préformation pour plaques 3,5 mm
 Placche sagomabili per placche 3,5 mm

710.30.01

⑤

710.30.02

⑦

710.30.03

⑨

710.30.04

⑫



Anzahl der Löcher
 Number of holes
 Número de los orificios
 Nombre de trous
 Numero di fori



Kleinfragment-Instrumentarium
Small Fragment Instrumentation
Instrumental para pequeños fragmentos
Instruments pour petits fragments
Strumenti per frammenti piccoli

3.5

4.0

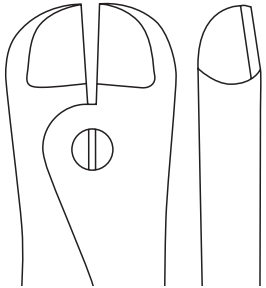

Platten- und Drahtschneidezange
 Plate and wire cutting forceps
 Pinza para cortar placas y alambre
 Pince pour couper les plaques et les fils
 Pinza per tagliare placche e fili

"HM"	Ø 1,6 mm	14.30.17	17,5 cm - 7"
	Ø 2,0 mm		

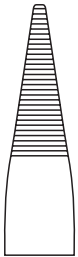

Flachzange
 Flat nose pliers
 Alicata plano
 Pince plate
 Tenaglia piatta

		76.45.19	19 cm - 7½"
--	--	-----------------	-------------



Reinigungshaken
 Cleaning hook
 Gancho para limpieza
 Crochet pour nettoyage
 Uncino per pulizia

		351.64.01	16 cm - 6¼"
--	--	------------------	-------------

"HM"
 Hartmetall
 Tungsten carbide
 Carburo de tungsteno
 Carbure de tungstène
 Carburo di tungsteno

max.
 Harte Drähte
 Hard wires
 Alambres duros
 Fils durs
 Fili duri

max.
 Weiche Drähte
 Soft wires
 Alambres blandos
 Fils mous
 Fili dolci

3.5

4.0

Kleinfragment-Instrumentarium
Small Fragment Instrumentation
Instrumental para pequeños fragmentos
Instruments pour petits fragments
Strumenti per frammenti piccoli



Knochenhaltezange
 Bone holding forceps
 Pinza para huesos
 Davier à os
 Tenaglia per ossa

35.11.13 13,5 cm - 5³/₈"

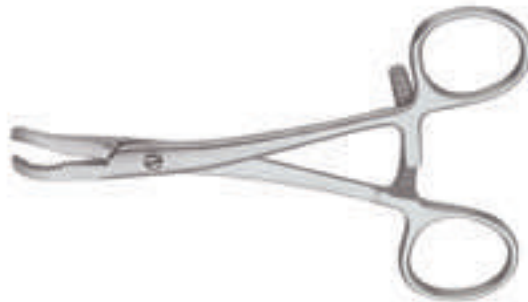
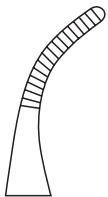

Knochenhaltezange
 Bone holding forceps
 Pinza para huesos
 Davier à os
 Tenaglia per ossa

35.14.14 14 cm - 5¹/₂"

6 mm

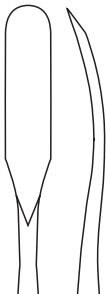

Raspatorien
 Raspatories
 Legras
 Rugines
 Periostotomi

 **26.64.26** 18,5 cm - 7¹/₄"

 **26.64.26P** 18,5 cm - 7¹/₄"



Kunststoffgriff (autoklavierbar bis 134 °C bei 3 bar)
 Plastic handle (autoclavable up to 134 °C at 3 bar)
 Mango de plástico (autoclavable hasta 134 °C bajo presión de 3 bar)
 Manche en plastique (autoclavable à 134 °C sous pression de 3 bars)
 Manico di plastica (autoclavabile fino a 134 °C sotto pressione di 3 bar)



Kleinfragment-Instrumentarium
Small Fragment Instrumentation
Instrumental para pequeños fragmentos
Instruments pour petits fragments
Strumenti per frammenti piccoli

3.5

4.0

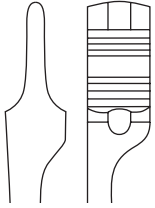

Knochenhaltezange, selbstzentrierend
Bone holding forceps, self-centering
Pinza para huesos, autocentrando
Davier à os, autocentrant
Tenaglia per ossa, autocentrante

Verbrugge

35.76.19

19 cm - 7½"

6 mm

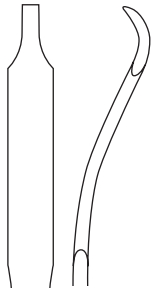

Knochenhebel
Bone lever
Elevador para hueso
Levier à os
Elevatore per ossa

78.35.11

16 cm - 6¼"

8 mm

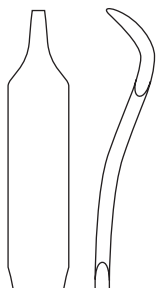

Knochenhebel
Bone lever
Elevador para hueso
Levier à os
Elevatore per ossa

78.35.12

16 cm - 6¼"

ORTHO PAEDICS

IMPLANTS AND INSTRUMENTS

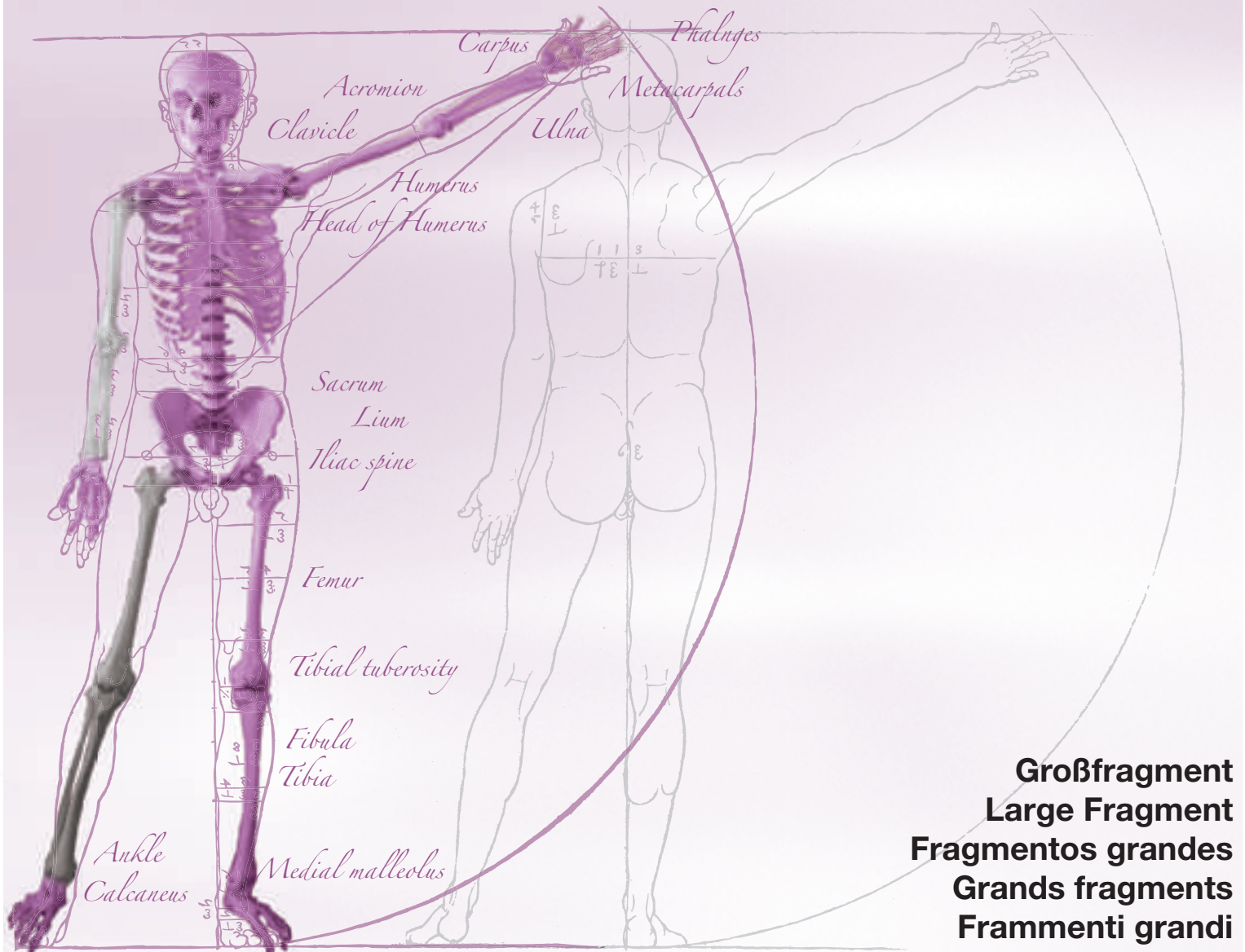

Großfragment
Large Fragment
Fragmentos grandes
Grands fragments
Frammenti grandi



Großfragmentplatten
Large Fragment Plates
Placas para fragmentos grandes
Plaques pour grands fragments
Placche per frammenti grandi

4.5

6.5

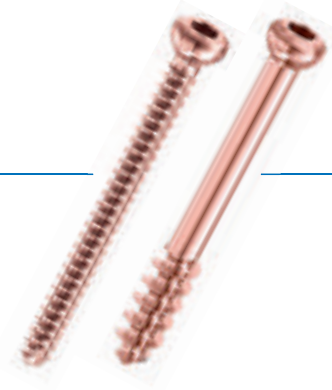

für Kortikalisschrauben **4,5 mm** und Spongiosaschrauben **6,5 mm**
 for cortical screws **4,5 mm** and spongiosa screws **6,5 mm**
 para tornillos corticales **4,5 mm** y tornillos esponjosos **6,5 mm**
 pour vis corticales **4,5 mm** et vis spongieuses **6,5 mm**
 per viti corticalis **4,5 mm** e viti spongiosa **6,5 mm**

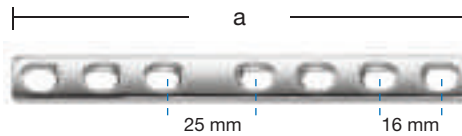

Schmale Kompressionsplatten
 Compression plates narrow
 Placas de compresión estrechas
 Plaques de compression étroites
 Placche di compressione strette

$\frac{4,0 \text{ mm}}{\text{▲▼}}$	$\text{▶} 12 \text{ mm} \text{◀}$	a	
		39 mm	②
		55 mm	③
		71 mm	④
		87 mm	⑤
		103 mm	⑥
		119 mm	⑦
		135 mm	⑧
		151 mm	⑨
		167 mm	⑩
		183 mm	⑪
		199 mm	⑫
		215 mm	⑬
		231 mm	⑭
		247 mm	⑮
		263 mm	⑯
		295 mm	⑰

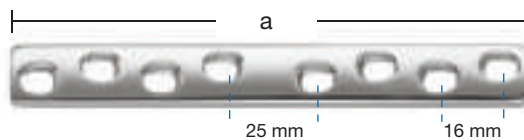

Breite Kompressionsplatten
 Compression plates wide
 Placas de compresión anchas
 Plaques de compression larges
 Placche di compressione larghe

$\frac{5,0 \text{ mm}}{\text{▲▼}}$	$\text{▶} 16,2 \text{ mm} \text{◀}$	a	
		87 mm	⑤
		103 mm	⑥
		119 mm	⑦
		135 mm	⑧
		151 mm	⑨
		167 mm	⑩
		183 mm	⑪
		199 mm	⑫
		215 mm	⑬
		231 mm	⑭
		247 mm	⑮
		263 mm	⑯
		295 mm	⑰



Plattendicke
 Thickness of plates
 Grosor de las placas
 Epaisseur des plaques
 Spessore delle placche



Plattenbreite
 Width of plates
 Ancho de la placa
 Largeur des plaques
 Larghezza delle placche



Anzahl der Löcher
 Number of holes
 Número de los orificios
 Nombre de trous
 Numero di fori



4.5

6.5

Großfragmentplatten
Large Fragment Plates
Placas para fragmentos grandes
Plaques pour grands fragments
Placche per frammenti grandi

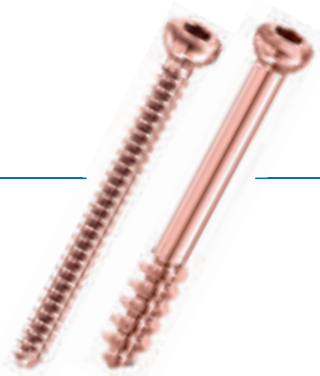

für Kortikalisschrauben **4,5 mm** und Spongiosaschrauben **6,5 mm**
 for cortical screws **4,5 mm** and spongiosa screws **6,5 mm**
 para tornillos corticales **4,5 mm** y tornillos esponjosos **6,5 mm**
 pour vis corticales **4,5 mm** et vis spongieuses **6,5 mm**
 per viti corticalis **4,5 mm** e viti spongiosa **6,5 mm**

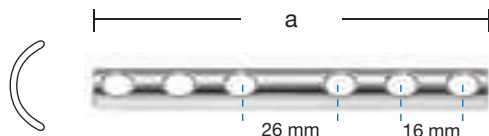

Halbrohrplatten
 Semi tubular plates
 Placas 1/2 tubo
 Plaques semi tubulaires
 Placche semitubolari

1,1 mm	11,6 mm	a	
		39 mm	②
		55 mm	③
		71 mm	④
		87 mm	⑤
		103 mm	⑥
		119 mm	⑦
		135 mm	⑧
		151 mm	⑨
		167 mm	⑩
		183 mm	⑪
		199 mm	⑫

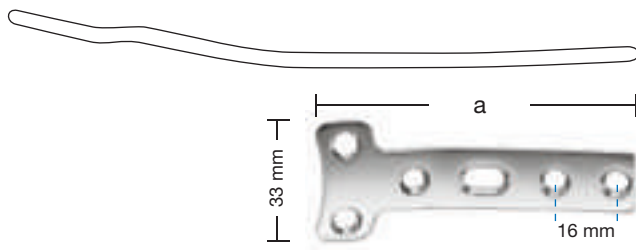

T-Platten groß
 T-Plates large
 T-Placas grandes
 T-Plaques grandes
 T-Placche grandi

2,0 mm	17 mm	a	
		68 mm	③
		84 mm	④
		100 mm	⑤
		116 mm	⑥
		134 mm	⑦
		148 mm	⑧

Plattendicke
 Thickness of plates
 Grosor de las placas
 Epaisseur des plaques
 Spessore delle placche

Plattenbreite
 Width of plates
 Ancho de la placa
 Largeur des plaques
 Larghezza delle placche

Anzahl der Löcher
 Number of holes
 Número de los orificios
 Nombre de trous
 Numero di fori



Großfragmentplatten
Large Fragment Plates
Placas para fragmentos grandes
Plaques pour grands fragments
Placche per frammenti grandi

4.5

6.5

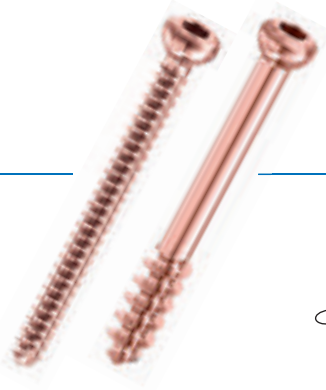

für Kortikalisschrauben **4,5 mm** und Spongiosaschrauben **6,5 mm**
 for cortical screws **4,5 mm** and spongiosa screws **6,5 mm**
 para tornillos corticales **4,5 mm** y tornillos esponjosos **6,5 mm**
 pour vis corticales **4,5 mm** et vis spongieuses **6,5 mm**
 per viti corticalis **4,5 mm** e viti spongiosa **6,5 mm**

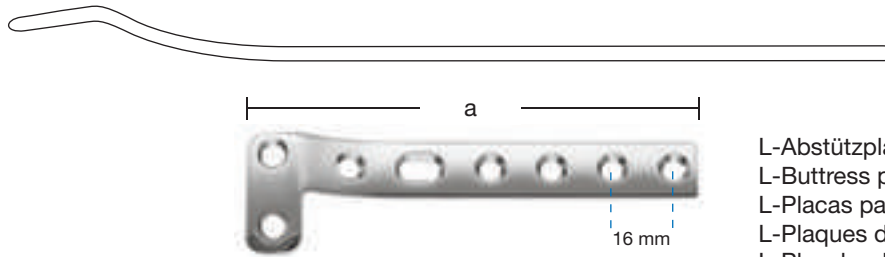

L-Abstützplatten
 L-Buttress plates
 L-Placas para apoyar
 L-Plaques d'appui
 L-Placche di sostegno

	2,0 mm	16 mm	a	
links abgewinkelt (für rechtes Bein) angled left (for right leg) angulada hacia izquierda (para pierna derecha) coudée à gauche (pour jambe droite) angolato sinistra (per gamba destra)				
			87 mm	④
			119 mm	⑥
			151 mm	⑧

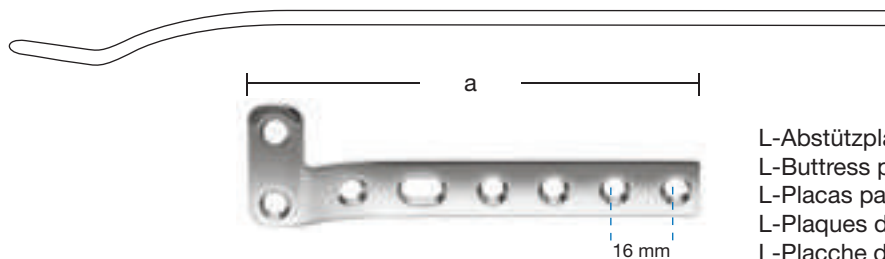

L-Abstützplatten
 L-Buttress plates
 L-Placas para apoyar
 L-Plaques d'appui
 L-Placche di sostegno

	2,0 mm	16 mm	a	
rechts abgewinkelt (für linkes Bein) angled right (for left leg) angulada hacia derecha (para pierna izquierda) coudée à droite (pour jambe gauche) angolato destra (per gamba sinistra)				
			87 mm	④
			119 mm	⑥
			151 mm	⑧

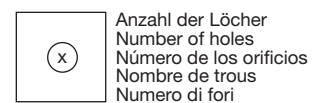
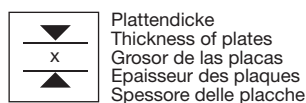



4.5

6.5

Großfragmentplatten
Large Fragment Plates
Placas para fragmentos grandes
Plaques pour grands fragments
Placche per frammenti grandi

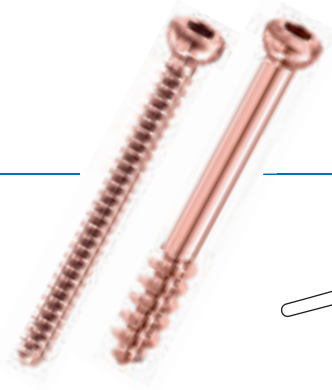

für Kortikalisschrauben **4,5 mm** und Spongiaschrauben **6,5 mm**
 for cortical screws **4,5 mm** and spongiosa screws **6,5 mm**
 para tornillos corticales **4,5 mm** y tornillos esponjosos **6,5 mm**
 pour vis corticales **4,5 mm** et vis spongieuses **6,5 mm**
 per viti corticalis **4,5 mm** e viti spongiosa **6,5 mm**

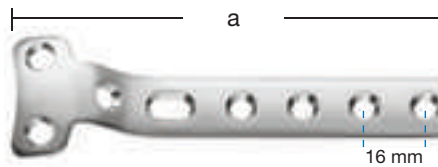

T-Abstützplatten
 T-Buttress plates
 T-Placas para apoyar
 T-Plaques d'appui
 T-Placche di sostegno

		a	
		711.08.04	84 mm (4)
		711.08.05	100 mm (5)
		711.08.06	116 mm (6)
		711.08.08	148 mm (8)

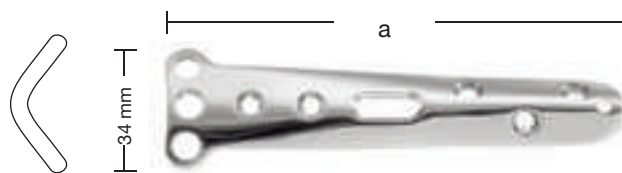

Löffelplatten
 Spoon plates
 Placas en forma de cuchara
 Plaques cuillère
 Placche cucchiaio

		a	
		711.09.05	100 mm (5)
		711.09.06	120 mm (6)

Plattendicke
 Thickness of plates
 Grosor de las placas
 Epaisseur des plaques
 Spessore delle placche

Plattenbreite
 Width of plates
 Ancho de la placa
 Largeur des plaques
 Larghezza delle placche

Anzahl der Löcher
 Number of holes
 Número de los orificios
 Nombre de trous
 Numero di fori



Großfragmentplatten
Large Fragment Plates
Placas para fragmentos grandes
Plaques pour grands fragments
Placche per frammenti grandi

4.5

6.5

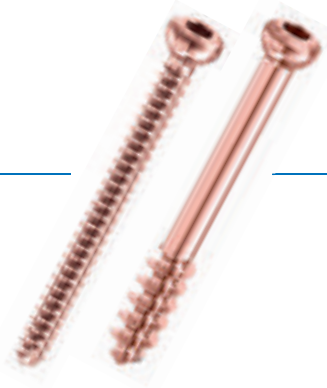

für Kortikalisschrauben **4,5 mm** und Spongiosaschrauben **6,5 mm**
 for cortical screws **4,5 mm** and spongiosa screws **6,5 mm**
 para tornillos corticales **4,5 mm** y tornillos esponjosos **6,5 mm**
 pour vis corticales **4,5 mm** et vis spongieuse **6,5 mm**
 per viti corticalis **4,5 mm** e viti spongiosa **6,5 mm**

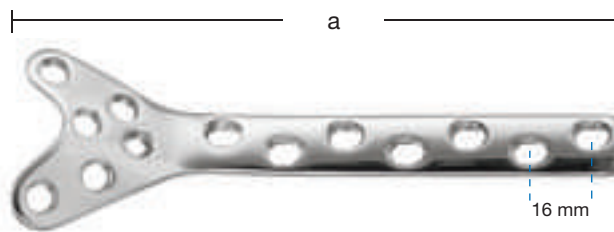

Kondylenabstützplatten, distal
 Condylar buttress plates, distal
 Placas condilares para apoyar, distal
 Plaques d'appui condilaire, distales
 Placche condilari per sostegno, distale



für linkes Bein
 for left leg
 para pierna izquierda
 pour jambe gauche
 per gamba sinistra

	a	
711.10.07	158 mm	⑦
711.10.09	190 mm	⑨
711.10.11	222 mm	⑪
711.10.13	254 mm	⑬
711.10.15	286 mm	⑮

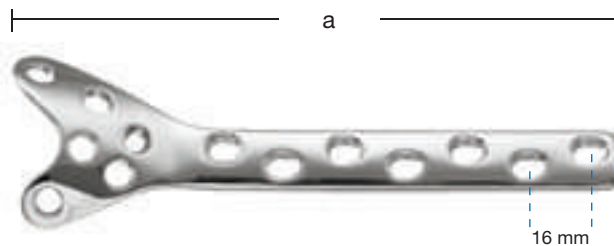

Kondylenabstützplatten, distal
 Condylar buttress plates, distal
 Placas condilares para apoyar, distal
 Plaques d'appui condilaire, distales
 Placche condilari per sostegno, distale



für rechtes Bein
 for right leg
 para pierna derecha
 pour jambe droite
 per gamba destra

	a	
711.11.07	158 mm	⑦
711.11.09	190 mm	⑨
711.11.11	222 mm	⑪
711.11.13	254 mm	⑬
711.11.15	286 mm	⑮

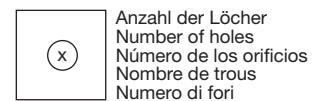
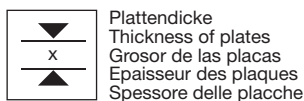



4.5

6.5

Großfragmentplatten
Large Fragment Plates
Placas para fragmentos grandes
Plaques pour grands fragments
Placche per frammenti grandi

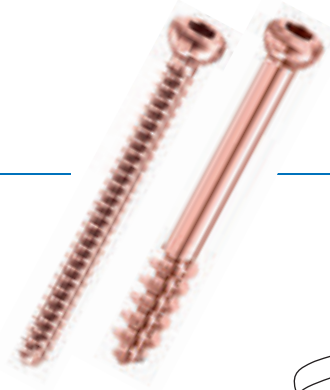

für Kortikalisschrauben **4,5 mm** und Spongiosaschrauben **6,5 mm**
 for cortical screws **4,5 mm** and spongiosa screws **6,5 mm**
 para tornillos corticales **4,5 mm** y tornillos esponjosos **6,5 mm**
 pour vis corticales **4,5 mm** et vis spongieuse **6,5 mm**
 per viti corticalis **4,5 mm** e viti spongiosa **6,5 mm**

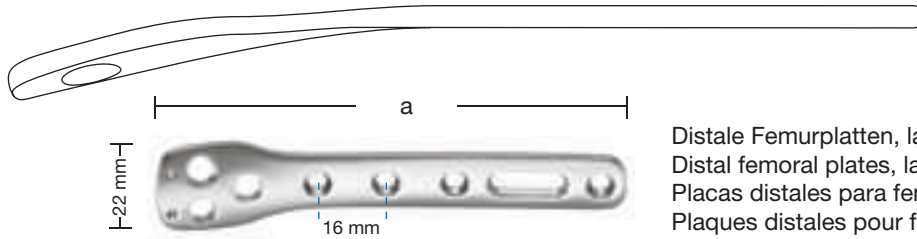

Distale Femurplatten, lateral
 Distal femoral plates, lateral
 Placas distales para femur, lateral
 Plaques distales pour femur, latérales
 Placche distali per femore, laterale

	3,2 mm	16 mm	a	
für linkes Bein for left leg para pierna izquierda pour jambe gauche per gamba sinistra				
			80 mm	⑤
			122 mm	⑦
			158 mm	⑨
			194 mm	⑪
			230 mm	⑬

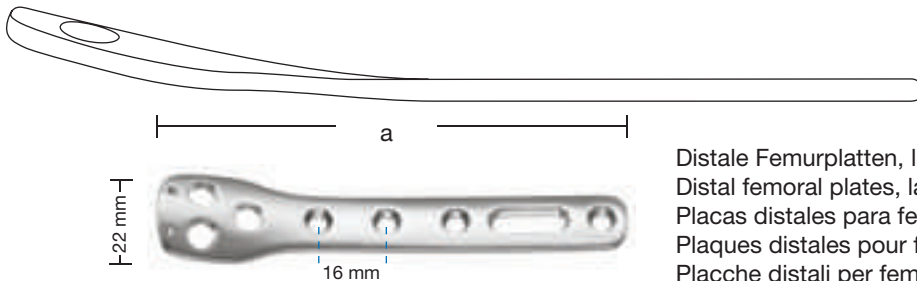

Distale Femurplatten, lateral
 Distal femoral plates, lateral
 Placas distales para femur, lateral
 Plaques distales pour femur, latérales
 Placche distali per femore, laterale

	3,2 mm	16 mm	a	
für rechtes Bein for right leg para pierna derecha pour jambe droite per gamba destra				
			80 mm	⑤
			122 mm	⑦
			158 mm	⑨
			194 mm	⑪
			230 mm	⑬

Plattendicke
 Thickness of plates
 Grosor de las placas
 Epaisseur des plaques
 Spessore delle placche

Plattenbreite
 Width of plates
 Ancho de la placa
 Largeur des plaques
 Larghezza delle placche

Anzahl der Löcher
 Number of holes
 Número de los orificios
 Nombre de trous
 Numero di fori



Großfragmentplatten
Large Fragment Plates
Placas para fragmentos grandes
Plaques pour grands fragments
Placche per frammenti grandi

4.5

6.5

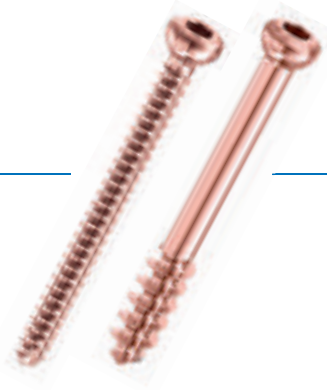

für Kortikalisschrauben **4,5 mm** und Spongiosaschrauben **6,5 mm**
 for cortical screws **4,5 mm** and spongiosa screws **6,5 mm**
 para tornillos corticales **4,5 mm** y tornillos esponjosos **6,5 mm**
 pour vis corticales **4,5 mm** et vis spongieuse **6,5 mm**
 per viti corticalis **4,5 mm** e viti spongiosa **6,5 mm**

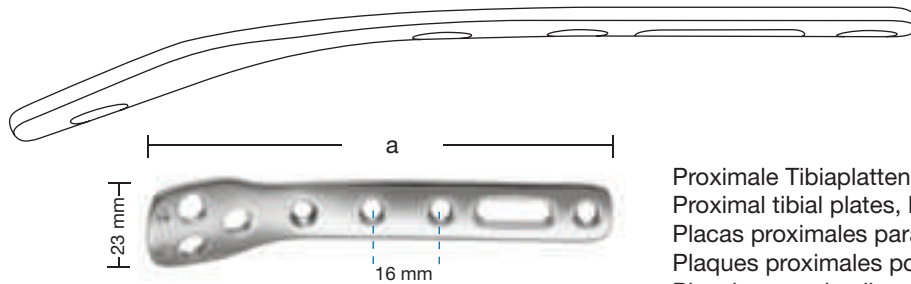

Proximale Tibiaplatten, lateral
 Proximal tibial plates, lateral
 Placas proximales para tibia, lateral
 Plaques proximales pour tibia, latérales
 Placche prossimali per tibia, laterale

	3,2 mm	16 mm	a	
für linkes Bein for left leg para pierna izquierda pour jambe gauche per gamba sinistra				
			711.14.05	80 mm (5)
			711.14.07	122 mm (7)
			711.14.09	158 mm (9)
			711.14.11	194 mm (11)
			711.14.13	230 mm (13)

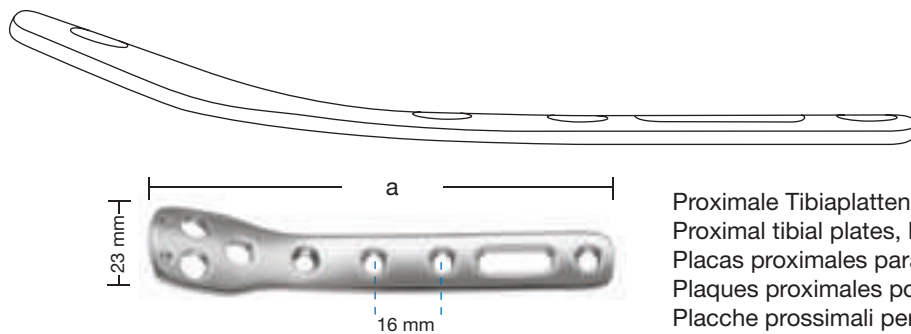

Proximale Tibiaplatten, lateral
 Proximal tibial plates, lateral
 Placas proximales para tibia, lateral
 Plaques proximales pour tibia, latérales
 Placche prossimali per tibia, laterale

	3,2 mm	16 mm	a	
für rechtes Bein for right leg para pierna derecha pour jambe droite per gamba destra				
			711.15.05	80 mm (5)
			711.15.07	122 mm (7)
			711.15.09	158 mm (9)
			711.15.11	194 mm (11)
			711.15.13	230 mm (13)

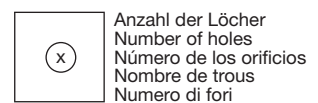
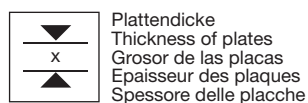



4.5

6.5

Großfragmentplatten
Large Fragment Plates
Placas para fragmentos grandes
Plaques pour grands fragments
Placche per frammenti grandi

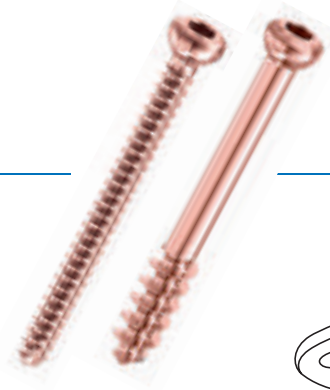

für Kortikalisschrauben **4,5 mm** und Spongiosaschrauben **6,5 mm**
 for cortical screws **4,5 mm** and spongiosa screws **6,5 mm**
 para tornillos corticales **4,5 mm** y tornillos esponjosos **6,5 mm**
 pour vis corticales **4,5 mm** et vis spongieuse **6,5 mm**
 per viti corticalis **4,5 mm** e viti spongiosa **6,5 mm**

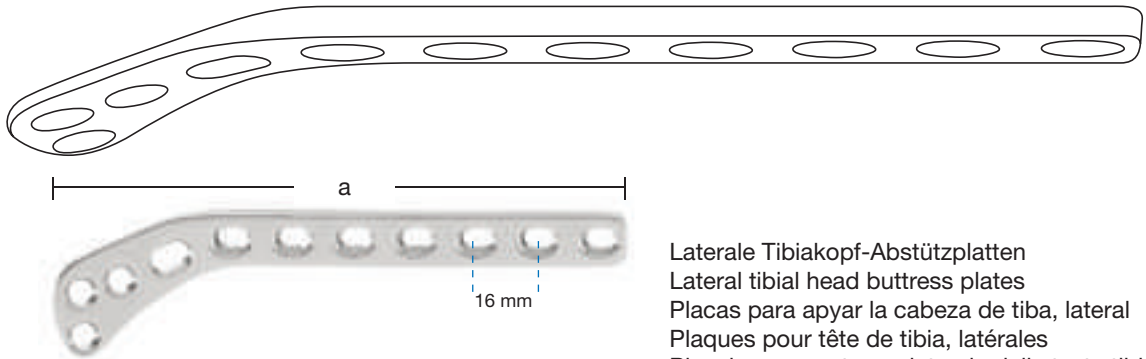

Laterale Tibiakopf-Abstützplatten
 Lateral tibial head buttress plates
 Placas para apyay la cabeza de tibia, lateral
 Plaques pour tête de tibia, latérales
 Placche per sostegno laterale della testa tibiale

	4,0 mm	14 mm	a	
links abgewinkelt (für rechtes Bein)			118 mm	⑤
angled left (for right leg)			149 mm	⑦
angulada hacia izquierda (para pierna derecha)			181 mm	⑨
coudée à gauche (pour jambe droite)			214 mm	⑪
angolato sinistro (per gamba destra)			246 mm	⑬

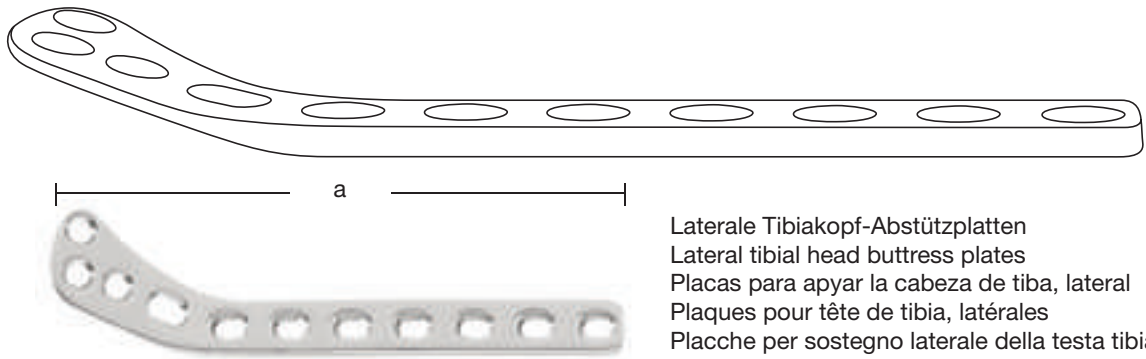

Laterale Tibiakopf-Abstützplatten
 Lateral tibial head buttress plates
 Placas para apyay la cabeza de tibia, lateral
 Plaques pour tête de tibia, latérales
 Placche per sostegno laterale della testa tibiale

	4,0 mm	14 mm	a	
rechts abgewinkelt (für linkes Bein)			118 mm	⑤
angled right (for left leg)			149 mm	⑦
angulada hacia derecha (para pierna izquierda)			181 mm	⑨
coudée à droite (pour jambe gauche)			214 mm	⑪
angolato destra (per gamba sinistra)			246 mm	⑬

Plattendicke
 Thickness of plates
 Grosor de las placas
 Epaisseur des plaques
 Spessore delle placche

Plattenbreite
 Width of plates
 Ancho de la placa
 Largeur des plaques
 Larghezza delle placche

Anzahl der Löcher
 Number of holes
 Número de los orificios
 Nombre de trous
 Numero di fori



Großfragmentplatten
Large Fragment Plates
Placas para fragmentos grandes
Plaques pour grands fragments
Placche per frammenti grandi

4.5**6.5**

für Kortikalisschrauben **4,5 mm** und Spongiosaschrauben **6,5 mm**
 for cortical screws **4,5 mm** and spongiosa screws **6,5 mm**
 para tornillos corticales **4,5 mm** y tornillos esponjosos **6,5 mm**
 pour vis corticales **4,5 mm** et vis spongieuse **6,5 mm**
 per viti corticalis **4,5 mm** e viti spongiosa **6,5 mm**

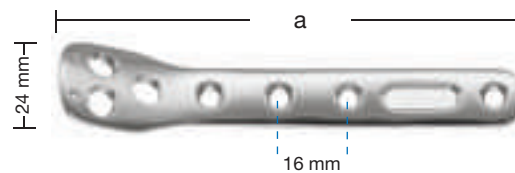
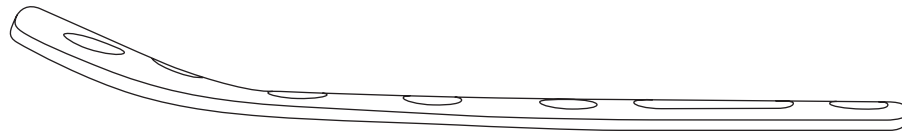

Distale Tibiaplatten, medial
 Distal tibial plates, medial
 Placas para tibia distal, medial
 Plaques distales pour tibia, médiales
 Placche per tibia distale, mediale

	3,2 mm	16 mm	a	
für linkes Bein for left leg para pierna izquierda pour jambe gauche per gamba sinistra			80 mm	⑤
			122 mm	⑦
			158 mm	⑨
			194 mm	⑪
			230 mm	⑬

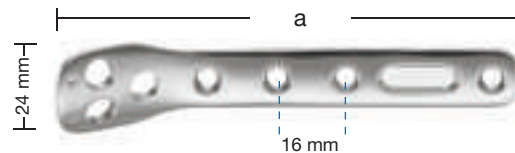
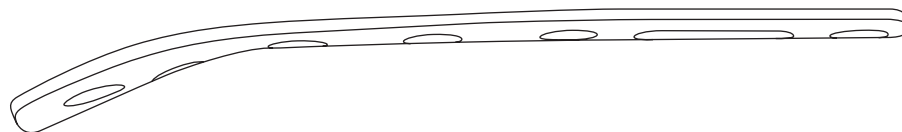

Distale Tibiaplatten, medial
 Distal tibial plates, medial
 Placas para tibia distal, medial
 Plaques distales pour tibia, médiales
 Placche per tibia distale, mediale

	2,0 mm	16 mm	a	
für rechtes Bein for right leg para pierna derecha pour jambe droite per gamba destra			80 mm	⑤
			122 mm	⑦
			158 mm	⑨
			194 mm	⑪
			230 mm	⑬

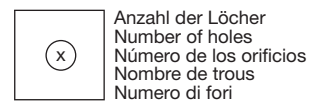
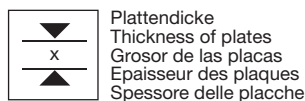



4.5

Großfragmentschrauben
Large Fragment Screws
Tornillos para fragmentos grandes
Vis pour grands fragments
Viti per frammenti grandi

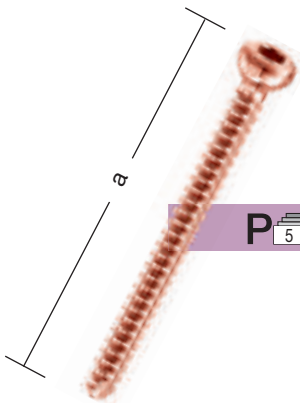

± 8,0 mm

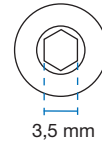

Kortikalisschrauben 4,5 mm
 Cortical screws 4,5 mm
 Tornillos corticales 4,5 mm
 Vis corticales 4,5 mm
 Viti corticalis 4,5 mm



a

		a
711.45.01	711.46.01	14 mm
711.45.02	711.46.02	16 mm
711.45.03	711.46.03	18 mm
711.45.04	711.46.04	20 mm
711.45.05	711.46.05	22 mm
711.45.06	711.46.06	24 mm
711.45.07	711.46.07	26 mm
711.45.08	711.46.08	28 mm
711.45.09	711.46.09	30 mm
711.45.10	711.46.10	32 mm
711.45.11	711.46.11	34 mm
711.45.12	711.46.12	36 mm
711.45.13	711.46.13	38 mm
711.45.14	711.46.14	40 mm
711.45.15	711.46.15	42 mm
711.45.16	711.46.16	44 mm
711.45.17	711.46.17	46 mm
711.45.18	711.46.18	48 mm
711.45.19	711.46.19	50 mm
711.45.20	711.46.20	52 mm
711.45.21	711.46.21	54 mm
711.45.22	711.46.22	56 mm
711.45.23	711.46.23	58 mm
711.45.24	711.46.24	60 mm
711.45.25	711.46.25	62 mm
711.45.26	711.46.26	64 mm
711.45.27	711.46.27	66 mm
711.45.28	711.46.28	68 mm
711.45.29	711.46.29	70 mm
711.45.30	711.46.30	72 mm
711.45.31	711.46.31	74 mm
711.45.32	711.46.32	76 mm
711.45.33	711.46.33	78 mm
711.45.34	711.46.34	80 mm
711.45.35	711.46.35	85 mm
711.45.36	711.46.36	90 mm
711.45.37	711.46.37	95 mm
711.45.38	711.46.38	100 mm
711.45.39	711.46.39	105 mm
711.45.40	711.46.40	110 mm
711.45.41	711.46.41	115 mm
711.45.42	711.46.42	120 mm
711.45.43	711.46.43	125 mm
711.45.44	711.46.44	130 mm
711.45.45	711.46.45	135 mm
711.45.46	711.46.46	140 mm



4,5 mm



3,0 mm

Gewindesteigung 1,75 mm
 Thread pitch 1,75 mm
 Paso de rosca 1,75 mm
 Distance entre filetage de 1,75 mm
 Passo del filetto 1,75 mm

Bohrer für Gewindeloch 3,2 mm siehe Seite 76
 Drills for threaded hole 3,2 mm see page 76
 Brocas para orificio roscado 3,2 mm vea la página 76
 Forets pour trou fileté de 3,2 mm voir page 76
 Perforatori per foro filettato 3,2 mm vedi pagina 76

Bohrer für Gleitloch 4,5 mm siehe Seite 76
 Drills for sliding hole 4,5 mm see page 76
 Brocas para orificio de deslizamiento 4,5 mm vea la página 76
 Forets pour trou lisse de 4,5 mm voir page 76
 Perforatori per foro di scorrimento 4,5 mm vedi pagina 76

Gewindeschneider 4,5 mm siehe Seite 76
 Taps 4,5 mm see page 76
 Roscadores 4,5 mm veáase página 76
 Tarauds 4,5 mm voir page 76
 Filettatori 4,5 mm vedi pagina 76



Verpackungseinheit "X" Stück
 Packing unit "X" pieces
 Paquete de "X" unidades
 Emballage de "X" pièces
 Confezione da "X" pezzi



selbstschneidend
 self-tapping
 rosca cortante
 autotaraudeuse
 autofilettanti



Standard
 Standard
 Estándar
 Standard
 Standard



Großfragmentschrauben
Large Fragment Screws
Tornillos para fragmentos grandes
Vis pour grands fragments
Viti per frammenti grandi

6.5

1:1

8,0 mm

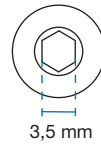

Spongiaschrauben **6,5 mm**
 Spongiosa screws **6,5 mm**
 Tornillos esponjosos **6,5 mm**
 Vis spongieuse **6,5 mm**
 Viti spongiosa **6,5 mm**

P₅

a

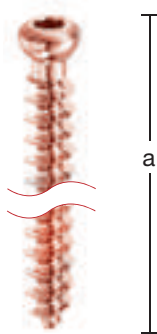

711.65.01	25 mm
711.65.02	30 mm
711.65.03	35 mm
711.65.04	40 mm
711.65.05	45 mm
711.65.06	50 mm
711.65.07	55 mm
711.65.08	60 mm
711.65.09	65 mm
711.65.10	70 mm
711.65.11	75 mm
711.65.12	80 mm
711.65.13	85 mm
711.65.14	90 mm
711.65.15	95 mm
711.65.16	100 mm
711.65.17	105 mm
711.65.18	110 mm
711.65.19	115 mm
711.65.20	120 mm
711.65.21	125 mm
711.65.22	130 mm



6,5 mm



3,0 mm

Gewindesteigung 2,75 mm
 Thread pitch 2,75 mm
 Paso de rosca 2,75 mm
 Distance entre filetage de 2,75 mm
 Passo del filetto 2,75 mm

Bohrer für Gewindeloch 3,2 mm siehe Seite 76
 Drills for threaded hole 3,2 mm see page 76
 Brocas para orificio roscado 3,2 mm vea la página 76
 Forets pour trou fileté de 3,2 mm voir page 76
 Perforatori per foro filettato 3,2 mm vedi pagina 76

Gewindeschneider 6,5 mm siehe Seite 77
 Tap 6,5 mm see page 77
 Roscador 6,5 mm vea página 77
 Taraud 6,5 mm voir page 77
 Filettatore 6,5 mm vedi pagina 77



Verpackungseinheit "X" Stück
 Packing unit "X" pieces
 Paquete de "X" unidades
 Emballage de "X" pièces
 Confezione da "X" pezzi



Vollgewinde
 Full thread
 Rosca completa
 Filetage complet
 Filetto completo



6.5

Großfragmentschrauben
Large Fragment Screws
Tornillos para fragmentos grandes
Vis pour grands fragments
Viti per frammenti grandi



8,0 mm

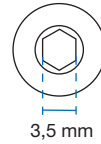

Spongiaschrauben 6,5 mm
 Spongiosa screws 6,5 mm
 Tornillos esponjosos 6,5 mm
 Vis spongieuse 6,5 mm
 Viti spongiosa 6,5 mm

1:1



a

711.66.01		30 mm
711.66.02		35 mm
711.66.03		40 mm
711.66.04	711.67.01	45 mm
711.66.05	711.67.02	50 mm
711.66.06	711.67.03	55 mm
711.66.07	711.67.04	60 mm
711.66.08	711.67.05	65 mm
711.66.09	711.67.06	70 mm
711.66.10	711.67.07	75 mm
711.66.11	711.67.08	80 mm
711.66.12	711.67.09	85 mm
711.66.13	711.67.10	90 mm
711.66.14	711.67.11	95 mm
711.66.15	711.67.12	100 mm
711.66.16	711.67.13	105 mm
711.66.17	711.67.14	110 mm
711.66.18	711.67.15	115 mm
711.66.19	711.67.16	120 mm
711.66.20	711.67.17	125 mm
711.66.21	711.67.18	130 mm
711.66.22	711.67.19	135 mm
711.66.23	711.67.20	140 mm
	711.67.21	145 mm
	711.67.22	150 mm

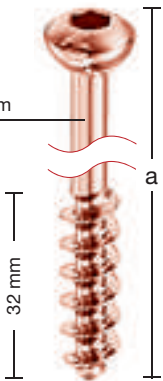
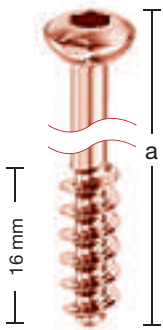

6,5 mm



3,0 mm

Gewindesteigung 2,75 mm
 Thread pitch 2,75 mm
 Paso de rosca 2,75 mm
 Distance entre filetage de 2,75 mm
 Passo del filetto 2,75 mm

Bohrer für Gewindeloch 3,2 mm siehe Seite 76
 Drills for threaded hole 3,2 mm see page 76
 Brocas para orificio roscado 3,2 mm vea la página 76
 Forets pour trou fileté de 3,2 mm voir page 76
 Perforatori per foro filettato 3,2 mm vedi pagina 76

Bohrer für Schaft 4,5 mm siehe Seite 76
 Drills for shaft 4,5 mm see page 76
 Brocas para vástago 4,5 mm vea página 76
 Forets pour tige 4,5 mm voir page 76
 Perforatori per asta 4,5 mm vedi pagina 76

Gewindeschneider 6,5 mm siehe Seite 77
 Tap 6,5 mm see page 77
 Roscador 6,5 mm vea página 77
 Taraud 6,5 mm voir page 77
 Filettatore 6,5 mm vedi pagina 77

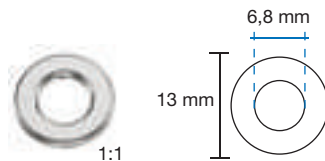

1:1

Unterlegscheibe für Spongiaschrauben 6,5 mm
 Washer for spongiosa screws 6,5 mm
 Arandela para tornillos esponjosos 6,5 mm
 Rondelle pour vis spongieuse 6,5 mm
 Rondella per viti spongiosa 6,5 mm



711.00.01



Verpackungseinheit "X" Stück
 Packing unit "X" pieces
 Paquete de "X" unidades
 Emballage de "X" pièces
 Confezione da "X" pezzi



Teilgewinde
 Partial thread
 Rosca parcial
 Filetage partiel
 Filetto parziale



Großfragmentschrauben
Large Fragment Screws
Tornillos para fragmentos grandes
Vis pour grands fragments
Viti per frammenti grandi

4.5

Malleolarschrauben **4,5 mm**
 Malleolar screws **4,5 mm**
 Tornillos para maléolo **4,5 mm**
 Vis pour malléole **4,5 mm**
 Viti per malleolari **4,5 mm**

P 5



a

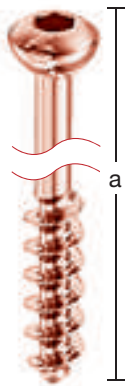

711.47.01	20 mm
711.47.02	25 mm
711.47.03	30 mm
711.47.04	35 mm
711.47.05	40 mm
711.47.06	45 mm
711.47.07	50 mm
711.47.08	55 mm
711.47.09	60 mm
711.47.10	65 mm
711.47.11	70 mm
711.47.12	75 mm
711.47.13	80 mm



4,5 mm



3,0 mm

Gewindesteigung 1,75 mm
 Thread pitch 1,75 mm
 Paso de rosca 1,75 mm
 Distance entre filetage de 1,75 mm
 Passo 1,75 mm

Bohrer für Gewindeloch 3,2 mm siehe Seite 76
 Drills for threaded hole 3,2 mm see page 76
 Brocas para orificio roscado 3,2 mm vea la página 76
 Forets pour trou fileté de 3,2 mm voir page 76
 Perforatori per foro filettato 3,2 mm vedi pagina 76

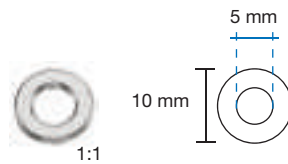

Unterlegscheibe für Malleolarschrauben 4,5 mm
 Washer for malleolar screws 4,5 mm
 Arandela para tornillos para maléolo 4,5 mm
 Rondelle pour vis malléole 4,5 mm
 Rondella per viti malleolari 4,5 mm

P 5

711.00.00

Verpackungseinheit "X" Stück
 Packing unit "X" pieces
 Paquete de "X" unidades
 Emballage de "X" pièces
 Confezione da "X" pezzi



Teilgewinde
 Partial thread
 Rosca parcial
 Filetage partiel
 Filetto parziale

4.5

6.5

Großfragment-Instrumentarium
Large Fragment Instrumentation
Instrumental para fragmentos grandes
Instruments pour grands fragments
Strumenti per frammenti grandi

Übersicht Schraubendreher, Klingen und Haltehülsen für Schrauben
 Overview screwdrivers, blades and holding sleeves for screws
 Vista general de atornilladores, hojas y vainas para tornillos
 Aperçu tournevis, lames et douilles pour tenir les vis
 Visione generale del cacciavite, lame e boccole per viti

für Kortikalisschrauben 4,5 mm, Spongiaschrauben 6,5 mm und Malleolarschrauben 4,5 mm
for cortical screws 4,5 mm, spongiosa screws 6,5 mm and malleolar screws 4,5 mm
para tornillos corticales 4,5 mm, tornillos esponjosos 6,5 mm y tornillos para maléolo 4,5 mm
pour vis corticales 4,5 mm, vis spongieuses 6,5 mm et vis pour malléole 4,5 mm
per viti corticalis 4,5 mm, viti spongiosa 6,5 mm e viti per malleolari 4,5 mm

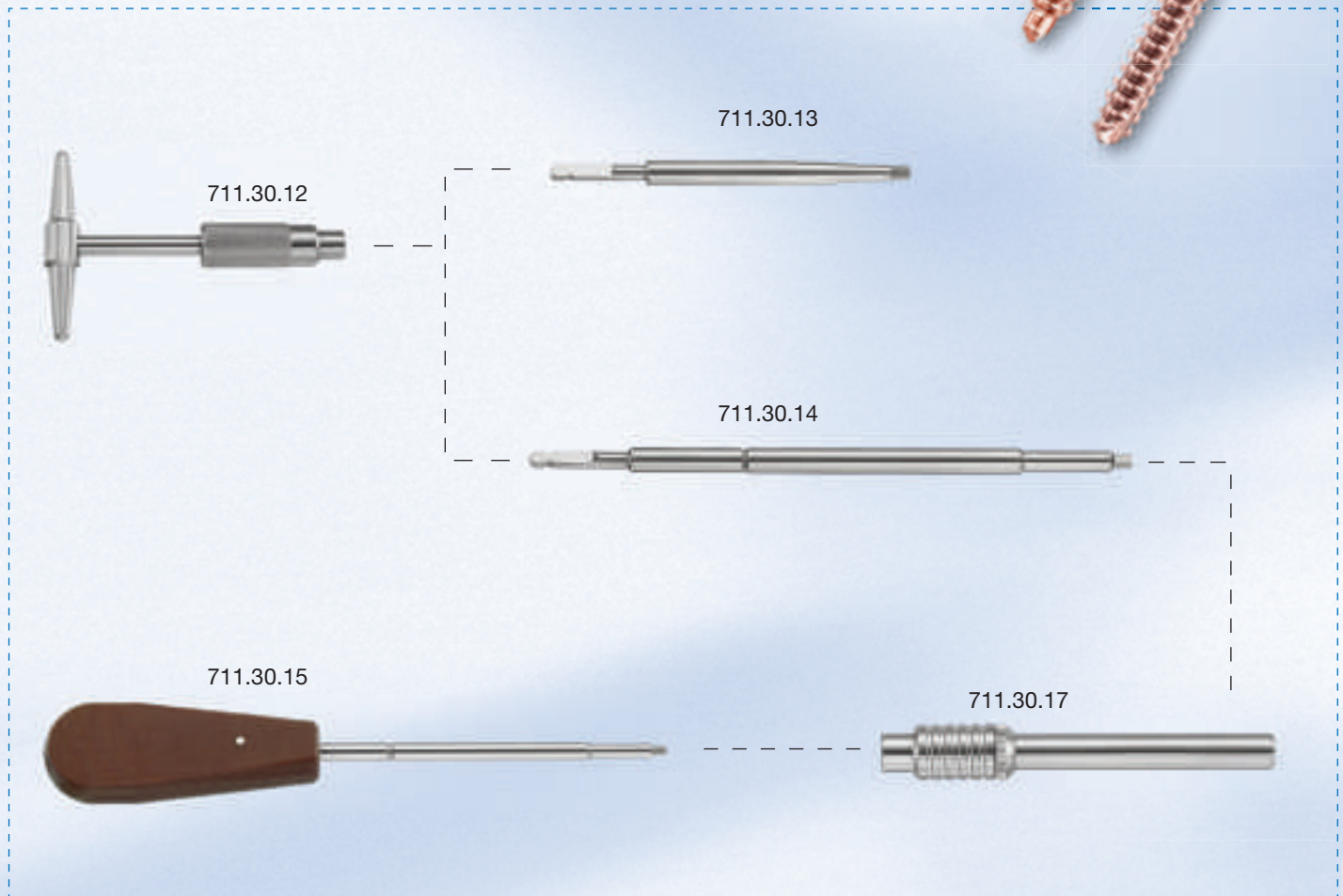



Großfragment-Instrumentarium
Large Fragment Instrumentation
Instrumental para fragmentos grandes
Instruments pour grands fragments
Strumenti per frammenti grandi

4.5

6.5

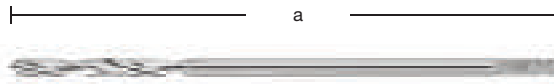

Bohrer für Schnellkupplung
 Drills for quick coupling
 Brocas para acoplamiento rápido
 Forets pour accouplement rapide
 Perforatori per accoppiamento rapido

	a	Ø
711.30.18	145 mm	3,2 mm
711.30.19	195 mm	3,2 mm
711.30.20	145 mm	4,5 mm
711.30.21	195 mm	4,5 mm

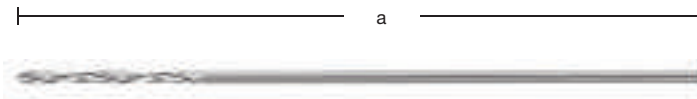

Bohrer für Dreibackenspannfutter
 Drills for three-jaw chuck
 Brocas para plato de tres mordazas
 Forets pour mandrin à trois mâchoires
 Perforatori per mandrino a tre ganasce

	a	Ø
711.30.22	85 mm	2,0 mm
711.30.23	130 mm	3,2 mm
711.30.24	180 mm	3,2 mm
711.30.25	130 mm	4,5 mm
711.30.26	180 mm	4,5 mm



Gewindeschneider für Schnellkupplung
 Tap for quick coupling
 Roscador para acoplamiento rápido
 Taraud pour accouplement rapide
 Filettatore per accoppiamento rapido

	Ø
711.30.29	4,5 mm

für Kortikalisschrauben
 for cortical screws
 para tornillos corticales
 pour vis corticales
 per viti corticalis



4.5

6.5

Großfragment-Instrumentarium
Large Fragment Instrumentation
Instrumental para fragmentos grandes
Instruments pour grands fragments
Strumenti per frammenti grandi

kalibriert
 calibrated
 calibrado
 calibré
 calibrato

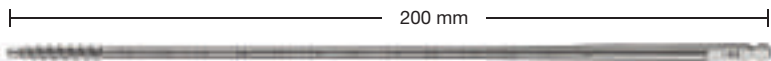

Gewindeschneider für Schnellkupplung
 Tap for quick coupling
 Roscador para acoplamiento rápido
 Taraud pour accouplement rapide
 Filettatore per accoppiamento rapido

	Ø	
für Spongiosaschrauben for spongiosa screws para tornillos esponjosos pour vis spongieuse per viti spongiosa	711.30.30	6,5 mm

kalibriert
 calibrated
 calibrado
 calibré
 calibrato



Gewindeschneider für Schnellkupplung
 Tap for quick coupling
 Roscador para acoplamiento rápido
 Taraud pour accouplement rapide
 Filettatore per accoppiamento rapido

	Ø	
für Kortikalisschrauben for cortical screws para tornillos corticales pour vis corticales per viti corticalis	711.30.31	4,5 mm

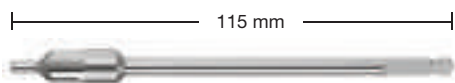

Kopfraumfräser für Schnellkupplung
 Countersink for quick coupling
 Fresa para acoplamiento rápido
 Fraise pour accouplement rapide
 Fresa per accoppiamento rapido

für Schrauben Ø 4,5 / 6,5 mm for screws Ø 4,5 / 6,5 mm para tornillos Ø 4,5 / 6,5 mm pour vis Ø 4,5 / 6,5 mm per viti Ø 4,5 / 6,5 mm	711.30.27	
--	------------------	--

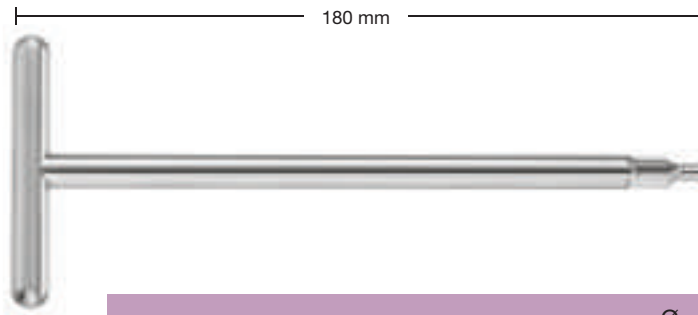

Großfragment-Instrumentarium
Large Fragment Instrumentation
Instrumental para fragmentos grandes
Instruments pour grands fragments
Strumenti per frammenti grandi

4.5**6.5**

Kopfraumfräser mit Griff
 Countersink with handle
 Fresa con mango
 Fraise avec manche
 Fresa con manico

	Ø
für Schrauben Ø 4,5 / 6,5 mm for screws Ø 4,5 / 6,5 mm para tornillos Ø 4,5 / 6,5 mm pour vis Ø 4,5 / 6,5 mm per viti Ø 4,5 / 6,5 mm	711.30.28 4,5 / 6,5 mm





Steckbohrbuchse
 Insert drill sleeve
 Casquillo de inserción
 Fixation douille de forage
 Centrapunta retta

711.30.07



Doppelbohrbuchse
 Double drill sleeve
 Casquillo de taladrar doble
 Double douille de forage
 Bussola di foratura doppia

		
711.30.08	Ø 4,5 mm	Ø 3,2 mm



für Gewindeschneider
 for taps
 para roscadores
 pour tarauds
 per filettatori



für Bohrer
 for drills
 para brocas
 pour forets
 per perforatori





4.5

6.5

Großfragment-Instrumentarium
Large Fragment Instrumentation
Instrumental para fragmentos grandes
Instruments pour grands fragments
Strumenti per frammenti grandi





Doppelbohrbuchse
 Double drill sleeve
 Casquillo de taladrar doble
 Double douille de forage
 Bussola di foratura doppia

		
711.30.09	Ø 6,5 mm	Ø 3,2 mm





Universalbohrbuchse
 Universal drill sleeve
 Casquillo de taladrar universal
 Douille de forage universelle
 Centrapunta universale

		
711.30.10	Ø 4,5 mm	Ø 3,2 mm



Bohrbuchse neutral und exzentrisch
 Drill sleeve neutral and excentric
 Casquillo de taladrar neutral y excéntrico
 Douille de forage neutre et excentrique
 Bussola di foratura neutrale e eccentrica

		
711.30.11	Ø 3,2 mm	Ø 4,5 mm



für Gewindeschneider
 for taps
 para roscadores
 pour tarauds
 per filettatori



für Bohrer
 for drills
 para brocas
 pour forets
 per perforatori



für Schrauben
 for screws
 para tornillos
 pour vis
 per viti



Großfragment-Instrumentarium
Large Fragment Instrumentation
Instrumental para fragmentos grandes
Instruments pour grands fragments
Strumenti per frammenti grandi

4.5**6.5**

Plattenspanner mit Kraftanzeige
Plate tensioner with gauge
Extensor de placa con indicación de fuerza
Plaque à tension avec jauge
Tenditore di placca con indicatore di forza

710.30.25

Ring-/Gabelschlüssel 11 mm
Combination wrench 11 mm
Llave bifurcada/anular 11 mm
Clé torse combination 11 mm
Chiave anello/forchetta 11 mm

710.30.26

Kardanschlüssel 11 mm
Cardan wrench 11 mm
Llave cardan 11 mm
Clé torse cardan 11 mm
Chiave cardan 11 mm

711.30.32



4.5

6.5

Großfragment-Instrumentarium
Large Fragment Instrumentation
Instrumental para fragmentos grandes
Instruments pour grands fragments
Strumenti per frammenti grandi



T-Griff, klein, mit Schnellkupplung
 T-handle, small, with quick coupling
 Mango en T, pequeño, con acoplamiento rápido
 Manche en T, petit, avec accouplement rapide
 Manico a T, piccolo, con accoppiamento rapido

711.30.12



Schraubendrehereinsatz Sechskant
 Screwdriver insert hexagonal
 Inserto para atornillador hexagonal
 Insert de tournevis hexagonal
 Inserto per cacciavite esagonale

711.30.13

für Schnellkupplung
 for quick coupling
 para acoplamiento rápido
 pour accouplement rapide
 per accoppiamento rapido



Schraubendrehereinsatz Sechskant
 Screwdriver insert hexagonal
 Inserto para atornillador hexagonal
 Insert de tournevis hexagonal
 Inserto per cacciavite esagonale

711.30.14

für Schnellkupplung
 for quick coupling
 para acoplamiento rápido
 pour accouplement rapide
 per accoppiamento rapido



Großfragment-Instrumentarium
Large Fragment Instrumentation
Instrumental para fragmentos grandes
Instruments pour grands fragments
Strumenti per frammenti grandi

4.5

6.5

3,5 mm



Schraubendreher Sechskant
 Screwdriver hexagonal
 Atornillador hexagonal
 Tournevis hexagonal
 Cacciavite esagonale

**711.30.15**24,5 cm - 9³/₄"

Haltehülse für Schrauben
 Holding sleeve for screws
 Vaina para tornillos
 Douille pour tenir les vis
 Boccola per viti

für Schrauben Ø 4,5 / 6,5 mm
 for screws Ø 4,5 / 6,5 mm
 para tornillos Ø 4,5 / 6,5 mm
 pour vis Ø 4,5 / 6,5 mm
 per viti Ø 4,5 / 6,5 mm

711.30.17

Bohrlochtiefenlehre
 Depth gauge for drill-holes
 Instrumento para medir la profundidad
 Instrument pour mesurer la profondeur
 Strumento per misurare la profondità

für Schrauben Ø 4,5 / 6,5 mm
 for screws Ø 4,5 / 6,5 mm
 para tornillos Ø 4,5 / 6,5 mm
 pour vis Ø 4,5 / 6,5 mm
 per viti Ø 4,5 / 6,5 mm

711.30.06

Biegeeisen für Standardplatten
 Bending lever for standard plates
 Palanca para doblar placas estándar
 Levier de pliage pour plaques standards
 Leva piegaplacche per placche standard

711.30.00

Kunststoffgriff (autoklavierbar bis 134 °C bei 3 bar)
 Plastic handle (autoclavable up to 134 °C at 3 bar)
 Mango de plástico (autoclavable hasta 134 °C bajo presión de 3 bar)
 Manche en plastique (autoclavable à 134 °C sous pression de 3 bars)
 Manico di plastica (autoclavabile fino a 134 °C sotto pressione di 3 bar)



4.5

6.5

Großfragment-Instrumentarium
Large Fragment Instrumentation
Instrumental para fragmentos grandes
Instruments pour grands fragments
Strumenti per frammenti grandi



1:3

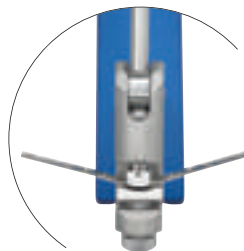

Biegepresse für Knochenplatten
 Bending device for bone plates
 Prensa para placas de hueso
 Presse pour plier les plaques à os
 Piegatrice per placche per ossa

75.49.70

440 x 80 mm

Mit dieser Biegepresse können Knochenplatten bis zu einer Dicke von 6 mm ohne großen Kraftaufwand gebogen werden. Die Platten können sowohl konvex als auch konkav ohne Schädigung der Platte gebogen werden.

With this bending device bone-plates up to a thickness of 6 mm can be bent easily without applying much force. The plates can be bent convex or concave and will not be damaged.

Con esta prensa se puede moldear placas de hueso hasta un grosor de 6 mm sin mucha fuerza. Se puede moldear las placas tanto concavas como convexas sin dañar las mismas.

A l'aide de cette presse pour plier les plaques à os, des plaques d'une épaisseur jusqu'à 6 mm peuvent être pliées sans beaucoup de forces. Il est possible de plier les plaques de façon concave ou convexe sans les endommager.

Con questa piegatrice possono essere piegate delle placche per ossa con uno spessore di 6 mm senza grande dispendio di forza. Le placche possono essere piegate in modo convesso come anche concavo senza danneggiare la placca.



Biegeschablonen 4,5 mm
 Bending templates 4,5 mm
 Placas de premoldeación 4,5 mm
 Plaques de préformation 4,5 mm
 Placche sagomabili 4,5 mm

711.30.01

⑤

711.30.02

⑦

711.30.03

⑨

711.30.04

⑫



Anzahl der Löcher
 Number of holes
 Número de los orificios
 Nombre de trous
 Numero di fori

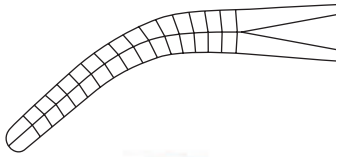

Großfragment-Instrumentarium
Large Fragment Instrumentation
Instrumental para fragmentos grandes
Instruments pour grands fragments
Strumenti per frammenti grandi

4.5**6.5**

Knochenhaltezange
 Bone holding forceps
 Pinza para huesos
 Davier à os
 Tenaglia per ossa

35.14.2222 cm - 8³/₄"

Reinigungshaken
 Cleaning hook
 Gancho para limpieza
 Crochet pour nettoyage
 Uncino per pulizia

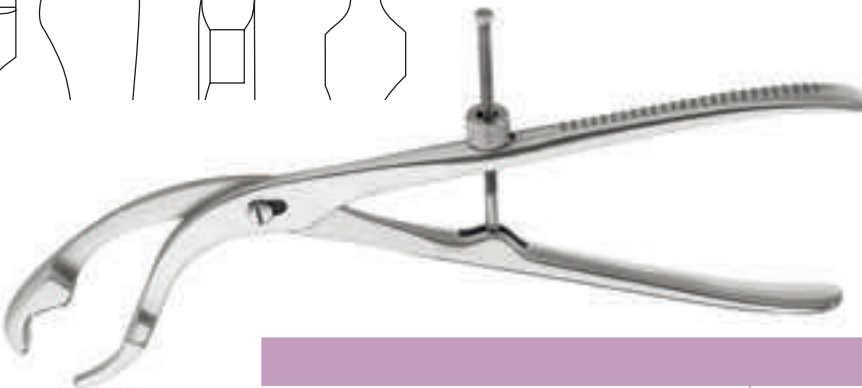
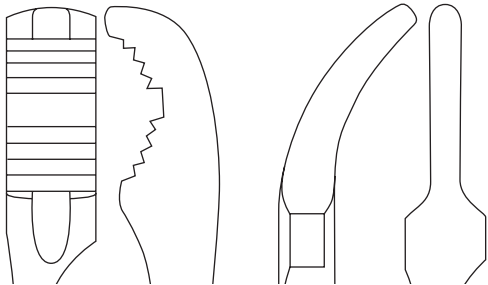
351.64.0116 cm - 6¹/₄"

Knochenhaltezangen, selbstzentrierend
 Bone holding forceps, self-centering
 Pinzas para huesos, autocentrando
 Daviers à os, autocentrant
 Tenaglie per ossa, autocentrante

Verbrugge**35.76.24**24 cm - 9¹/₂"**35.76.26**26 cm - 10¹/₄"**35.76.28**

28 cm - 11"

ORTHO PAEDICS

IMPLANTS AND INSTRUMENTS

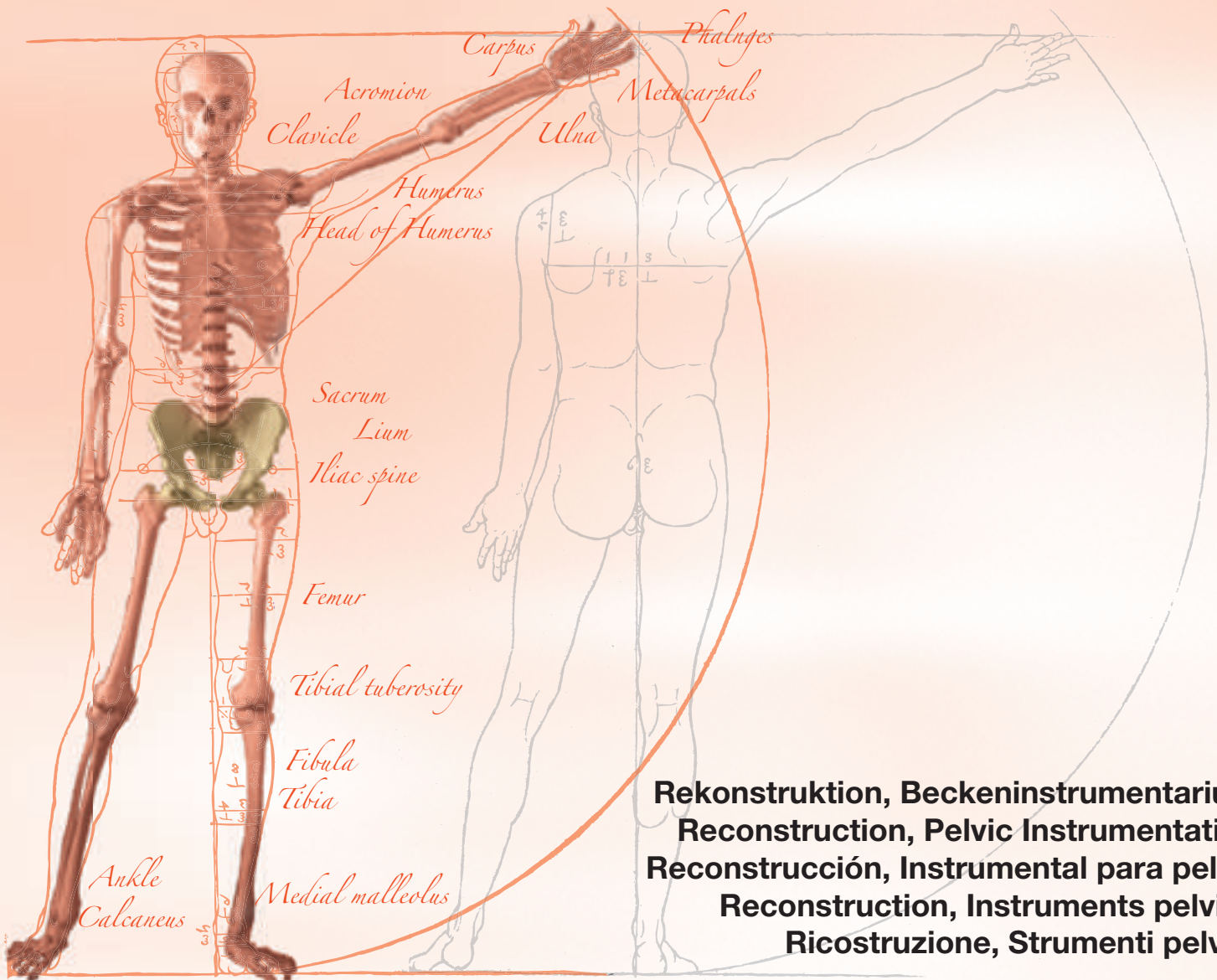

Rekonstruktion, Beckeninstrumentarium
Reconstruction, Pelvic Instrumentation
Reconstrucción, Instrumental para pelvis
Reconstruction, Instruments pelvins
Ricostruzione, Strumenti pelvici



Rekonstruktion
Reconstruction
Reconstrucción
Reconstruction
Ricostruzione

3.5**4.0**

für Kortikalisschrauben **3,5 mm** und Spongiosaschrauben **4,0 mm**
 for cortical screws **3,5 mm** and spongiosa screws **4,0 mm**
 para tornillos corticales **3,5 mm** y tornillos esponjosos **4,0 mm**
 pour vis corticales **3,5 mm** et vis spongieuses **4,0 mm**
 per viti corticalis **3,5 mm** e per viti spongiosa **4,0 mm**

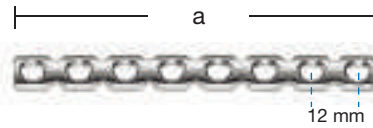
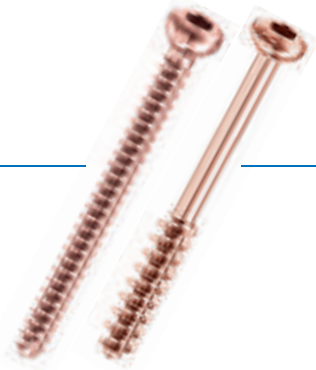

Rekonstruktionsplatten
 Reconstruction plates
 Placas de reconstrucción
 Plaques de reconstruction
 Placche di ricostruzione

	$\frac{2,9 \text{ mm}}{\text{▲▼}}$	10 mm	a	
gerade				③
straight			713.00.03 34 mm	
recta			713.00.04 46 mm	④
droite			713.00.05 58 mm	⑤
retta			713.00.06 70 mm	⑥
			713.00.07 82 mm	⑦
			713.00.08 94 mm	⑧
			713.00.09 106 mm	⑨
			713.00.10 118 mm	⑩
			713.00.11 130 mm	⑪
			713.00.12 142 mm	⑫
			713.00.13 154 mm	⑬
			713.00.14 166 mm	⑭
			713.00.15 178 mm	⑮
			713.00.16 190 mm	⑯
			713.00.18 214 mm	⑰

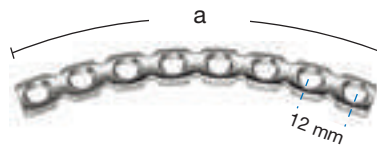

Rekonstruktionsplatten
 Reconstruction plates
 Placas de reconstrucción
 Plaques de reconstruction
 Placche di ricostruzione

	$\frac{3,6 \text{ mm}}{\text{▲▼}}$	10 mm	a	
gebogen				⑥
curved			713.01.06 70 mm	
curvada			713.01.08 94 mm	⑧
courbées			713.01.10 118 mm	⑩
curva			713.01.12 142 mm	⑫
			713.01.14 166 mm	⑭
			713.01.16 190 mm	⑯
			713.01.18 214 mm	⑰

$\frac{\text{▲▼}}{\text{x}}$
 Plattendicke
 Thickness of plates
 Grosor de las placas
 Epaisseur des plaques
 Spessore delle placche

10 mm
 Plattenbreite
 Width of plates
 Ancho de la placa
 Larghezza delle placche

③
 Anzahl der Löcher
 Number of holes
 Número de los orificios
 Nombre de trous
 Numero di fori

4.5

6.5

Rekonstruktion
Reconstruction
Reconstrucción
Reconstruction
Ricostruzione

für Kortikalisschrauben 4,5 mm und Spongiaschrauben 6,5 mm
for cortical screws 4,5 mm and spongiosa screws 6,5 mm
para tornillos corticales 4,5 mm y tornillos esponjosos 6,5 mm
pour vis corticales 4,5 mm et vis spongieuses 6,5 mm
per viti corticalis 4,5 mm e viti spongiosa 6,5 mm

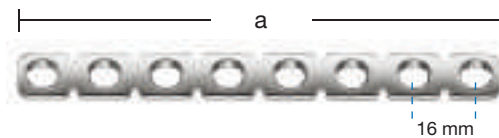
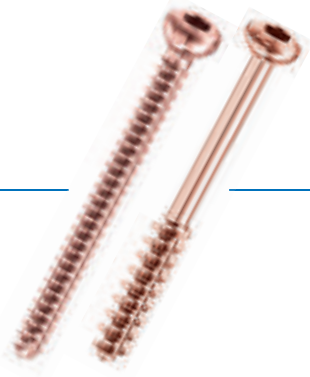

Rekonstruktionsplatten
Reconstruction plates
Placas de reconstrucción
Plaques de reconstruction
Placche di ricostruzione

	2,9 mm	12 mm	a		
gerade					
straight					
recta					
droite					
retta					
			713.02.03	45 mm	③
			713.02.04	61 mm	④
			713.02.05	77 mm	⑤
			713.02.06	93 mm	⑥
			713.02.07	109 mm	⑦
			713.02.08	125 mm	⑧
			713.02.09	141 mm	⑨
			713.02.10	157 mm	⑩
			713.02.11	173 mm	⑪
			713.02.12	189 mm	⑫
			713.02.13	205 mm	⑬
			713.02.14	221 mm	⑭
			713.02.15	237 mm	⑮
			713.02.16	253 mm	⑯

Plattendicke
 Thickness of plates
 Grosor de las placas
 Epaisseur des plaques
 Spessore delle placche

Plattenbreite
 Width of plates
 Ancho de la placa
 Largeur des plaques
 Larghezza delle placche

Anzahl der Löcher
 Number of holes
 Número de los orificios
 Nombre de trous
 Numero di fori

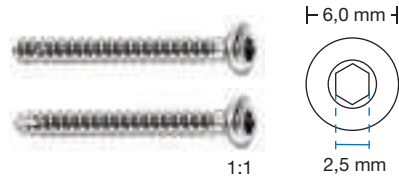
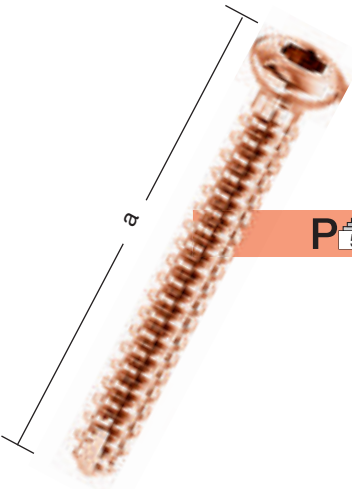

Rekonstruktion
Reconstruction
Reconstrucción
Reconstruction
Ricostruzione

3.5

Kortikalisschrauben **3,5 mm**
 Cortical screws **3,5 mm**
 Tornillos corticales **3,5 mm**
 Vis corticales **3,5 mm**
 Viti corticalis **3,5 mm**

P

		a
710.35.01	710.36.01	10 mm
710.35.02	710.36.02	12 mm
710.35.03	710.36.03	14 mm
710.35.04	710.36.04	16 mm
710.35.05	710.36.05	18 mm
710.35.06	710.36.06	20 mm
710.35.07	710.36.07	22 mm
710.35.08	710.36.08	24 mm
710.35.09	710.36.09	26 mm
710.35.10	710.36.10	28 mm
710.35.11	710.36.11	30 mm
710.35.12	710.36.12	32 mm
710.35.13	710.36.13	34 mm
710.35.14	710.36.14	36 mm
710.35.15	710.36.15	38 mm
710.35.16	710.36.16	40 mm
710.35.17	710.36.17	45 mm
710.35.18	710.36.18	50 mm
710.35.19	710.36.19	55 mm
710.35.20	710.36.20	60 mm
710.35.21	710.36.21	65 mm
710.35.22	710.36.22	70 mm
710.35.23	710.36.23	75 mm
710.35.24	710.36.24	80 mm
710.35.25	710.36.25	85 mm
710.35.26	710.36.26	90 mm
710.35.27	710.36.27	95 mm
710.35.28	710.36.28	100 mm
710.35.29	710.36.29	105 mm
710.35.30	710.36.30	110 mm
710.35.31	710.36.31	115 mm
710.35.32	710.36.32	120 mm



3,5 mm



2,4 mm

Gewindesteigung 1,25 mm
 Thread pitch 1,25 mm
 Paso de rosca 1,25 mm
 Distance entre filetage de 1,25 mm
 Passo del filetto 1,25 mm

Bohrer für Gewindeloch 2,5 mm siehe Seite 93
 Drill for threaded hole 2,5 mm see page 93
 Broca para orificio roscado 2,5 mm vea la página 93
 Foret pour trou fileté de 2,5 mm voir page 93
 Perforatore per foro filettato 2,5 mm vedi pagina 93

Bohrer für Gleitloch 3,5 mm siehe Seite 93
 Drill for sliding hole 3,5 mm see page 93
 Broca para orificio de deslizamiento 3,5 mm vea la página 93
 Foret pour trou lisse de 3,5 mm voir page 93
 Perforatore per foro di scorrimento 3,5 mm vedi pagina 93

Gewindeschneider 3,5 mm siehe Seite 93
 Tap 3,5 mm see page 93
 Roscador 3,5 mm vea página 93
 Taraud 3,5 mm voir page 93
 Filettatore 3,5 mm vedi pagina 93



Verpackungseinheit "X" Stück
 Packing unit "X" pieces
 Paquete de "X" unidades
 Emballage de "X" pièces
 Confezione da "X" pezzi



selbstschneidend
 self-tapping
 rosca cortante
 autotaraudeuse
 autofilettanti



Standard
 Standard
 Estándar
 Standard
 Standard

4.0

Rekonstruktion
Reconstruction
Reconstrucción
Reconstruction
Ricostruzione



Spongiosaschrauben 4,0 mm
Spongiosa screws 4,0 mm
Tornillos esponjosos 4,0 mm
Vis spongieuse 4,0 mm
Viti spongiosa 4,0 mm

P₅



a



a

b

710.40.01	10 mm	710.41.01	10 mm	5 mm
710.40.02	12 mm	710.41.02	12 mm	5 mm
710.40.03	14 mm	710.41.03	14 mm	5 mm
710.40.04	16 mm	710.41.04	16 mm	6 mm
710.40.05	18 mm	710.41.05	18 mm	7 mm
710.40.06	20 mm	710.41.06	20 mm	8 mm
710.40.07	22 mm	710.41.07	22 mm	9 mm
710.40.08	24 mm	710.41.08	24 mm	10 mm
710.40.09	26 mm	710.41.09	26 mm	12 mm
710.40.10	28 mm	710.41.10	28 mm	14 mm
710.40.11	30 mm	710.41.11	30 mm	14 mm
710.40.12	32 mm	710.41.12	32 mm	14 mm
710.40.13	34 mm	710.41.13	34 mm	14 mm
710.40.14	36 mm	710.41.14	36 mm	14 mm
710.40.15	38 mm	710.41.15	38 mm	14 mm
710.40.16	40 mm	710.41.16	40 mm	14 mm
710.40.17	42 mm	710.41.17	42 mm	16 mm
710.40.18	44 mm	710.41.18	44 mm	16 mm
710.40.19	46 mm	710.41.19	46 mm	16 mm
710.40.20	48 mm	710.41.20	48 mm	16 mm
710.40.21	50 mm	710.41.21	50 mm	16 mm
710.40.22	55 mm	710.41.22	55 mm	16 mm
710.40.23	60 mm	710.41.23	60 mm	16 mm

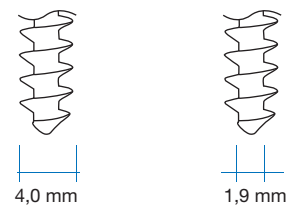
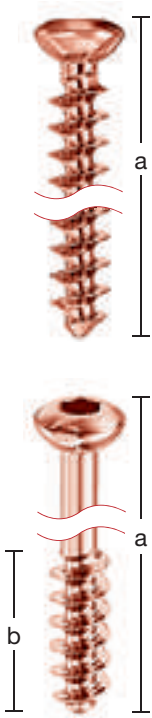

Gewindesteigung 1,75 mm
Thread pitch 1,75 mm
Paso de rosca 1,75 mm
Distance entre filetage de 1,75 mm
Passo del filetto 1,75 mm

Bohrer für Gewindeloch 2,5 mm siehe Seite 93
Drill for threaded hole 2,5 mm see page 93
Broca para orificio roscado 2,5 mm vea la página 93
Foret pour trou fileté de 2,5 mm voir page 93
Perforatore per foro filettato 2,5 mm vedi pagina 93

Gewindeschneider 4,0 mm siehe Seite 52
Tap 4,0 mm see page 52
Roscador 4,0 mm vea página 52
Taraud 4,0 mm voir page 52
Filettatore 4,0 mm vedi pagina 52



Unterlegscheibe für Spongiosaschrauben 4,0 mm
Washer for spongiosa screws 4,0 mm
Arandela para tornillos esponjosos 4,0 mm
Rondelle pour vis spongieuse 4,0 mm
Rondella per viti spongiosa 4,0 mm

P₅

710.00.00



Verpackungseinheit "X" Stück
Packing unit "X" pieces
Paquete de "X" unidades
Emballage de "X" pièces
Confezione da "X" pezzi



Vollgewinde
Full thread
Rosca completa
Filetage complet
Filetto totale



Teilgewinde
Partial thread
Rosca parcial
Filetage partiel
Filetto parziale

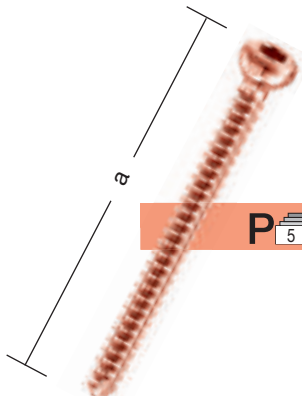

Rekonstruktion
Reconstruction
Reconstrucción
Reconstruction
Ricostruzione

4.5

| 8,0 mm |

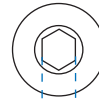

1:1

3,5 mm

Kortikalisschrauben 4,5 mm
 Cortical screws 4,5 mm
 Tornillos corticales 4,5 mm
 Vis corticales 4,5 mm
 Viti corticalis 4,5 mm

P₅

a

		a
711.45.01	711.46.01	14 mm
711.45.02	711.46.02	16 mm
711.45.03	711.46.03	18 mm
711.45.04	711.46.04	20 mm
711.45.05	711.46.05	22 mm
711.45.06	711.46.06	24 mm
711.45.07	711.46.07	26 mm
711.45.08	711.46.08	28 mm
711.45.09	711.46.09	30 mm
711.45.10	711.46.10	32 mm
711.45.11	711.46.11	34 mm
711.45.12	711.46.12	36 mm
711.45.13	711.46.13	38 mm
711.45.14	711.46.14	40 mm
711.45.15	711.46.15	42 mm
711.45.16	711.46.16	44 mm
711.45.17	711.46.17	46 mm
711.45.18	711.46.18	48 mm
711.45.19	711.46.19	50 mm
711.45.20	711.46.20	52 mm
711.45.21	711.46.21	54 mm
711.45.22	711.46.22	56 mm
711.45.23	711.46.23	58 mm
711.45.24	711.46.24	60 mm
711.45.25	711.46.25	62 mm
711.45.26	711.46.26	64 mm
711.45.27	711.46.27	66 mm
711.45.28	711.46.28	68 mm
711.45.29	711.46.29	70 mm
711.45.30	711.46.30	72 mm
711.45.31	711.46.31	74 mm
711.45.32	711.46.32	76 mm
711.45.33	711.46.33	78 mm
711.45.34	711.46.34	80 mm
711.45.35	711.46.35	85 mm
711.45.36	711.46.36	90 mm
711.45.37	711.46.37	95 mm
711.45.38	711.46.38	100 mm
711.45.39	711.46.39	105 mm
711.45.40	711.46.40	110 mm
711.45.41	711.46.41	115 mm
711.45.42	711.46.42	120 mm
711.45.43	711.46.43	125 mm
711.45.44	711.46.44	130 mm
711.45.45	711.46.45	135 mm
711.45.46	711.46.46	140 mm



4,5 mm



3,0 mm

Gewindesteigung 1,75 mm
 Thread pitch 1,75 mm
 Paso de rosca 1,75 mm
 Distance entre filetage de 1,75 mm
 Passo del filetto 1,75 mm

Bohrer für Gewindeloch 3,2 mm siehe Seite 93
 Drill for threaded hole 3,2 mm see page 93
 Broca para orificio roscado 3,2 mm vea la página 93
 Foret pour trou fileté de 3,2 mm voir page 93
 Perforatore per foro filettato 3,2 mm vedi pagina 93

Bohrer für Gleitloch 4,5 mm siehe Seite 93
 Drills for sliding hole 4,5 mm see page 93
 Brocas para orificio de deslizamiento 4,5 mm vea la página 93
 Forets pour trou lisse de 4,5 mm voir page 93
 Perforatori per foro di scorrimento 3,5 mm vedi pagina 93

Gewindeschneider 4,5 mm siehe Seite 93
 Tap 4,5 mm see page 93
 Roscador 4,5 mm vea página 93
 Taraud 4,5 mm voir page 93
 Filettatore 4,5 mm vedi pagina 93



Verpackungseinheit "X" Stück
 Packing unit "X" pieces
 Paquete de "X" unidades
 Emballage de "X" pièces
 Confezione da "X" pezzi



selbstschneidend
 self-tapping
 rosca cortante
 autotaraudeuse
 autofilettanti



Standard
 Standard
 Estándar
 Standard
 Standard

6.5

**Rekonstruktion
Reconstruction
Reconstrucción
Reconstruction
Ricostruzione**

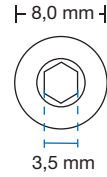

Spongiaschrauben 6,5 mm
Spongiosa screws 6,5 mm
Tornillos esponjosos 6,5 mm
Vis spongieuse 6,5 mm
Viti spongiosa 6,5 mm

1:1



a

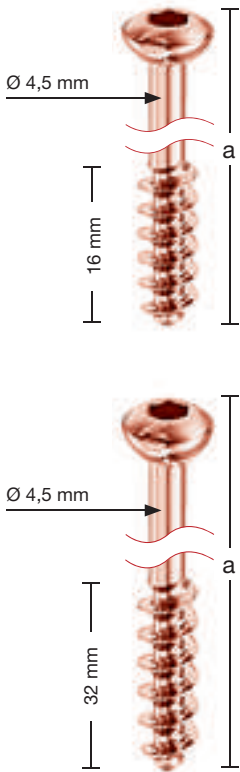

711.66.01		30 mm
711.66.02		35 mm
711.66.03		40 mm
711.66.04	711.67.01	45 mm
711.66.05	711.67.02	50 mm
711.66.06	711.67.03	55 mm
711.66.07	711.67.04	60 mm
711.66.08	711.67.05	65 mm
711.66.09	711.67.06	70 mm
711.66.10	711.67.07	75 mm
711.66.11	711.67.08	80 mm
711.66.12	711.67.09	85 mm
711.66.13	711.67.10	90 mm
711.66.14	711.67.11	95 mm
711.66.15	711.67.12	100 mm
711.66.16	711.67.13	105 mm
711.66.17	711.67.14	110 mm
711.66.18	711.67.15	115 mm
711.66.19	711.67.16	120 mm
711.66.20	711.67.17	125 mm
711.66.21	711.67.18	130 mm
711.66.22	711.67.19	135 mm
711.66.23	711.67.20	140 mm
	711.67.21	145 mm
	711.67.22	150 mm



6,5 mm



3,0 mm

Gewindesteigung 2,75 mm
Thread pitch 2,75 mm
Paso de rosca 2,75 mm
Distance entre filetage de 2,75 mm
Passo del filetto 2,75 mm

Bohrer für Gewindeloch 3,2 mm siehe Seite 93
Drill for threaded hole 3,2 mm see page 93
Broca para orificio roscado 3,2 mm vea la página 93
Foret pour trou fileté de 3,2 mm voir page 93
Perforatore per foro filettato 3,2 mm vedi pagina 93

Bohrer für Gleitloch 4,5 mm siehe Seite 93
Drills for sliding hole 4,5 mm see page 93
Brocas para orificio de deslizamiento 4,5 mm vea la página 93
Forets pour trou lisse de 4,5 mm voir page 93
Perforatori per foro di scorrimento 3,5 mm vedi pagina 93

Gewindeschneider 6,5 mm siehe Seite 77
Tap 6,5 mm see page 77
Roscador 6,5 mm vea página 77
Taraud 6,5 mm voir page 77
Filettatore 6,5 mm vedi pagina 77

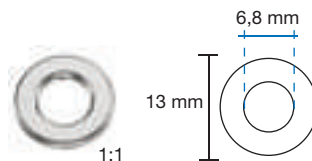

1:1

Unterlegscheibe für Spongiaschrauben 6,5 mm
Washer for spongiosa screws 6,5 mm
Arandela para tornillos esponjosos 6,5 mm
Rondelle pour vis spongieuse 6,5 mm
Rondella per viti spongiosa 6,5 mm



711.00.01



Verpackungseinheit "X" Stück
Packing unit "X" pieces
Paquete de "X" unidades
Emballage de "X" pièces
Confezione da "X" pezzi



Teilgewinde
Partial thread
Rosca parcial
Filetage partiel
Filetto parziale



Rekonstruktion
Reconstruction
Reconstrucción
Reconstruction
Ricostruzione

6.5

Spongiosaschrauben 6,5 mm
 Spongiosa screws 6,5 mm
 Tornillos esponjosos 6,5 mm
 Vis spongieuses 6,5 mm
 Viti spongiosa 6,5 mm

P



a

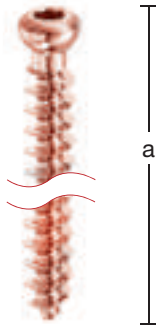

711.65.01	25 mm
711.65.02	30 mm
711.65.03	35 mm
711.65.04	40 mm
711.65.05	45 mm
711.65.06	50 mm
711.65.07	55 mm
711.65.08	60 mm
711.65.09	65 mm
711.65.10	70 mm
711.65.11	75 mm
711.65.12	80 mm
711.65.13	85 mm
711.65.14	90 mm
711.65.15	95 mm
711.65.16	100 mm
711.65.17	105 mm
711.65.18	110 mm
711.65.19	115 mm
711.65.20	120 mm
711.65.21	125 mm
711.65.22	130 mm

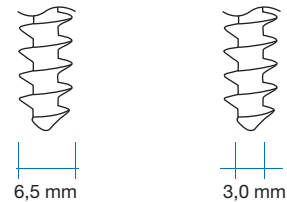

Gewindesteigung 2,75 mm
 Thread pitch 2,75 mm
 Paso de rosca 2,75 mm
 Distance entre filetage de 2,75 mm
 Passo del filetto 2,75 mm

Bohrer für Gewindeloch 3,2 mm siehe Seite 93
 Drill for threaded hole 3,2 mm see page 93
 Broca para orificio roscado 3,2 mm vea la página 93
 Foret pour trou fileté de 3,2 mm voir page 93
 Perforatore per foro filettato 3,2 mm vedi pagina 93

Gewindeschneider 6,5 mm siehe Seite 77
 Tap 6,5 mm see page 77
 Roscador 6,5 mm vea página 77
 Taraud 6,5 mm voir page 77
 Filettatore 6,5 mm vedi pagina 77

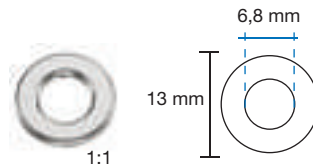

Unterlegscheibe für Spongiosa schrauben 6,5 mm
 Washer for spongiosa screws 6,5 mm
 Arandela para tornillos esponjosos 6,5 mm
 Rondelle pour vis spongieuse 6,5 mm
 Rondella per viti spongiosa 6,5 mm

P

711.00.01

Verpackungseinheit "X" Stück
 Packing unit "X" pieces
 Paquete de "X" unidades
 Emballage de "X" pièces
 Confezione da "X" pezzi



Vollgewinde
 Full thread
 Rosca completa
 Filetage complet
 Filetto completo

3.5

4.0

4.5

6.5

Beckeninstrumentarium
Pelvic Instrumentation
Instrumental para pelvis
Instruments pelvis
Strumenti pelvici



Bohrer für Schnellkupplung
 Drills for quick coupling
 Brocas para acoplamiento rápido
 Forets pans pour accouplement rapide
 Perforatori per accoppiamento rapido

	a	Ø
dreischneidig three-fluted edged corte triplicada trois pans tre tagli	713.30.00	230 mm 2,5 mm
	713.30.01	230 mm 3,2 mm
	713.30.02	195 mm 4,5 mm

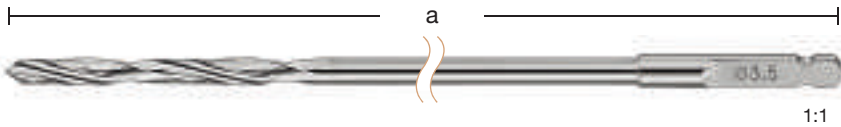

Bohrer für Schnellkupplung
 Drill for quick coupling
 Broca para acoplamiento rápido
 Foret pour accouplement rapide
 Perforatore per accoppiamento rapido

	a	Ø
	710.30.17	195 mm 3,5 mm

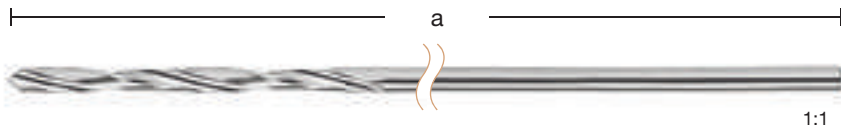

Bohrer für Dreibackenspannfutter
 Drills for three-jaw chuck
 Brocas para plato de tres mordazas
 Forets pour mandrin à trois mâchoires
 Perforatori per mandrino a tre ganasce

	a	Ø
	711.30.24	180 mm 3,2 mm
	711.30.26	180 mm 4,5 mm

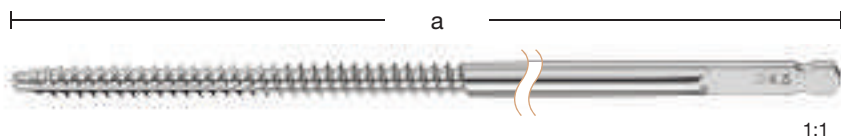

Gewindeschneider für Schnellkupplung
 Taps for quick coupling
 Roscadores para acoplamiento rápido
 Tarauds pour accouplement rapide
 Filettatori per accoppiamento rapido

	a	Ø
für Kortikalisschrauben Ø 3,5 / 4,5 mm for cortical screws Ø 3,5 / 4,5 mm para tornillos corticales Ø 3,5 / 4,5 mm pour vis corticales Ø 3,5 / 4,5 mm per viti corticalis Ø 3,5 / 4,5 mm	710.30.21	110 mm 3,5 mm
	711.30.29	125 mm 4,5 mm



Beckeninstrumentarium
Pelvic Instrumentation
Instrumental para pelvis
Instruments pelvis
Strumenti pelvici

3.5

4.0

4.5

6.5



T-Griff, klein, mit Schnellkupplung
T-Handle, small, with quick coupling
Mango en T, pequeño, con acoplamiento rápido
Manche en T, petit, avec accouplement rapide
Manico a T, piccolo, con accoppiamento rapido

711.30.12

3,5 mm



Schraubendreher Sechskant
Screwdriver hexagonal
Atornillador hexagonal
Tournevis hexagonal
Cacciavite esagonale



711.30.16

30 cm - 11³/₄"

2,5 mm



Schraubendreher Sechskant
Screwdriver hexagonal
Atornillador hexagonal
Tournevis hexagonal
Cacciavite esagonale



709.30.16

27 cm - 10³/₄"



Kunststoffgriff (autoklavierbar bis 134 °C bei 3 bar)
Plastic handle (autoclavable up to 134 °C at 3 bar)
Mango de plástico (autoclavable hasta 134 °C bajo presión de 3 bar)
Manche en plastique (autoclavable à 134 °C sous pression de 3 bars)
Manico di plastica (autoclavabile fino a 134 °C sotto pressione di 3 bar)

3.5 **4.0** **4.5** **6.5**

Beckeninstrumentarium
Pelvic Instrumentation
Instrumental para pelvis
Instruments pelvins
Strumenti pelvici



Schraubendrehereinsatz Sechskant
 Screwdriver insert hexagonal
 Inserto para atornillador hexagonal
 Insert de tournevis hexagonal
 Inserto per cacciavite esagonale

für Schnellkupplung
 for quick coupling
 para acoplamiento rápido
 pour accouplement rapide
 per accoppiamento rapido

709.30.14 16,5 cm - 6½"



Schraubendrehereinsatz Sechskant
 Screwdriver insert hexagonal
 Inserto para atornillador hexagonal
 Insert de tournevis hexagonal
 Inserto per cacciavite esagonale

für Schnellkupplung
 for quick coupling
 para acoplamiento rápido
 pour accouplement rapide
 per accoppiamento rapido

711.30.14 16,5 cm - 6½"



Haltehülse für Schrauben
 Holding sleeve for screws
 Vaina para tornillos
 Douille pour tenir les vis
 Boccia per viti

für Schrauben Ø 3,5 / 4,0 mm
 for screws Ø 3,5 / 4,0 mm
 para tornillos Ø 3,5 / 4,0 mm
 pour vis Ø 3,5 / 4,0 mm
 per viti Ø 3,5 / 4,0 mm

710.30.12



Haltehülse für Schrauben
 Holding sleeve for screws
 Vaina para tornillos
 Douille pour tenir les vis
 Boccia per viti

für Schrauben Ø 4,5 / 6,5 mm
 for screws Ø 4,5 / 6,5 mm
 para tornillos Ø 4,5 / 6,5 mm
 pour vis Ø 4,5 / 6,5 mm
 per viti Ø 4,5 / 6,5 mm

711.30.17



Beckeninstrumentarium
Pelvic Instrumentation
Instrumental para pelvis
Instrumenti pelvini

3.5**4.0****4.5****6.5**

Bohrlochtiefenlehre
 Depth gauge for drill-holes
 Instrumento para medir la profundidad
 Instrument pour mesurer la profondeur
 Strumenti per misurare la profondità, grande

für Schrauben Ø 4,5 / 6,5 mm
 for screws Ø 4,5 / 6,5 mm
 para tornillos Ø 4,5 / 6,5 mm
 pour vis Ø 4,5 / 6,5 mm
 per viti Ø 4,5 / 6,5 mm

711.30.06

Biegeeisen für Rekonstruktionsplatten
 Bending lever for reconstruction plates
 Palanca para doblar placas de reconstrucción
 Levier de pliage pour plaques de reconstruction
 Leva piegaplacche per placche di ricostruzione

für Platten 3,5 / 4,5 mm
 for plates 3,5 / 4,5 mm
 para placas 3,5 / 4,5 mm
 pour plaques 3,5 / 4,5 mm
 per placche 3,5 / 4,5 mm

713.30.13

Biegezange für Rekonstruktionsplatten
 Bending pliers for reconstruction plates
 Pinza para doblar placas de reconstrucción
 Pince de pliage pour plaques de reconstruction
 Leva piegaplacche per placche di ricostruzione

713.30.14

24 cm - 9½"

3.5

4.0

4.5

6.5

Beckeninstrumentarium
Pelvic Instrumentation
Instrumental para pelvis
Instruments pelvins
Strumenti pelvici

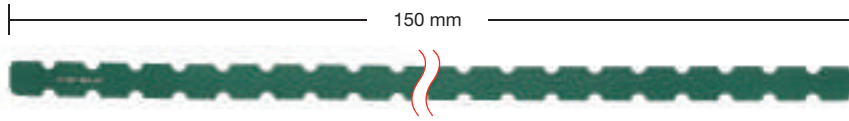

Biegeschablone für Rekonstruktionsplatten
 Bending template for reconstruction plates
 Placa de premoldeación para placas de reconstrucción
 Plaque de préformation pour plaques reconstruction
 Placca sagomabile per placche di ricostruzione

gerade, für Platten 3,5 mm
 straight, for plates 3,5 mm
 recta, para placas 3,5 mm
 droite, pour plaques 3,5 mm
 retta, per placche 3,5 mm

713.30.15



Biegeschablone für Rekonstruktionsplatten
 Bending template for reconstruction plates
 Placa de premoldeación para placas de reconstrucción
 Plaque de préformation pour plaques reconstruction
 Placca sagomabile per placche di ricostruzione

gebogen, für Platten 3,5 mm
 curved, for plates 3,5 mm
 curva, para placas 3,5 mm
 courbée, pour plaques 3,5 mm
 curva, per placche 3,5 mm

713.30.16



Biegeschablone für Rekonstruktionsplatten
 Bending template for reconstruction plates
 Placa de premoldeación para placas de reconstrucción
 Plaque de préformation pour plaques reconstruction
 Placca sagomabile per placche di ricostruzione

gerade, für Platten 4,5 mm
 straight, for plates 4,5 mm
 recta, para placas 4,5 mm
 droite, pour plaques 4,5 mm
 retta, per placche 4,5 mm

713.30.17



Beckeninstrumentarium
Pelvic Instrumentation
Instrumental para pelvis
Instruments pelvins
Strumenti pelvici

3.5**4.0****4.5****6.5**

Repositionszange, groß
 Reposition forceps, large
 Pinza para reposición, grande
 Pince à reposition, grand
 Pinza di riposizione, grande

713.30.05

20 cm - 8"



1:3

Beckenrepositionszange für Schrauben
 Pelvic reposition forceps for screws
 Pinza de reposición de pelvis para tornillos
 Pince à reposition pelvienne pour vis
 Pinza di riposizione pelvica per viti

713.30.0634 cm - 13 $\frac{3}{8}$ "

Beckenrepositionszange abgewinkelt
 Pelvic reposition forceps angled
 Pinza angulada para reposición de pelvis
 Pince coudée à reposition pelvienne
 Pinza angolata per riposizione pelvica

713.30.0719 cm - 7 $\frac{1}{2}$ "

3.5

4.0

4.5

6.5

Beckeninstrumentarium
Pelvic Instrumentation
Instrumental para pelvis
Instruments pelvins
Strumenti pelvici



Beckenrepositionszange abgewinkelt
 Pelvic reposition forceps angled
 Pinza angulada para reposicionar pelvis
 Pince coudée à reposition pelvienne
 Pinza angolata per riposizione pelvica

713.30.08

24 cm - 9½"



Beckenrepositionszange
 Pelvic reposition forceps
 Pinza para reposicionar pelvis
 Pince à reposition pelvienne
 Pinza per riposizione pelvica

713.30.10

25 cm - 10"

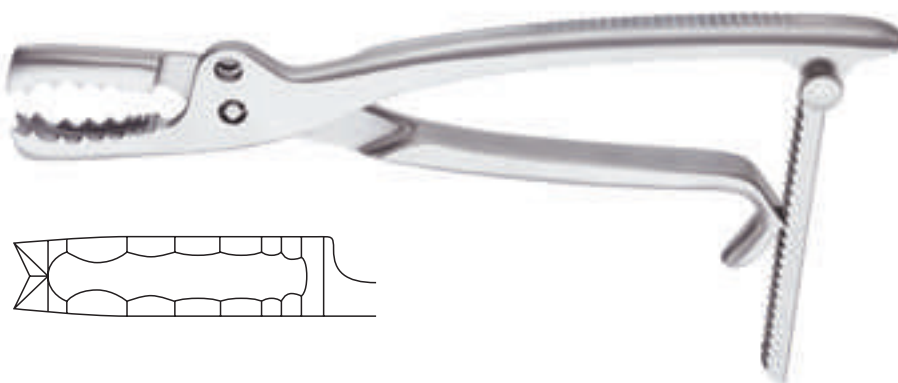

Beckenrepositionszange abgewinkelt
 Pelvic reposition forceps angled
 Pinza angulada para reposicionar pelvis
 Pince coudée à reposition pelvienne
 Pinza angolata per riposizione pelvica

Farabeuf-Lambotte

35.64.96

26 cm - 10¼"



Beckeninstrumentarium
Pelvic Instrumentation
Instrumental para pelvis
Instruments pelvins
Strumenti pelvici

3.5**4.0****4.5****6.5**

1:4

Beckenrepositionszange, groß
 Pelvic reposition forceps, large
 Pinza para repositionar pelvis, grande
 Pince à reposition pelvienne, grand
 Pinza per riposizione pelvica, grande

713.30.0940 cm - 15³/₄"

1:4

Beckenrepositionszange 1 x 2 Spitzen
 Pelvic reposition forceps 1 x 2 tips
 Pinza para repositionar pelvis 1 x 2 puntas
 Pince à reposition pelvienne 1 x 2 dents
 Pinza per riposizione pelvica 1 x 2 denti

713.30.1140 cm - 15³/₄"

1:4

Beckenrepositionszange asymmetrisch
 Pelvic reposition forceps asymmetric
 Pinza para repositionar pelvis asimétrica
 Pince à reposition pelvienne asymétrique
 Pinza per riposizione pelvica asimetrica

713.30.1240 cm - 15³/₄"

3.5

4.0

4.5

6.5

Beckeninstrumentarium
Pelvic Instrumentation
Instrumental para pelvis
Instruments pelvins
Strumenti pelvici



1:1

Abstützplatte für Repositionszangen
 Support plate for reposition forceps
 Placa de apoyo para pinzas de reposición
 Plaque d'appui pour pinces de reposition
 Placca di sostegno per pinze di riposizione

713.30.04

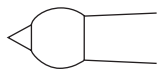

Knochenhaltestab
 Bone holding device
 Barra para sujetar huesos
 Barreau pour os
 Barra per osso

713.30.03

30 cm - 11³/₄"

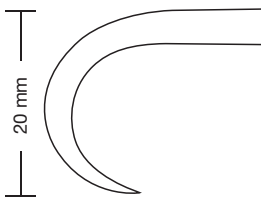

Wundhaken
 Retractor
 Separador
 Ecarteur
 Divaricatore

Volkmann

22.34.01

22 cm - 8³/₄"



Kunststoffgriff (autoklavierbar bis 134 °C bei 3 bar)
 Plastic handle (autoclavable up to 134 °C at 3 bar)
 Mango de plástico (autoclavable hasta 134 °C bajo presión de 3 bar)
 Manche en plastique (autoclavable à 134 °C sous pression de 3 bars)
 Manico di plastica (autoclavabile fino a 134 °C sotto pressione di 3 bar)

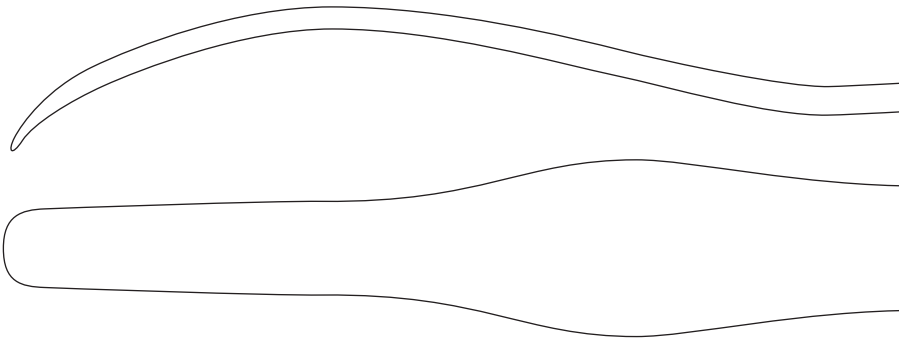

Beckeninstrumentarium
Pelvic Instrumentation
Instrumental para pelvis
Instruments pelvins
Strumenti pelvici

3.5**4.0****4.5****6.5**

Beckenhebel
 Pelvis lever
 Palanca para pelvis
 Levier à pelvienne
 Elevatore pelvico

77.12.5427 cm - 10³/₄"

Schraube Ø 6 mm, Trokarspitze flach
 Screw Ø 6 mm, trocar point flat
 Tornillo Ø 6 mm, punta de trocar plana
 Vis Ø 6 mm, pointe trocar platte
 Vite Ø 6 mm, punta a trequarti piatta

Schanz**713.30.18**19 cm - 7¹/₂"

ORTHO PAEDICS

IMPLANTS AND INSTRUMENTS

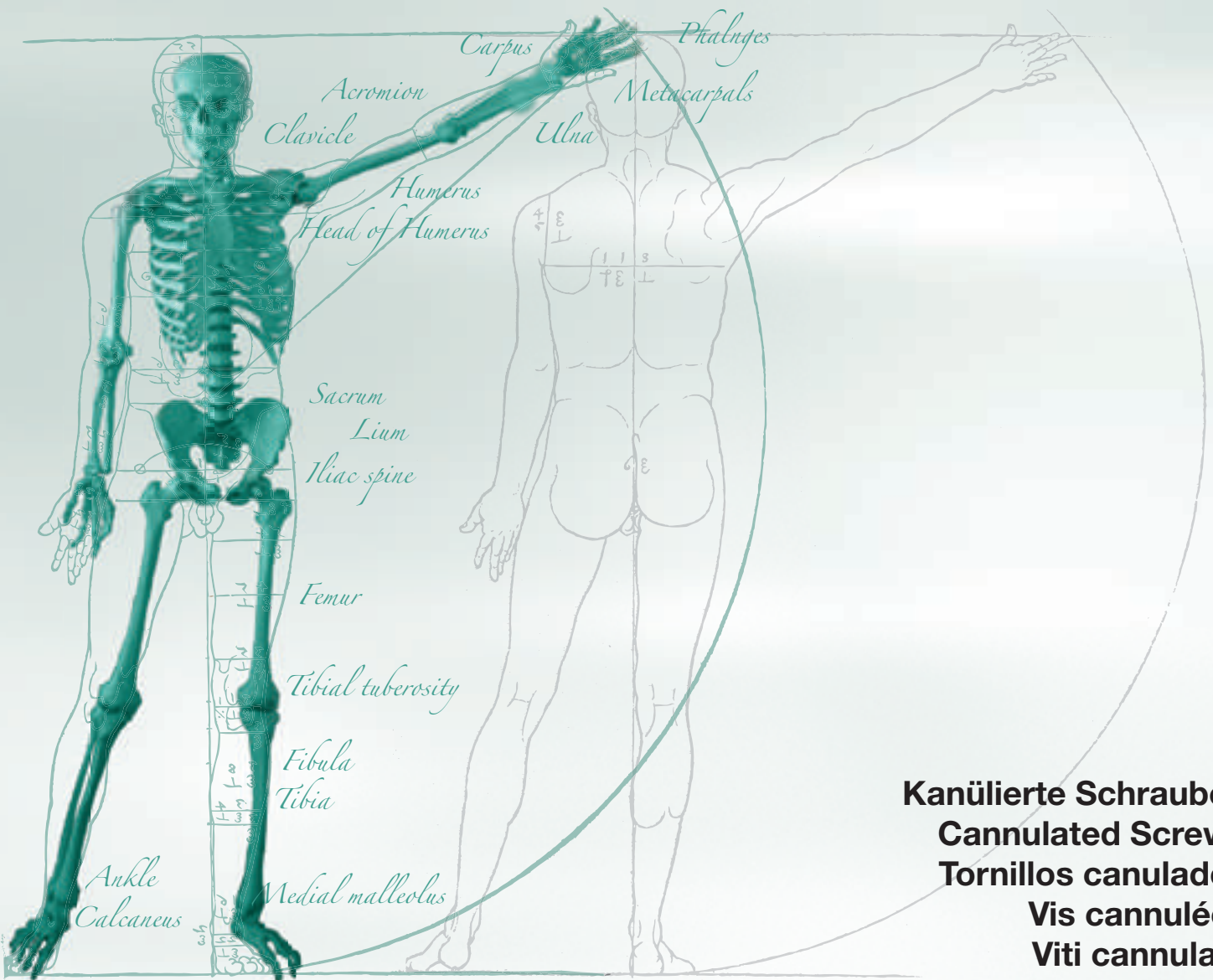

Kanülierte Schrauben
Cannulated Screws
Tornillos canulados
Vis cannulées
Viti cannulate

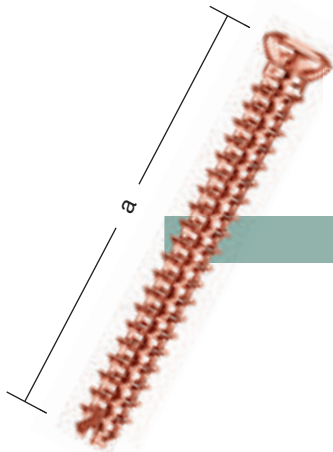

Kanülierte Schrauben 3,5 mm
Cannulated Screws 3,5 mm
Tornillos canulados 3,5 mm
Vis cannulées 3,5 mm
Viti cannulate 3,5 mm

3.5

Vollgewinde selbstschneidend
 Full thread self-tapping
 Rosca completa cortante
 Filetage complet autotarauteur
 Filetto totale autofilettante

P  5

ST

Ti

a

712.35.01	712.37.01	10 mm
712.35.02	712.37.02	12 mm
712.35.03	712.37.03	14 mm
712.35.04	712.37.04	16 mm
712.35.05	712.37.05	18 mm
712.35.06	712.37.06	20 mm
712.35.07	712.37.07	22 mm
712.35.08	712.37.08	24 mm
712.35.09	712.37.09	26 mm
712.35.10	712.37.10	28 mm
712.35.11	712.37.11	30 mm
712.35.12	712.37.12	32 mm
712.35.13	712.37.13	34 mm
712.35.14	712.37.14	36 mm
712.35.15	712.37.15	38 mm
712.35.16	712.37.16	40 mm
712.35.17	712.37.17	42 mm
712.35.18	712.37.18	44 mm
712.35.19	712.37.19	46 mm
712.35.20	712.37.20	48 mm
712.35.21	712.37.21	50 mm



3,5 mm



2,5 mm

Bohrer für Gewindeloch 2,7 mm siehe Seite 106
 Drill for threaded hole 2,7 mm see page 106
 Broca para orificio roscado 2,7 mm vea la página 106
 Foret pour trou fileté de 2,7 mm voir page 106
 Perforatore per foro filettato 2,7 mm vedi pagina 106

Bohrer für Gleitloch 3,5 mm siehe Seite 106
 Drill for sliding hole 3,5 mm see page 106
 Broca para orificio de deslizamiento 3,5 mm vea la página 106
 Foret pour trou lisse de 3,5 mm voir page 106
 Perforatore per foro di scorrimento 3,5 mm vedi pagina 106

76.10.62
 passender Kirschner Bohrdraht siehe Seite 220
 suitable Kirschner wire see page 220
 adecuado broca Kirschner vea página 220
 broches de Kirschner appropriées voir page 220
 adatto filo di Kirschner vedi pagina 220



Verpackungseinheit "X" Stück
 Packing unit "X" pieces
 Paquete de "X" unidades
 Emballage de "X" pièces
 Confezione da "X" pezzi



Stahl
 Steel
 Acero
 Acier
 Acciaio



Titan
 Titanium
 Titanio
 Titane
 Titanio



3.5

Kanülierte Schrauben 3,5 mm
Cannulated Screws 3,5 mm
Tornillos canulados 3,5 mm
Vis cannulées 3,5 mm
Viti cannulate 3,5 mm



Teilgewinde selbstschneidend
 Partial thread self-tapping
 Rosca parcial cortante
 Filetage partiel autotaraudeur
 Filetto parziale autofilettanti

P ₅	ST	Ti	a	b
	712.36.01	712.38.01	10 mm	4 mm
	712.36.02	712.38.02	12 mm	4 mm
	712.36.03	712.38.03	14 mm	5 mm
	712.36.04	712.38.04	16 mm	5 mm
	712.36.05	712.38.05	18 mm	6 mm
	712.36.06	712.38.06	20 mm	7 mm
	712.36.07	712.38.07	22 mm	7 mm
	712.36.08	712.38.08	24 mm	8 mm
	712.36.09	712.38.09	26 mm	8 mm
	712.36.10	712.38.10	28 mm	9 mm
	712.36.11	712.38.11	30 mm	10 mm
	712.36.12	712.38.12	32 mm	11 mm
	712.36.13	712.38.13	34 mm	11 mm
	712.36.14	712.38.14	36 mm	12 mm
	712.36.15	712.38.15	38 mm	12 mm
	712.36.16	712.38.16	40 mm	13 mm
	712.36.17	712.38.17	42 mm	14 mm
	712.36.18	712.38.18	44 mm	14 mm
	712.36.19	712.38.19	46 mm	15 mm
	712.36.20	712.38.20	48 mm	15 mm
	712.36.21	712.38.21	50 mm	16 mm

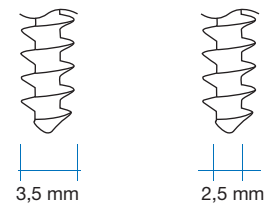
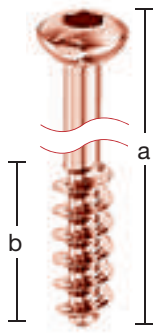

Bohrer für Gewindeloch 2,7 mm siehe Seite 106
 Drill for threaded hole 2,7 mm see page 106
 Broca para orificio roscado 2,7 mm vea la página 106
 Foret pour trou fileté de 2,7 mm voir page 106
 Perforatore per foro filettato 2,7 mm vedi pagina 106

Bohrer für Gleitloch 3,5 mm siehe Seite 106
 Drill for sliding hole 3,5 mm see page 106
 Broca para orificio de deslizamiento 3,5 mm vea la página 106
 Foret pour trou lisse de 3,5 mm voir page 106
 Perforatore per foro di scorrimento 3,5 mm vedi pagina 106

76.10.62
 passender Kirschner Bohrdraht siehe Seite 220
 suitable Kirschner wire see page 220
 adecuado broca Kirschner vea página 220
 broches de Kirschner appropriées voir page 220
 adatto filo di Kirschner vedi pagina 220

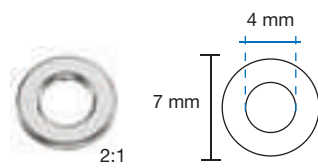

Unterlegscheibe für kanülierte Schrauben 3,5 mm
 Washer for cannulated screws 3,5 mm
 Arandela para tornillos canulados 3,5 mm
 Rondelle pour vis cannulée 3,5 mm
 Rondella per viti cannulate 3,5 mm

P ₅	710.00.00
----------------	-----------

P_X Verpackungseinheit "X" Stück
 Packing unit "X" pieces
 Paquete de "X" unidades
 Emballage de "X" pièces
 Confezione da "X" pezzi

ST Stahl
 Steel
 Acero
 Acier
 Acciaio

Ti Titan
 Titanium
 Titanio
 Titane
 Titanio

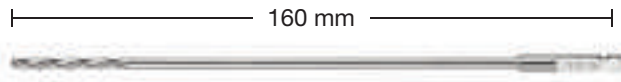

Instrumentarium für kanülierte Schrauben 3,5 mm
Instrumentation for cannulated Screws 3,5 mm
Instrumental para tornillos canulados 3,5 mm
Instruments pour vis cannulées 3,5 mm
Strumenti per viti cannulate 3,5 mm

3.5

Bohrer für Schnellkupplung, kanüliert
 Drills for quick coupling, cannulated
 Brocas para acoplamiento rápido, canuladas
 Forets pour accouplement rapide, canulés
 Perforatori per accoppiamento rapido, cannulato

		a	b
vierschneidig four-edged filos cuatro quatre pans quattro tagli	712.35.50	Ø 1,35 mm	Ø 2,7 mm
	712.35.51	Ø 1,35 mm	Ø 3,5 mm

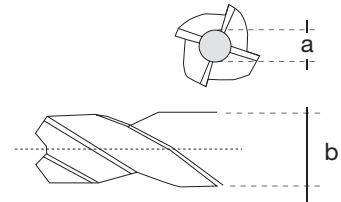

Kopfraumfräser für Schnellkupplung, kanüliert
 Countersink for quick coupling, cannulated
 Fresa para acoplamiento rápido, canulada
 Fraise pour accouplement rapide, canulée
 Fresa per accoppiamento rapido, cannulata

		a	b
	712.35.52	Ø 1,35 mm	Ø 5,0 mm

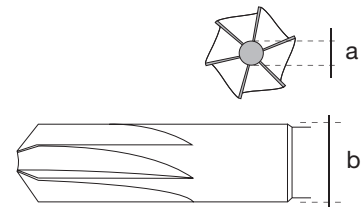

Handgriff
 Handle
 Mango
 Manche
 Manico

mit Schnellkupplung
 with quick coupling
 con acoplamiento rápido
 avec accouplement rapide
 con accoppiamento rapido

709.30.10

Kunststoffgriff (autoklavierbar bis 134 °C bei 3 bar)
 Plastic handle (autoclavable up to 134 °C at 3 bar)
 Mango de plástico (autoclavable hasta 134 °C bajo presión de 3 bar)
 Manche en plastique (autoclavable à 134 °C sous pression de 3 bars)
 Manico di plastica (autoclavabile fino a 134 °C sotto pressione di 3 bar)



3.5

Instrumentarium für kanülierte Schrauben 3,5 mm
Instrumentation for cannulated Screws 3,5 mm
Instrumental para tornillos canulados 3,5 mm
Instruments pour vis cannulées 3,5 mm
Strumenti per viti cannulate 3,5 mm



Doppelbohrbuchse
 Double drill sleeve
 Casquillo de taladrar doble
 Double douille de forage
 Bussola di foratura doppia



710.30.09	Ø 3,5 mm	Ø 2,5 mm
------------------	----------	----------



Doppelbohrbuchse
 Double drill sleeve
 Casquillo de taladrar doble
 Double douille de forage
 Bussola di foratura doppia



712.35.53	Ø 2,7 mm	Ø 1,25 mm
------------------	----------	-----------

2,5 mm



Schraubendreher Sechskant
 Screwdriver hexagonal
 Atornillador hexagonal
 Tournevis hexagonal
 Cacciavite esagonale

kanüliert 2,5 mm
 cannulated 2,5 mm
 canulada 2,5 mm
 cannulée 2,5 mm
 cannulata 2,5 mm

	712.35.54
---	------------------



Kunststoffgriff (autoklavierbar bis 134 °C bei 3 bar)
 Plastic handle (autoclavable up to 134 °C at 3 bar)
 Mango de plástico (autoclavable hasta 134 °C bajo presión de 3 bar)
 Manche en plastique (autoclavable à 134 °C sous pression de 3 bars)
 Manico di plastica (autoclavabile fino a 134 °C sotto pressione di 3 bar)



für Gewindeschneider
 for taps
 para roscadores
 pour tarauds
 per filettatori



für Bohrer
 for drills
 para brocas
 pour forets
 per perforatori



Instrumentarium für kanülierte Schrauben 3,5 mm
Instrumentation for cannulated Screws 3,5 mm
Instrumental para tornillos canulados 3,5 mm
Instruments pour vis cannulées 3,5 mm
Strumenti per viti cannulate 3,5 mm

3.5

1:1

Haltehülse für Schrauben
Holding sleeve for screws
Vaina para tornillos
Douille pour tenir les vis
Boccola per viti

für Schrauben Ø 3,5 mm
for screws Ø 3,5 mm
para tornillos Ø 3,5 mm
pour vis Ø 3,5 mm
per viti Ø 3,5 mm

709.30.19

1:1

Schraubenhaltepinzette
Screw holding forceps
Pinza para agarrar tornillos
Pince pour tenir les vis
Pinza per tenere viti

709.30.40



4.5

Kanülierte Schrauben 4,5 mm
Cannulated Screws 4,5 mm
Tornillos canulados 4,5 mm
Vis cannulées 4,5 mm
Viti cannulate 4,5 mm

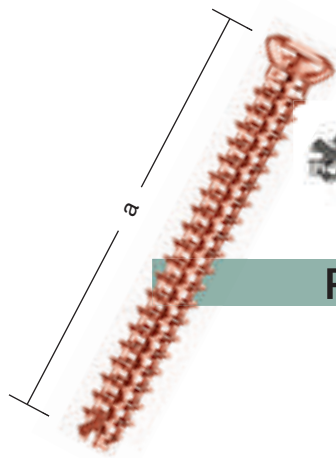

Vollgewinde selbstschneidend
 Full thread self-tapping
 Rosca completa cortante
 Filetage complet autotarauteur
 Filetto completo autofilettante

P₅

ST

Ti

a

712.45.01	712.47.01	20 mm
712.45.02	712.47.02	22 mm
712.45.03	712.47.03	24 mm
712.45.04	712.47.04	26 mm
712.45.05	712.47.05	28 mm
712.45.06	712.47.06	30 mm
712.45.07	712.47.07	32 mm
712.45.08	712.47.08	34 mm
712.45.09	712.47.09	36 mm
712.45.10	712.47.10	38 mm
712.45.11	712.47.11	40 mm
712.45.12	712.47.12	42 mm
712.45.13	712.47.13	44 mm
712.45.14	712.47.14	46 mm
712.45.15	712.47.15	48 mm
712.45.16	712.47.16	50 mm
712.45.17	712.47.17	52 mm
712.45.18	712.47.18	54 mm
712.45.19	712.47.19	56 mm
712.45.20	712.47.20	60 mm
712.45.21	712.47.21	64 mm
712.45.22	712.47.22	68 mm
712.45.23	712.47.23	72 mm



4,5 mm



3,2 mm

Bohrer für Gewindeloch 3,2 mm siehe Seite 111
 Drill for threaded hole 3,2 mm see page 111
 Broca para orificio roscado 3,2 mm vea la página 111
 Foret pour trou fileté de 3,2 mm voir page 111
 Perforatore per foro filettato 3,2 mm vedi pagina 111

Bohrer für Gleitloch 4,5 mm siehe Seite 111
 Drill for sliding hole 4,5 mm see page 111
 Broca para orificio de deslizamiento 4,5 mm vea la página 111
 Foret pour trou lisse de 4,5 mm voir page 111
 Perforatore per foro di scorrimento 4,5 mm vedi pagina 111

76.10.66
 passender Kirschner Bohrdraht siehe Seite 220
 suitable Kirschner wire see page 220
 adecuado broca Kirschner vea página 220
 broches de Kirschner appropriées voir page 220
 adatto filo di Kirschner vedi pagina 220

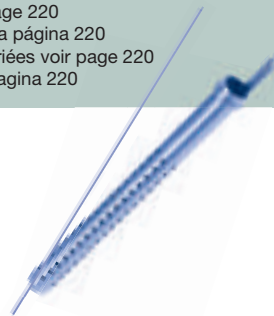

Verpackungseinheit "X" Stück
 Packing unit "X" pieces
 Paquete de "X" unidades
 Emballage de "X" pièces
 Confezione da "X" pezzi



Stahl
 Steel
 Acero
 Acier
 Acciaio



Titan
 Titanium
 Titanio
 Titane
 Titanio



Kanülierte Schrauben 4,5 mm
Cannulated Screws 4,5 mm
Tornillos canulados 4,5 mm
Vis cannulées 4,5 mm
Viti cannulate 4,5 mm

4.5

Teilgewinde selbstschneidend
 Partial thread self-tapping
 Rosca parcial cortante
 Filetage partiel autotaraudeur
 Filetto parziale autofilettante

P ₅	ST	Ti	a	b	
	712.46.01	712.48.01	20 mm	7 mm	
	712.46.02	712.48.02	22 mm	7 mm	
	712.46.03	712.48.03	24 mm	8 mm	
	712.46.04	712.48.04	26 mm	9 mm	
	712.46.05	712.48.05	28 mm	9 mm	
	712.46.06	712.48.06	30 mm	10 mm	
	712.46.07	712.48.07	32 mm	11 mm	
	712.46.08	712.48.08	34 mm	11 mm	
	712.46.09	712.48.09	36 mm	12 mm	
	712.46.10	712.48.10	38 mm	13 mm	
	712.46.11	712.48.11	40 mm	13 mm	
	712.46.12	712.48.12	42 mm	14 mm	
	712.46.13	712.48.13	44 mm	15 mm	
	712.46.14	712.48.14	46 mm	15 mm	
	712.46.15	712.48.15	48 mm	16 mm	
	712.46.16	712.48.16	50 mm	16 mm	
	712.46.17	712.48.17	52 mm	17 mm	
	712.46.18	712.48.18	54 mm	18 mm	
	712.46.19	712.48.19	56 mm	19 mm	
	712.46.20	712.48.20	60 mm	20 mm	
	712.46.21	712.48.21	64 mm	21 mm	
	712.46.22	712.48.22	68 mm	23 mm	
	712.46.23	712.48.23	72 mm	24 mm	

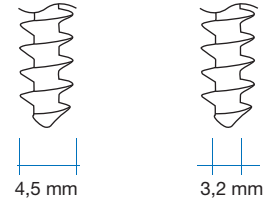

Bohrer für Gewindeloch 3,2 mm siehe Seite 111
 Drill for threaded hole 3,2 mm see page 111
 Broca para orificio roscado 3,2 mm vea la página 111
 Foret pour trou fileté de 3,2 mm voir page 111
 Perforatore per foro filettato 3,2 mm vedi pagina 111

Bohrer für Gleitloch 4,5 mm siehe Seite 111
 Drill for sliding hole 4,5 mm see page 111
 Broca para orificio de deslizamiento 4,5 mm vea la página 111
 Foret pour trou lisse de 4,5 mm voir page 111
 Perforatore per foro di scorrimento 4,5 mm vedi pagina 111

76.10.66
 passender Kirschner Bohrdraht siehe Seite 226
 suitable Kirschner wire see page 226
 adecuado broca Kirschner vea página 226
 broches de Kirschner appropriées voir page 226
 adatto filo di Kirschner vedi pagina 226

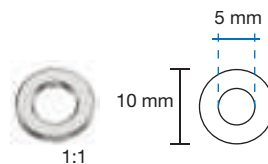

Unterlegscheibe für kanülierte Schrauben 4,5 mm
 Washer for cannulated screws 4,5 mm
 Arandela para tornillos canulados 4,5 mm
 Rondelle pour vis cannulée 4,5 mm
 Rondella per viti cannulate 4,5 mm

P₅**711.00.00**

Verpackungseinheit "X" Stück
 Packing unit "X" pieces
 Paquete de "X" unidades
 Emballage de "X" pièces
 Confezione da "X" pezzi



Stahl
 Steel
 Acero
 Acier
 Acciaio



Titan
 Titanium
 Titanio
 Titane
 Titanio



4.5

Instrumentarium für kanülierte Schrauben 4,5 mm
Instrumentation for cannulated Screws 4,5 mm
Instrumental para tornillos canulados 4,5 mm
Instruments pour vis cannulées 4,5 mm
Strumenti per viti cannulate 4,5 mm

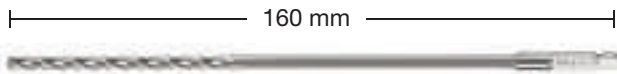

Bohrer für Schnellkupplung, kanüliert
 Drills for quick coupling, cannulated
 Brocas para acoplamiento rápido, canulada
 Forets pour accouplement rapide, canulés
 Perforatori per accoppiamento rapido, cannulato

	a	b
vierschneidig four-edged filos cuatro quatre pans quattro tagli	712.45.50 Ø 1,75 mm	Ø 3,2 mm
	712.45.51 Ø 1,75 mm	Ø 4,5 mm

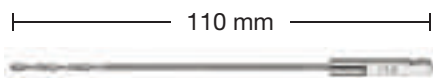
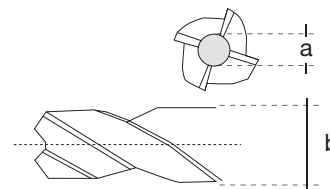

Bohrer für Schnellkupplung
 Drill for quick coupling
 Broca para acoplamiento rápido
 Foret pour accouplement rapide
 Perforatore per accoppiamento rapido

	Ø
709.30.22	1,5 mm

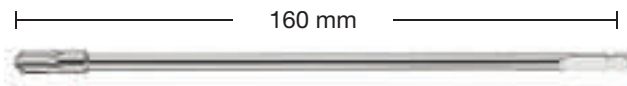

Kopfraumfräser für Schnellkupplung, kanüliert
 Countersink for quick coupling, cannulated
 Fresa para acoplamiento rápido, canulada
 Fraise pour accouplement rapide, canulée
 Fresa per accoppiamento rapido, cannulata

	a	b
712.45.53	Ø 1,8 mm	Ø 6,5 mm

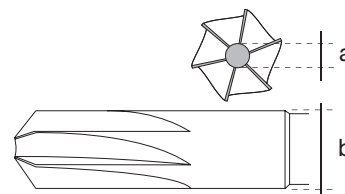

T-Griff, klein, mit Schnellkupplung
 T-handle, small, with quick coupling
 Mango en T, pequeño, con acoplamiento rápido
 Manche en T, petit, avec accouplement rapide
 Manico a T, piccolo, con accoppiamento rapido

711.30.12



Instrumentarium für kanülierte Schrauben 4,5 mm
Instrumentation for cannulated Screws 4,5 mm
Instrumental para tornillos canulados 4,5 mm
Instruments pour vis cannulées 4,5 mm
Strumenti per viti cannulate 4,5 mm

4.5

Doppelbohrbuchse
 Double drill sleeve
 Casquillo de taladrar doble
 Double douille de forage
 Bussola di foratura doppia

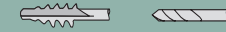
711.30.08

Ø 4,5 mm

Ø 3,2 mm

3,5 mm

 2,0 mm



Schraubendreher Sechskant
 Screwdriver hexagonal
 Atornillador hexagonal
 Tournevis hexagonal
 Cacciavite esagonale

kanüliert 2,0 mm
 cannulated 2,0 mm
 canulada 2,0 mm
 cannulée 2,0 mm
 cannulata 2,0 mm

712.45.54

1:1

Haltehülse für Schrauben
 Holding sleeve for screws
 Vaina para tornillos
 Douille pour tenir les vis
 Boccola per viti

für Schrauben Ø 4,5 mm
 for screws Ø 4,5 mm
 para tornillos Ø 4,5 mm
 pour vis Ø 4,5 mm
 per viti Ø 4,5 mm

712.45.55

1:1

Schraubenhaltepinzette
 Screw holding forceps
 Pinza para agarrar tornillos
 Pince pour tenir les vis
 Pinza per tenere viti

709.30.40

für Gewindeschneider
 for taps
 para roscadores
 pour tarauds
 per filettatori



für Bohrer
 for drills
 para brocas
 pour forets
 per perforatori



7.0

Kanülierte Schrauben 7,0 mm
Cannulated Screws 7,0 mm
Tornillos canulados 7,0 mm
Vis cannulées 7,0 mm
Viti cannulate 7,0 mm



Teilgewinde selbstschneidend
 Partial thread self-tapping
 Rosca parcial cortante
 Filetage partiel autotaraudeur
 Filetto parziale autofilettante

P ₅	ST	Ti	a
	712.70.01	712.72.01	30 mm
	712.70.02	712.72.02	35 mm
	712.70.03	712.72.03	40 mm
	712.70.04	712.72.04	45 mm
	712.70.05	712.72.05	50 mm
	712.70.06	712.72.06	55 mm
	712.70.07	712.72.07	60 mm
	712.70.08	712.72.08	65 mm
	712.70.09	712.72.09	70 mm
	712.70.10	712.72.10	75 mm
	712.70.11	712.72.11	80 mm
	712.70.12	712.72.12	85 mm
	712.70.13	712.72.13	90 mm
	712.70.14	712.72.14	95 mm
	712.70.15	712.72.15	100 mm
	712.70.16	712.72.16	105 mm
	712.70.17	712.72.17	110 mm
	712.70.18	712.72.18	115 mm
	712.70.19	712.72.19	120 mm
	712.70.20	712.72.20	125 mm
	712.70.21	712.72.21	130 mm

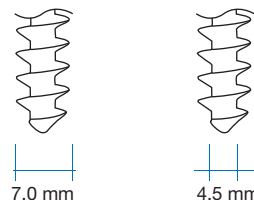
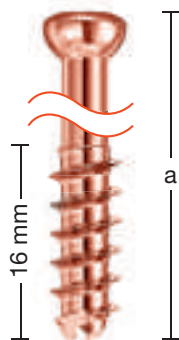

Bohrer für Gewindeloch 4,5 mm siehe Seite 115
 Drill for threaded hole 4,5 mm see page 115
 Broca para orificio roscado 4,5 mm vea la página 115
 Foret pour trou fileté de 4,5 mm voir page 115
 Perforatore per foro filettato 4,5 mm vedi pagina 115

76.11.70
 passender Kirschner Bohrdraht siehe Seite 220
 suitable Kirschner wire see page 220
 adecuado broca Kirschner vea página 220
 broches de Kirschner appropriées voir page 220
 adatto filo di Kirschner vedi pagina 220

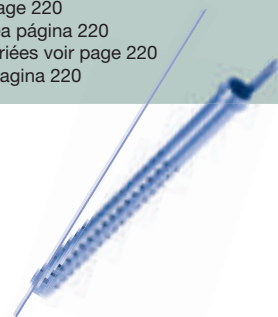

P_X
 Verpackungseinheit "X" Stück
 Packing unit "X" pieces
 Paquete de "X" unidades
 Emballage de "X" pièces
 Confezione da "X" pezzi

ST
 Stahl
 Steel
 Acero
 Acier
 Acciaio

Ti
 Titan
 Titanium
 Titanio
 Titane
 Titanio



Kanülierte Schrauben 7,0 mm
Cannulated Screws 7,0 mm
Tornillos canulados 7,0 mm
Vis cannulées 7,0 mm
Viti cannulate 7,0 mm

7.0

Teilgewinde selbstschneidend
 Partial thread self-tapping
 Rosca parcial cortante
 Filetage partiel autotaraudeur
 Filetto parziale autofilettante

P ₅	ST	Ti	a
	712.71.01	712.73.01	
712.71.02	712.73.02	50 mm	
712.71.03	712.73.03	55 mm	
712.71.04	712.73.04	60 mm	
712.71.05	712.73.05	65 mm	
712.71.06	712.73.06	70 mm	
712.71.07	712.73.07	75 mm	
712.71.08	712.73.08	80 mm	
712.71.09	712.73.09	85 mm	
712.71.10	712.73.10	90 mm	
712.71.11	712.73.11	95 mm	
712.71.12	712.73.12	100 mm	
712.71.13	712.73.13	105 mm	
712.71.14	712.73.14	110 mm	
712.71.15	712.73.15	115 mm	
712.71.16	712.73.16	120 mm	
712.71.17	712.73.17	125 mm	
712.71.18	712.73.18	130 mm	

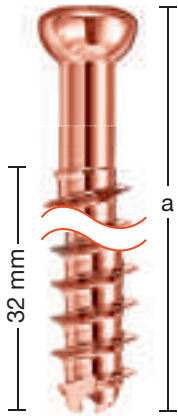

7,0 mm



4,5 mm

Bohrer für Gewindeloch 4,5 mm siehe Seite 115
 Drill for threaded hole 4,5 mm see page 115
 Broca para orificio roscado 4,5 mm vea la página 115
 Foret pour trou fileté de 4,5 mm voir page 115
 Perforatore per foro filettato 4,5 mm vedi pagina 115

76.11.70
 passender Kirschner Bohrdrat siehe Seite 220
 suitable Kirschner wire see page 220
 adecuado broca Kirschner vea página 220
 broches de Kirschner appropriées voir page 220
 adatto filo di Kirschner vedi pagina 220

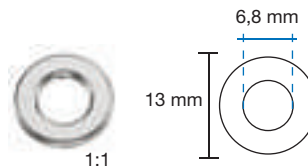

Unterlegscheibe für kanülierte Schrauben 7,0 mm
 Washer for cannulated screws 7,0 mm
 Arandela para tornillos canulados 7,0 mm
 Rondelle pour vis cannulée 7,0 mm
 Rondella per viti cannulate 7,0 mm

P ₅	711.00.01



Verpackungseinheit "X" Stück
 Packing unit "X" pieces
 Paquete de "X" unidades
 Emballage de "X" pièces
 Confezione da "X" pezzi



Stahl
 Steel
 Acero
 Acier
 Acciaio



Titan
 Titanium
 Titanio
 Titane
 Titanio



7.0

Instrumentarium für kanülierte Schrauben 7,0 mm
Instrumentation for cannulated Screws 7,0 mm
Instrumental para tornillos canulados 7,0 mm
Instruments pour vis cannulées 7,0 mm
Strumenti per viti cannulate 7,0 mm



Bohrer für Schnellkupplung
 Drill for quick coupling
 Broca para acoplamiento rápido
 Foret pour accouplement rapide
 Perforatore per accoppiamento rapido

	Ø
709.30.23	2,0 mm

kalibriert
 calibrated
 calibrado
 calibré
 calibrato

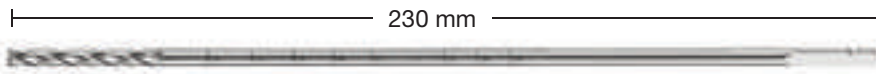

Bohrer für Dreibackenspannfutter, kanüliert
 Drill for three-jaw chuck, cannulated
 Broca para plato de tres mordazas, canulada
 Foret pour mandrin à trois mâchoires, cannulés
 Perforatore per mandrino a tre ganasce, cannulati

	a	b
712.75.50	Ø 2,1 mm	Ø 4,5 mm

vierschneidig
 four-edged
 filos cuatro
 quatre pans
 quattro tagli

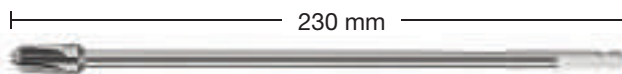
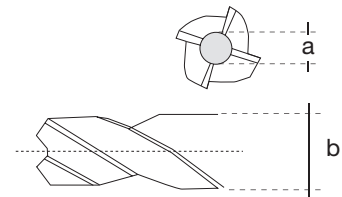

Kopfraumfräser für Schnellkupplung, kanüliert
 Countersink for quick coupling, cannulated
 Fresa para acoplamiento rápido, canulada
 Fraise pour accouplement rapide, cannulée
 Fresa per accoppiamento rapido, cannulata

	a	b
712.75.51	Ø 2,1 mm	Ø 8,0 mm

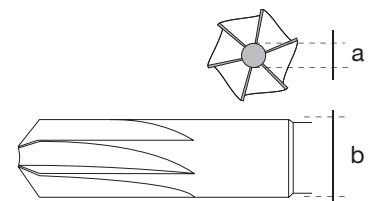



Instrumentarium für kanülierte Schrauben 7,0 mm
Instrumentation for cannulated Screws 7,0 mm
Instrumental para tornillos canulados 7,0 mm
Instruments pour vis cannulées 7,0 mm
Strumenti per viti cannulate 7,0 mm

7.0

Doppelbohrbuchse
 Double drill sleeve
 Casquillo de taladrar doble
 Double douille de forage
 Bussola di foratura doppia

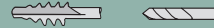

711.30.08	Ø 4,5 mm	Ø 3,2 mm
------------------	----------	----------

3,5 mm

 2,1 mm



Schraubendreher Sechskant
 Screwdriver hexagonal
 Atornillador hexagonal
 Tournevis hexagonal
 Cacciavite esagonale

kanüliert 2,1 mm
 cannulated 2,1 mm
 canulado 2,1 mm
 cannulée 2,1 mm
 cannulato 2,1 mm

	712.75.54	
--	------------------	--



Haltehülse für Schrauben
 Holding sleeve for screws
 Vaina para tornillos
 Douille pour tenir les vis
 Boccola per viti

für Schrauben Ø 4,5 / 6,5 / 7,0 mm
 for screws Ø 4,5 / 6,5 / 7,0 mm
 para tornillos Ø 4,5 / 6,5 / 7,0 mm
 pour vis Ø 4,5 / 6,5 / 7,0 mm
 per viti Ø 4,5 / 6,5 / 7,0 mm

711.30.17	
------------------	--



Kunststoffgriff (autoklavierbar bis 134 °C bei 3 bar)
 Plastic handle (autoclavable up to 134 °C at 3 bar)
 Mango de plástico (autoclavable hasta 134 °C bajo presión de 3 bar)
 Manche en plastique (autoclavable à 134 °C sous pression de 3 bars)
 Manico di plastica (autoclavabile fino a 134 °C sotto pressione di 3 bar)



für Gewindeschneider
 for taps
 para roscadores
 pour tarauds
 per filettatori



für Bohrer
 for drills
 para brocas
 pour forets
 per perforatori

ORTHO PAEDICS

IMPLANTS AND INSTRUMENTS

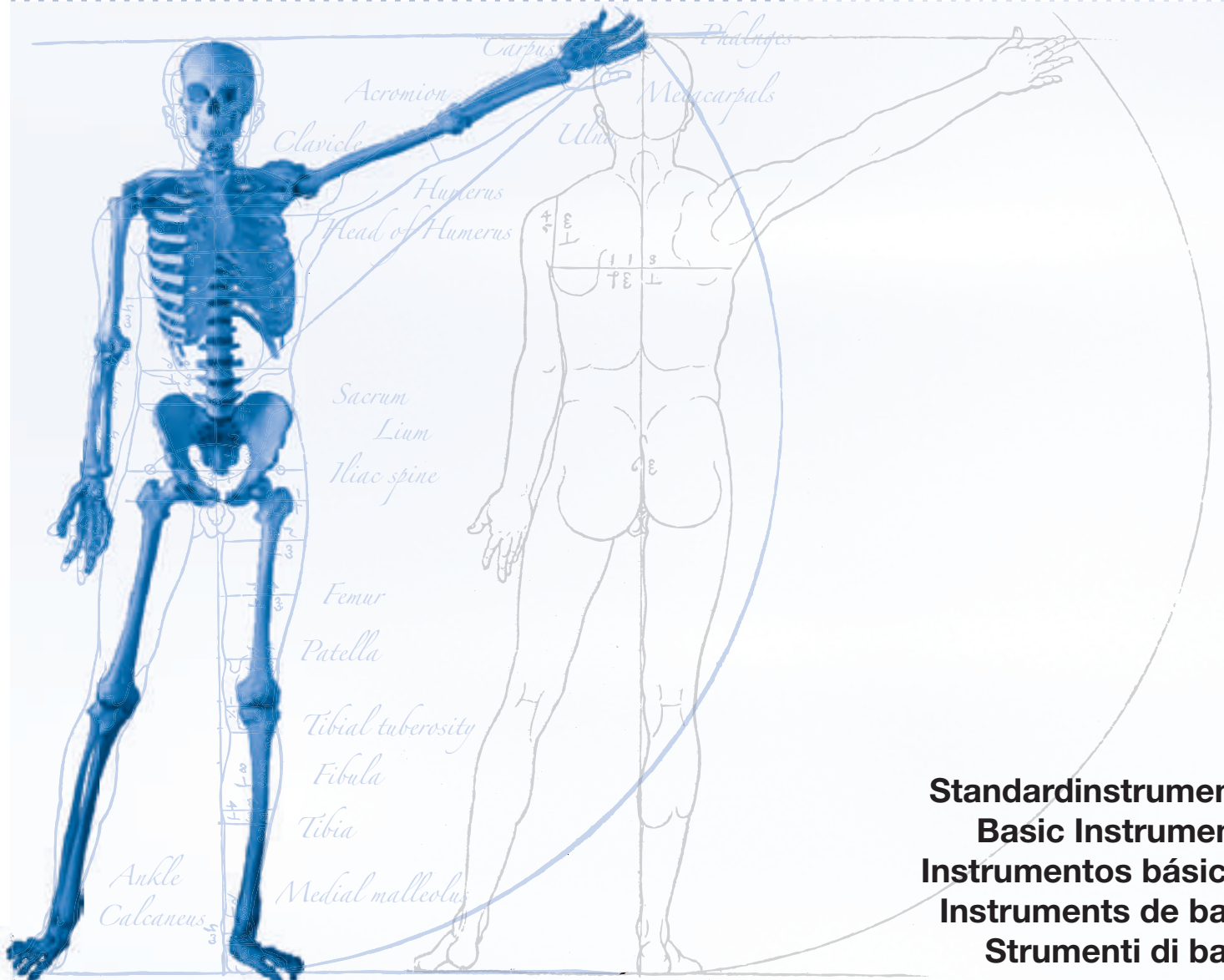

Standardinstrumente
Basic Instruments
Instrumentos básicos
Instruments de base
Strumenti di base



Knochenfeilen
Bone Files
Limas para huesos
Limes à os
Lime per ossa

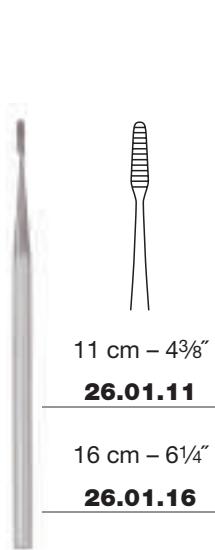

11 cm - 4³/₈"

26.01.11

16 cm - 6¹/₄"

26.01.16

Black

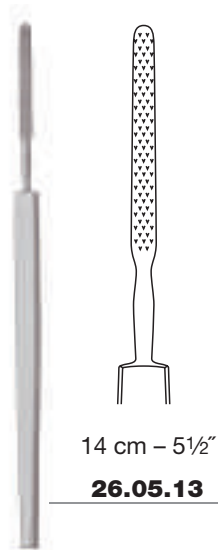

14 cm - 5¹/₂"

26.05.13

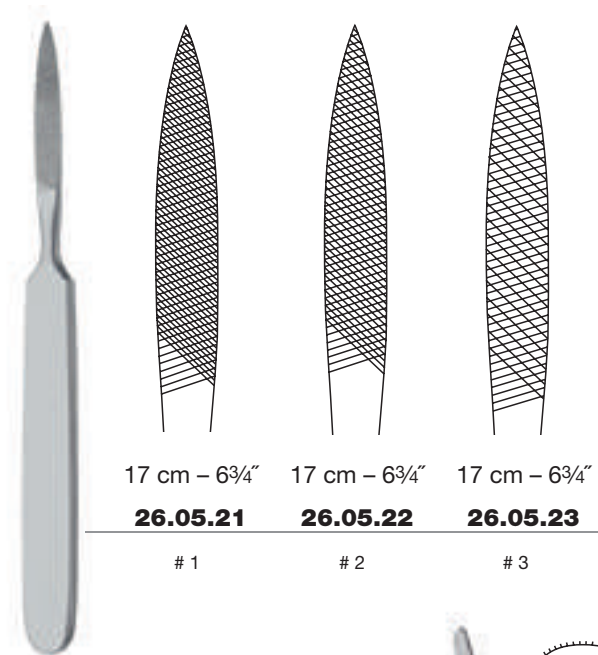

17 cm - 6³/₄"

26.05.21

1

17 cm - 6³/₄"

26.05.22

2

17 cm - 6³/₄"

26.05.23

3

Joseph

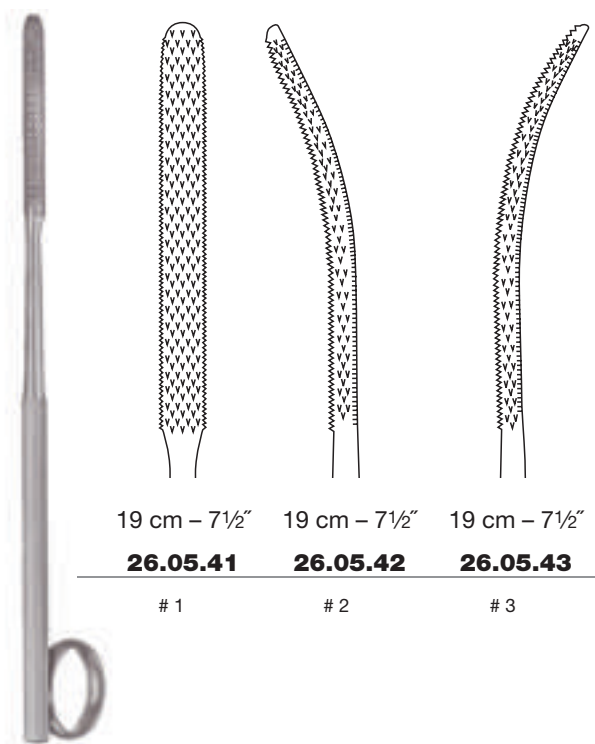
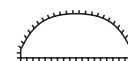

19 cm - 7¹/₂"

26.05.41

1

19 cm - 7¹/₂"

26.05.42

2

19 cm - 7¹/₂"

26.05.43

3

Gallaher



27 cm - 10³/₄"

26.15.01

Putti



30 cm - 11³/₄"

26.15.02

Putti



Knochenfeilen
Bone Files
Limas para huesos
Limes à os
Lime per ossa



Miller

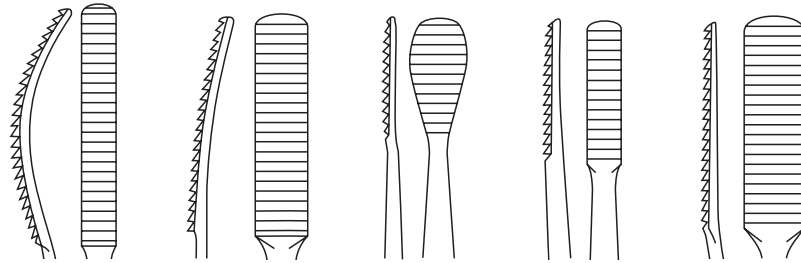

18 cm – 7 1/8" 18 cm – 7 1/8" 18 cm – 7 1/8" 18 cm – 7 1/8" 18 cm – 7 1/8"
26.10.10 **26.10.11** **26.10.12** **26.10.13** **26.10.14**

10 # 11 # 12 # 13 # 14

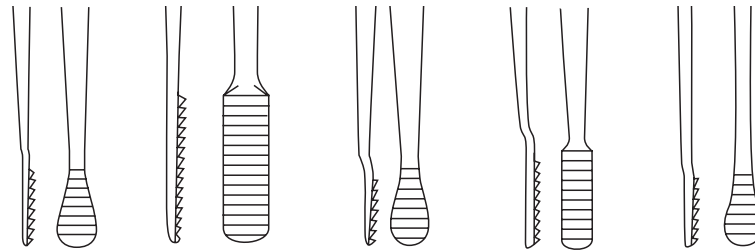

Miller

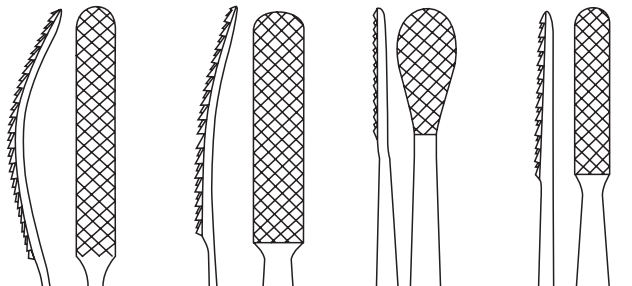

18 cm – 7 1/8" 18 cm – 7 1/8" 18 cm – 7 1/8" 18 cm – 7 1/8"
26.10.20 **26.10.21** **26.10.22** **26.10.23**

10C # 11C # 12C # 13C

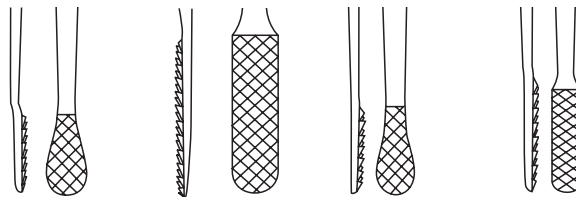



Knochenfeilen
Bone Files
Limas para huesos
Limes à os
Lime per ossa



22 cm - 8³/₄"

26.14.22

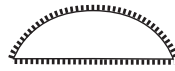

28 cm - 11"

26.14.28

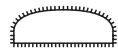

24 cm - 9¹/₂"

26.14.50



**Elevatori
Elevators
Elevadores
Élévateurs
Elevatori**

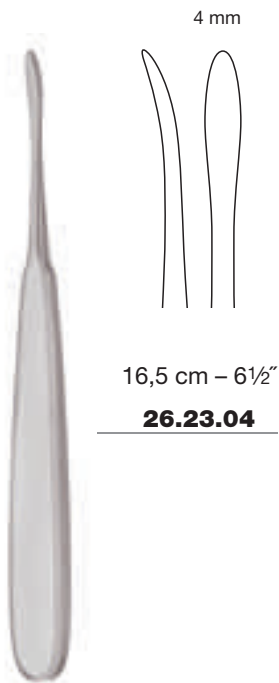

4 mm

16,5 cm – 6½"

26.23.04

Sebileau

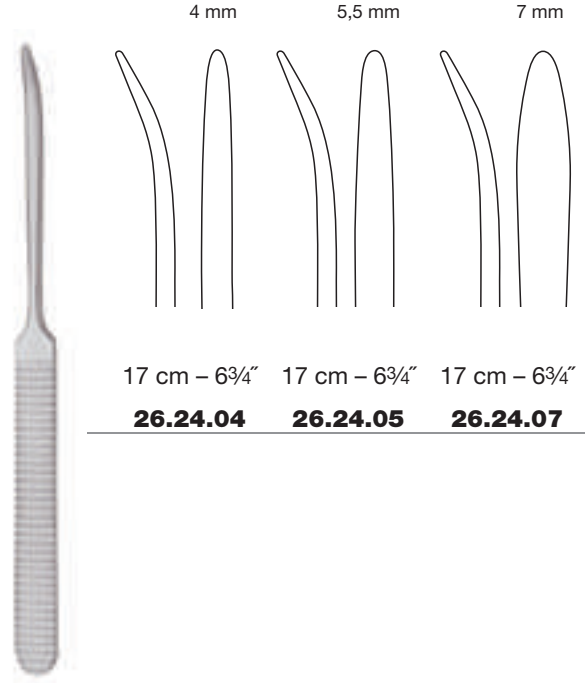

4 mm

5,5 mm

7 mm

17 cm – 6¾"

17 cm – 6¾"

17 cm – 6¾"

26.24.04

26.24.05

26.24.07

Williger

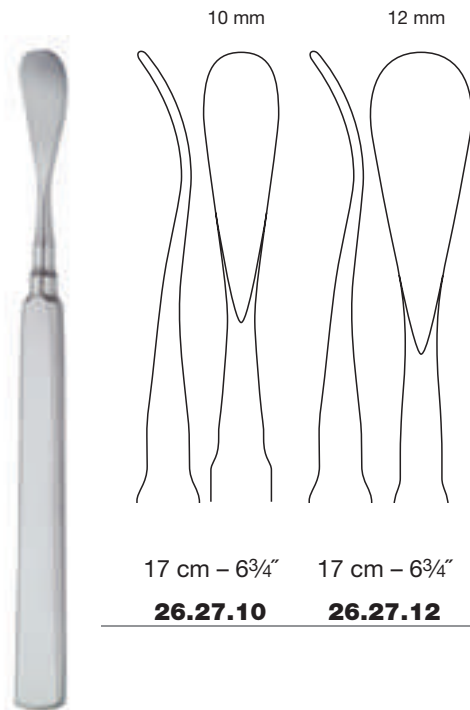

10 mm

12 mm

17 cm – 6¾"

17 cm – 6¾"

26.27.10

26.27.12

Henahan

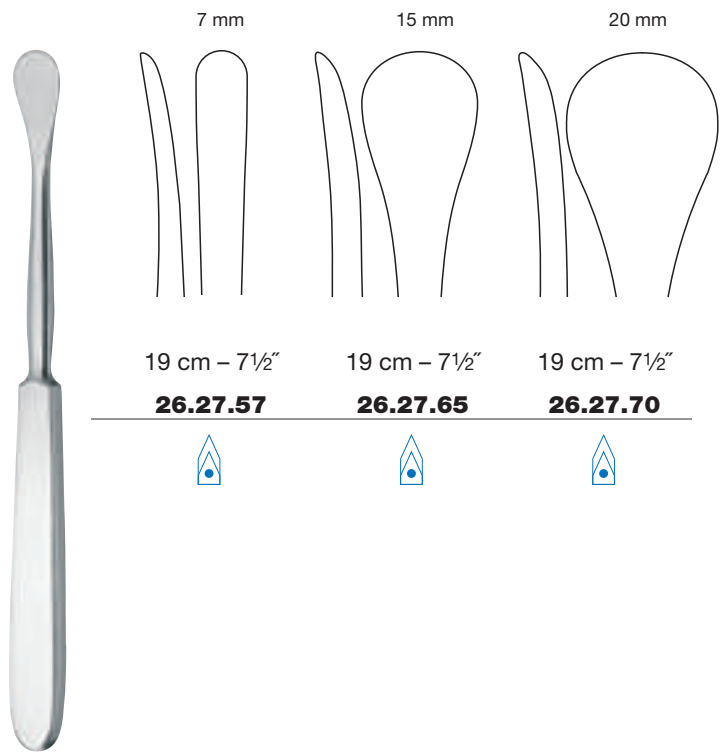

7 mm

15 mm

20 mm

19 cm – 7½"

19 cm – 7½"

19 cm – 7½"

26.27.57

26.27.65

26.27.70



Hoen



halbscharf
semi sharp
semi cortante
semi tranchant
semitagliente



Elevatorien
Elevators
Elevadores
Elévateurs
Elevatori

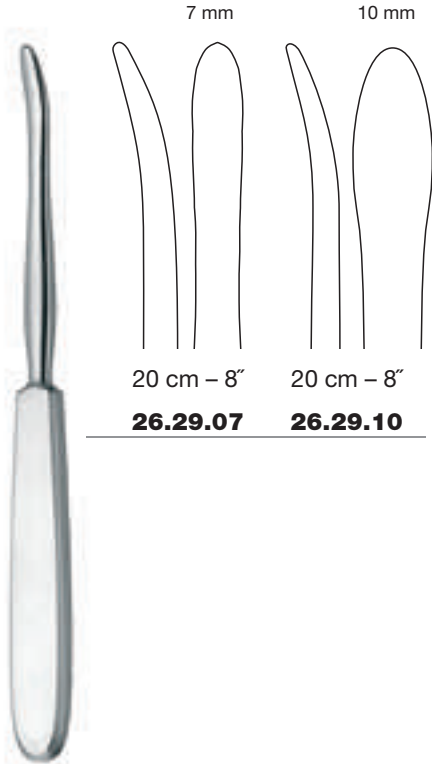

Langenbeck

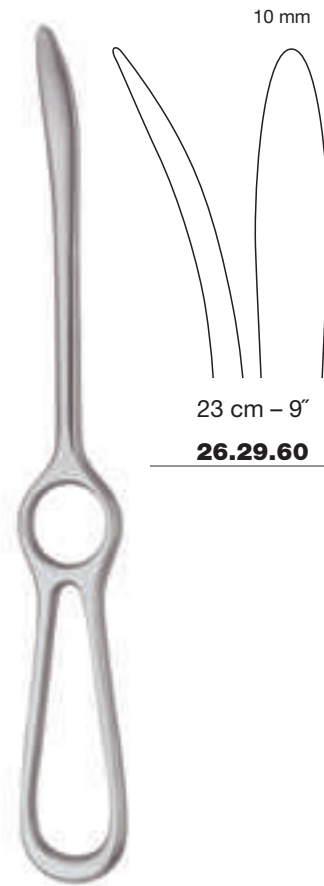

Langenbeck

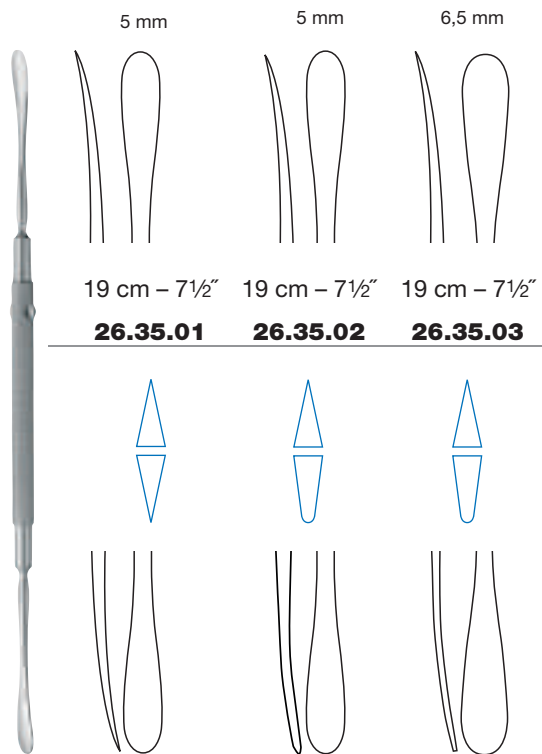

Freer

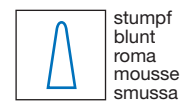



**Elevatoren
Elevators
Elevadores
Élévateurs
Elevatori**

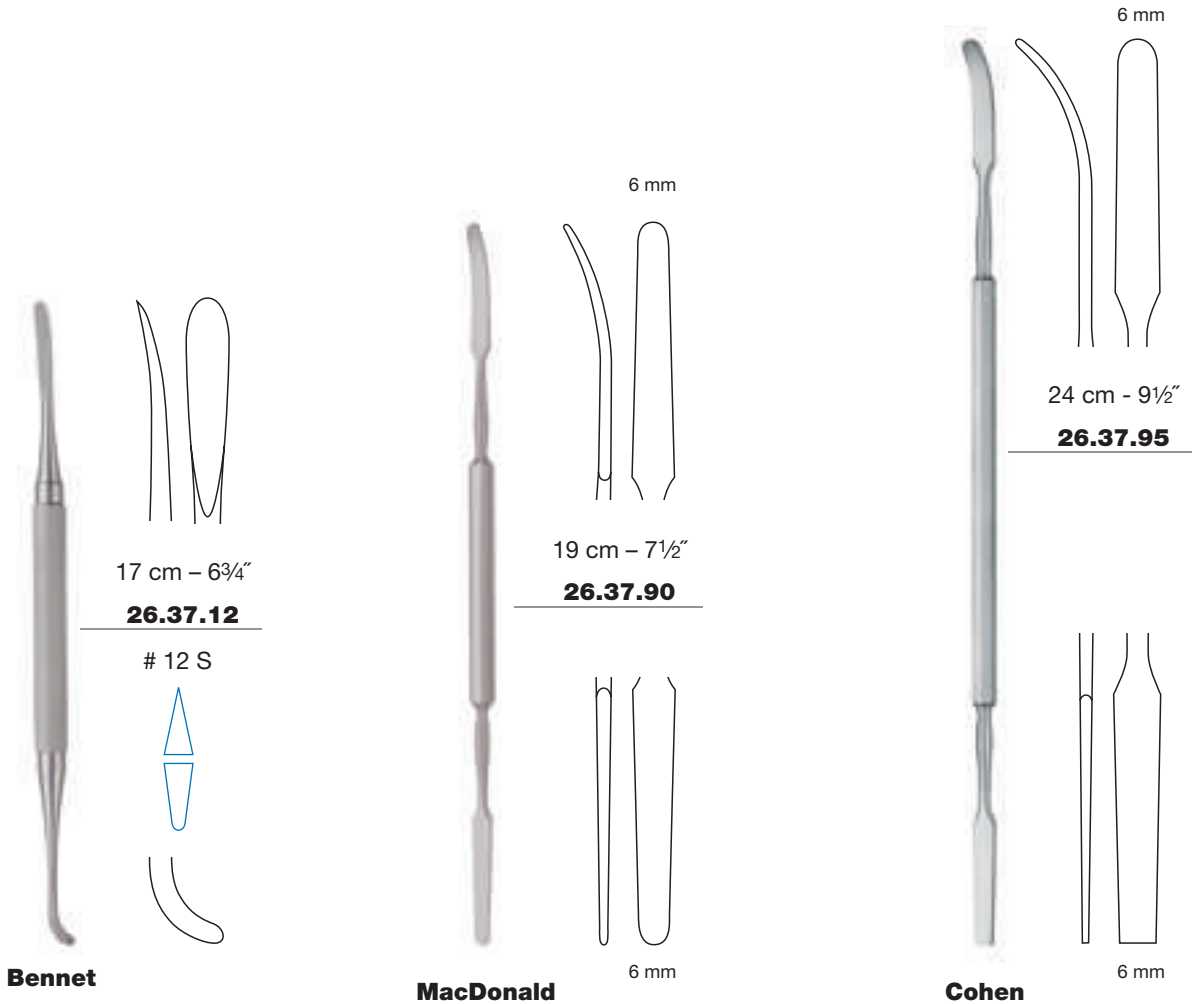

 scharf
sharp
cortante
tranchant
tagliente

 stumpf
blunt
roma
mousse
smussa



Raspatorien
Raspatories
Legras
Rugines
Periostotomi



Molt

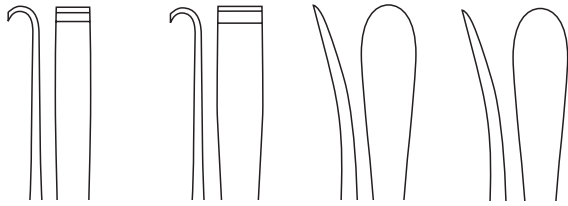

18 cm – 7 1/8" 18 cm – 7 1/8" 18 cm – 7 1/8" 18 cm – 7 1/8"
26.37.01 **26.37.02** **26.37.03** **26.37.07**

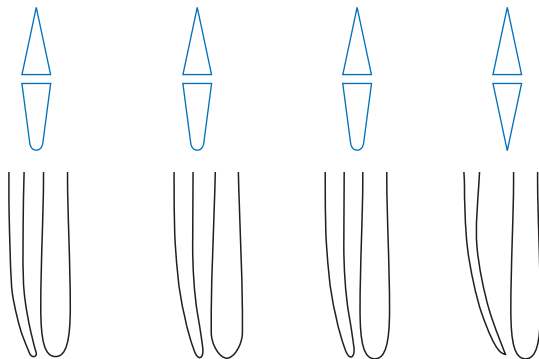

Mead



16,5 cm – 6 1/2"
26.37.10

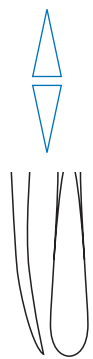

König

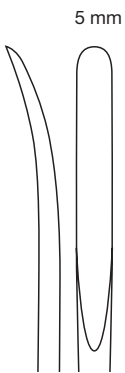

5 mm
15 cm – 6"
26.40.06



Williger

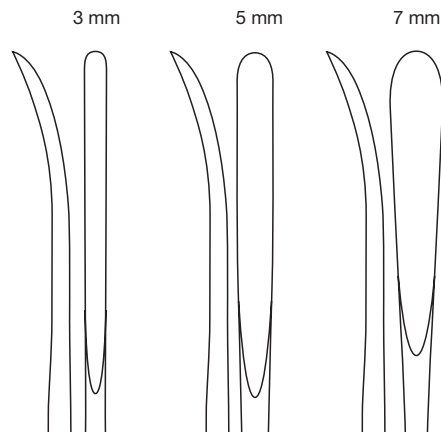

3 mm 5 mm 7 mm
16 cm – 6 1/4" 16 cm – 6 1/4" 16 cm – 6 1/4"
26.42.03 **26.42.05** **26.42.07**



scharf
sharp
cortante
tranchant
tagliante



stumpf
blunt
roma
mousse
smussa



Raspatorien
Raspatories
Legras
Rugines
Periostotomi

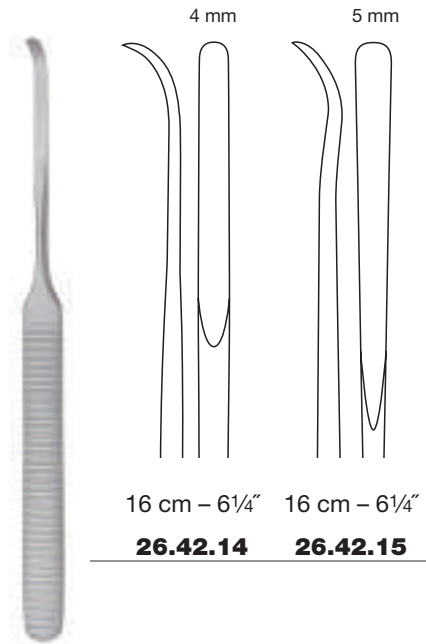

4 mm 5 mm

16 cm – 6¼" 16 cm – 6¼"

26.42.14 **26.42.15**

Kahre-Williger

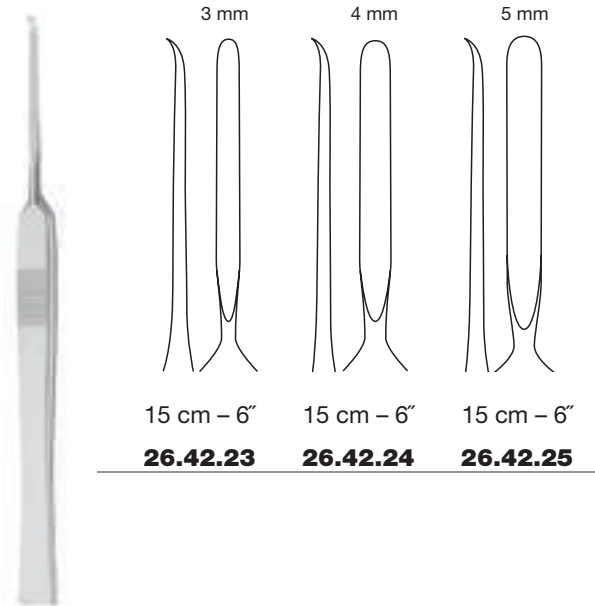

3 mm 4 mm 5 mm

15 cm – 6" 15 cm – 6" 15 cm – 6"

26.42.23 **26.42.24** **26.42.25**

McKenty

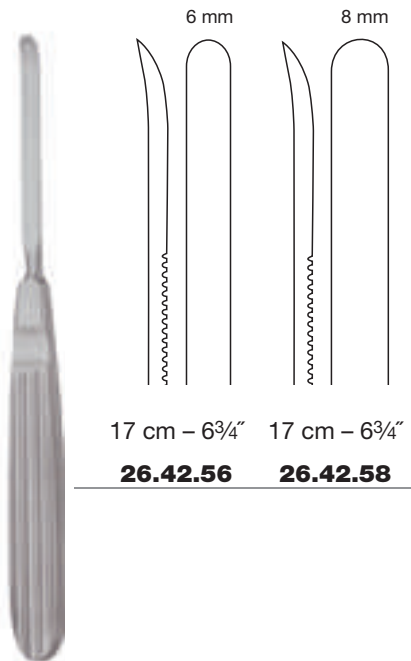

6 mm 8 mm

17 cm – 6¾" 17 cm – 6¾"

26.42.56 **26.42.58**

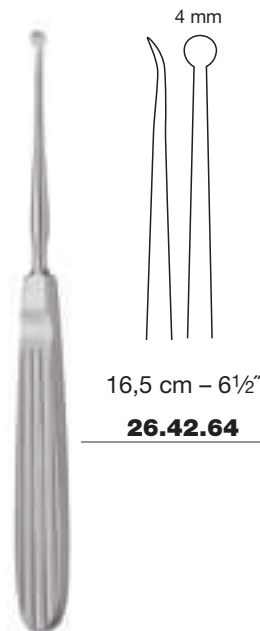

4 mm

16,5 cm – 6½"

26.42.64

Ward

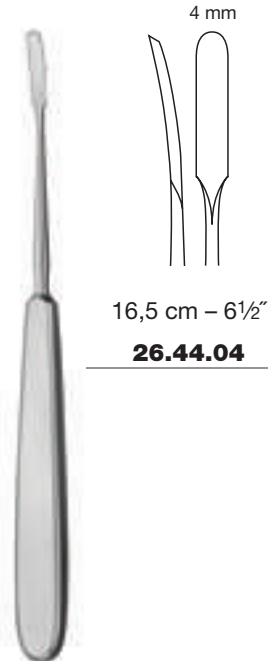

4 mm

16,5 cm – 6½"

26.44.04





Joseph



Raspatorien
Raspatories
Legras
Rugines
Periostotomi

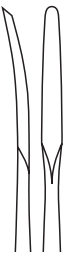
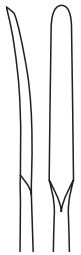

Lempert

				
2 mm	3 mm	4 mm	5 mm	3,5 mm
17 cm – 6¾"	17 cm – 6¾"	17 cm – 6¾"	17 cm – 6¾"	17 cm – 6¾"
26.44.22	26.44.23	26.44.24	26.44.25	26.44.28





Krämer

10 mm
18,5 cm – 7¼"
26.47.32

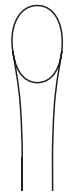

Wiberg

			
4 mm	7 mm	9 mm	12 mm
17 cm – 6¾"	17 cm – 6¾"	17 cm – 6¾"	17 cm – 6¾"
26.45.04	26.45.07	26.45.09	26.45.12
# 1	# 2	# 3	# 4



Krämer

10 mm
19 cm – 7½"
26.47.33



Raspatorien
Raspatories
Legras
Rugines
Periostotomi

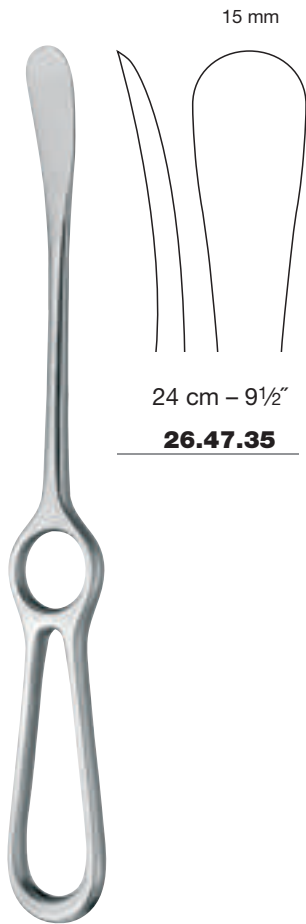

15 mm

24 cm – 9½"

26.47.35

Sedillot

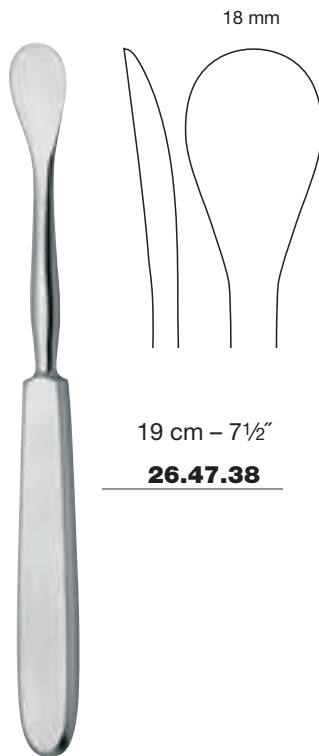

18 mm

19 cm – 7½"

26.47.38

Sedillot

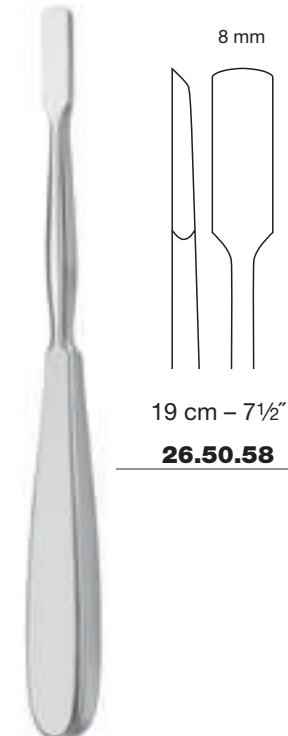

8 mm

19 cm – 7½"

26.50.58

Olivecrona

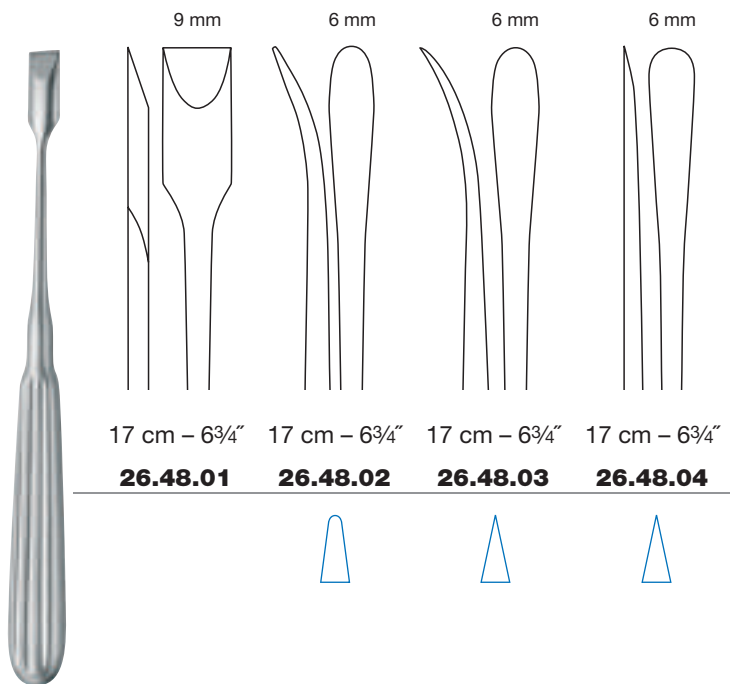

9 mm

6 mm

6 mm

6 mm

17 cm – 6¾"

17 cm – 6¾"

17 cm – 6¾"

17 cm – 6¾"

26.48.01

26.48.02

26.48.03

26.48.04



Adson

 scharf
sharp
cortante
tranchant
tagliante

 stumpf
blunt
roma
mousse
smussa



Raspatorien
Raspatories
Legras
Rugines
Periostotomi

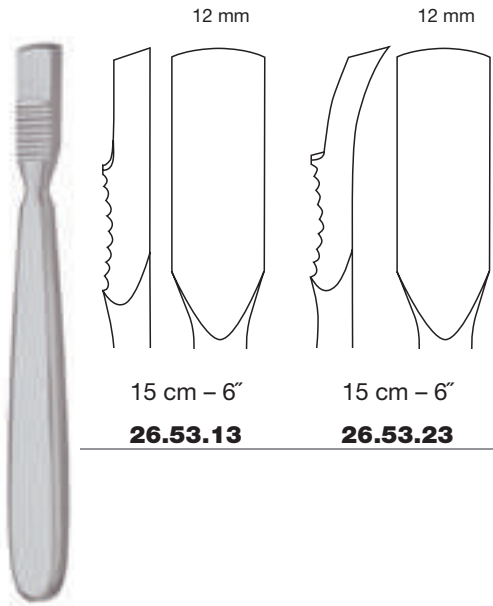

Farabeuf

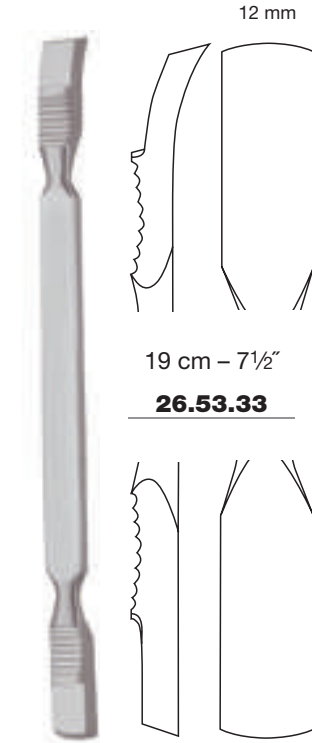

Farabeuf

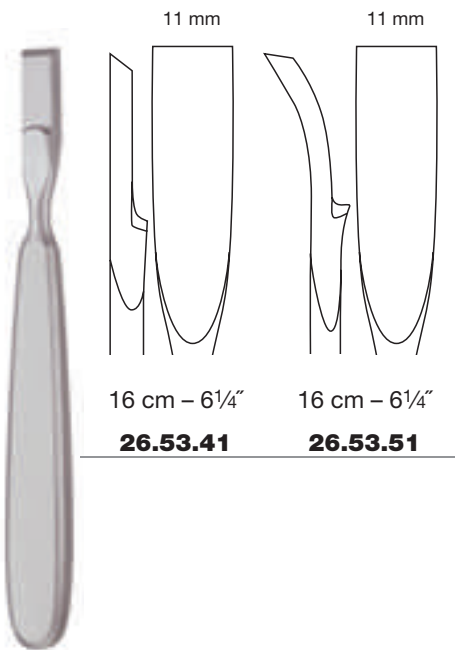

Farabeuf-Collin

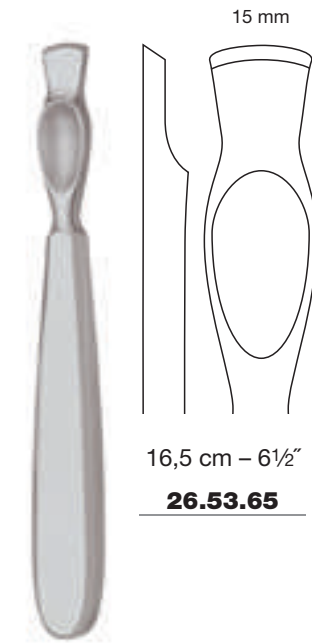

Kirmission



Raspatorien
Raspatories
Legras
Rugines
Periostotomi

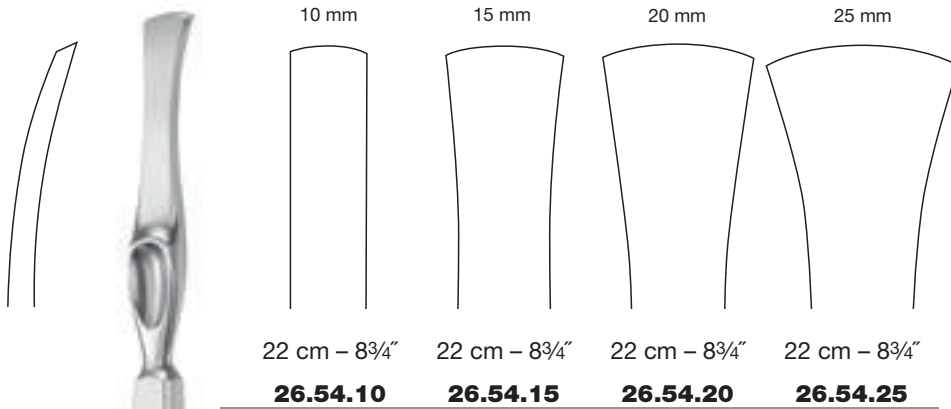

Lambotte



Key

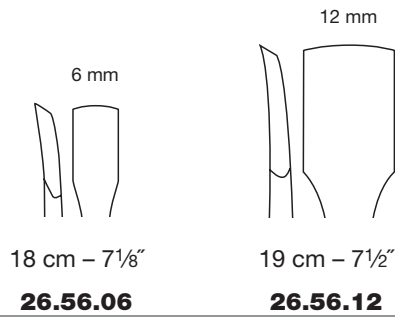

26.56.06

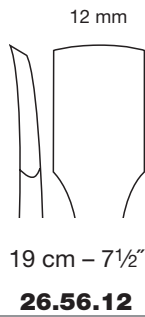

26.56.12

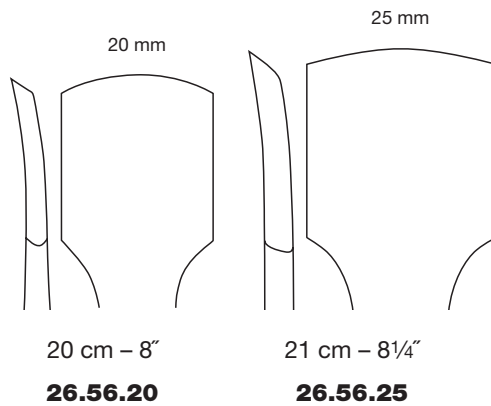

26.56.20

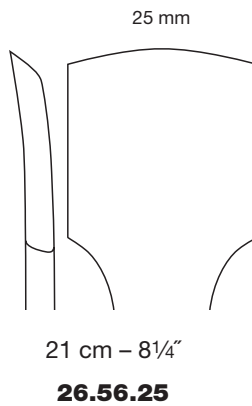

26.56.25



Bristow



Raspatorien
Raspatories
Legras
Rugines
Periostotomi

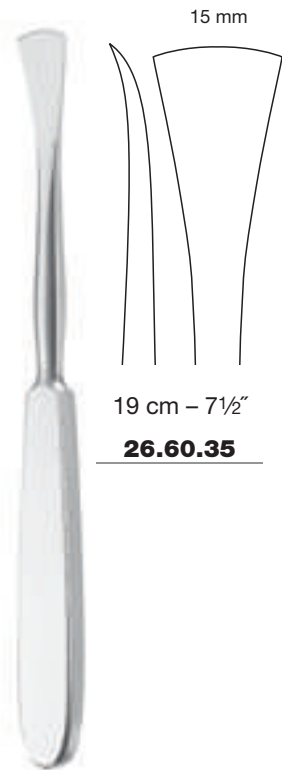

15 mm

19 cm – 7 1/2"

26.60.35

Langenbeck



14 mm

18 cm – 7 1/8"

26.60.63

Langenbeck

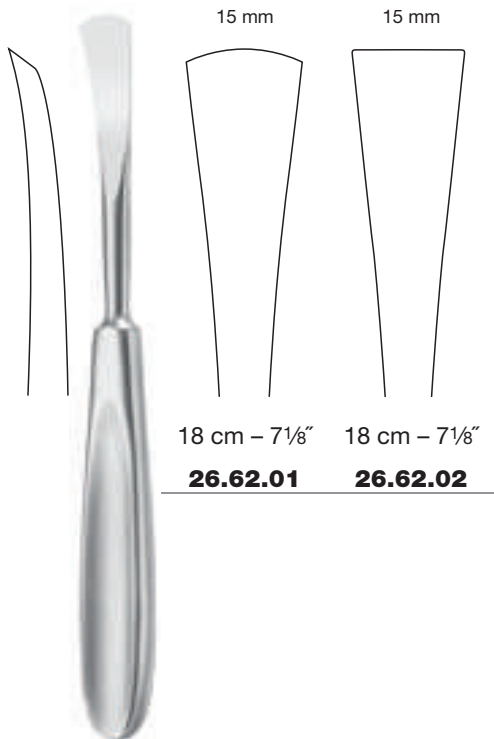

15 mm

15 mm

18 cm – 7 1/8"

18 cm – 7 1/8"

26.62.01

26.62.02

Cushing



Raspatorien
Raspatories
Legras
Rugines
Periostotomi

	6 mm	3 mm	6 mm	6 mm		13 mm
18,5 cm – 7¼"	18,5 cm – 7¼"	18,5 cm – 7¼"	18,5 cm – 7¼"		20 cm – 8"	
26.64.06	26.64.13	26.64.16	26.64.26		26.64.33	
26.64.06P	26.64.13P	26.64.16P	26.64.26P			
					18,5 cm – 7¼"	
					26.64.33P	

	14 mm		13 mm
17,5 cm – 7"		20 cm – 8"	
26.64.75P		26.64.73	



Kunststoffgriff (autoklavierbar bis 134 °C bei 3 bar)
 Plastic handle (autoclavable up to 134 °C at 3 bar)
 Mango de plástico (autoclavable hasta 134 °C bajo presión de 3 bar)
 Manche en plastique (autoclavable à 134 °C sous pression de 3 bars)
 Manico di plastica (autoclavabile fino a 134 °C sotto pressione di 3 bar)



Raspatorien
Raspatories
Legras
Rugines
Periostotomi

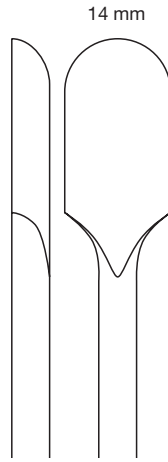

18,5 cm – 7 1/4"

26.64.86P

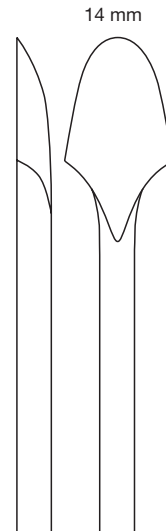

20 cm – 8"

26.64.84

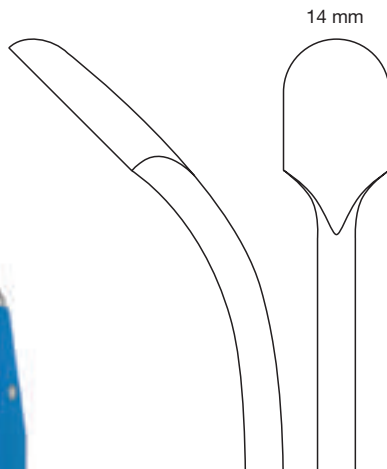

17,5 cm – 7"

26.64.96P

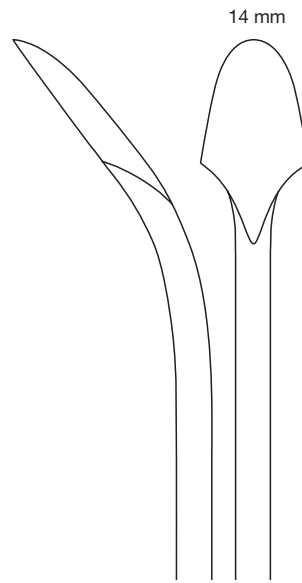

20 cm – 8"

26.64.94



Kunststoffgriff (autoklavierbar bis 134 °C bei 3 bar)
Plastic handle (autoclavable up to 134 °C at 3 bar)
Mango de plástico (autoclavable hasta 134 °C bajo presión de 3 bar)
Manche en plastique (autoclavable à 134 °C sous pression de 3 bars)
Manico di plastica (autoclavabile fino a 134 °C sotto pressione di 3 bar)



Raspatorien
Raspatories
Legras
Rugines
Periostotomi



10 mm

13 mm

19 mm

25 mm

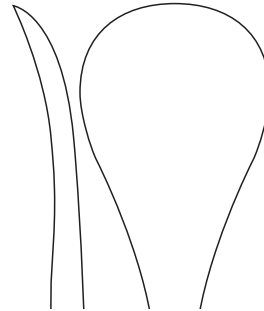
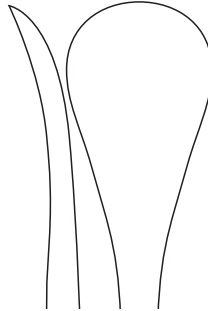
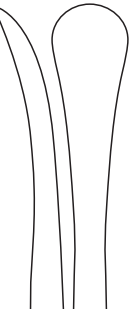

25 cm – 10"

25 cm – 10"

25 cm – 10"

25 cm – 10"

26.65.10

26.65.13

26.65.19

26.65.25



26.65.10P

26.65.13P

26.65.19P

26.65.25P



Cobb



halbscharf
 semi sharp
 semi cortante
 semi tranchant
 semitagliente



Kunststoffgriff (autoklavierbar bis 134 °C bei 3 bar)
 Plastic handle (autoclavable up to 134 °C at 3 bar)
 Mango de plástico (autoclavable hasta 134 °C bajo presión de 3 bar)
 Manche en plastique (autoclavable à 134 °C sous pression de 3 bars)
 Manico di plastica (autoclavabile fino a 134 °C sotto pressione di 3 bar)



Raspatorien
Raspatories
Legras
Rugines
Periostotomi



4 mm



5 mm



6 mm

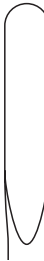

30 cm – 11³/₄"

30 cm – 11³/₄"

30 cm – 11³/₄"

26.66.34

26.66.35

26.66.36



26.66.34P

26.66.35P

26.66.36P



20 mm



28 cm – 11"

26.67.27



26.67.27P



Kunststoffgriff (autoklavierbar bis 134 °C bei 3 bar)
Plastic handle (autoclavable up to 134 °C at 3 bar)
Mango de plástico (autoclavable hasta 134 °C bajo presión de 3 bar)
Manche en plastique (autoclavable à 134 °C sous pression de 3 bars)
Manico di plastica (autoclavabile fino a 134 °C sotto pressione di 3 bar)



Raspatorien
Raspatories
Legras
Rugines
Periostotomi



Wagner

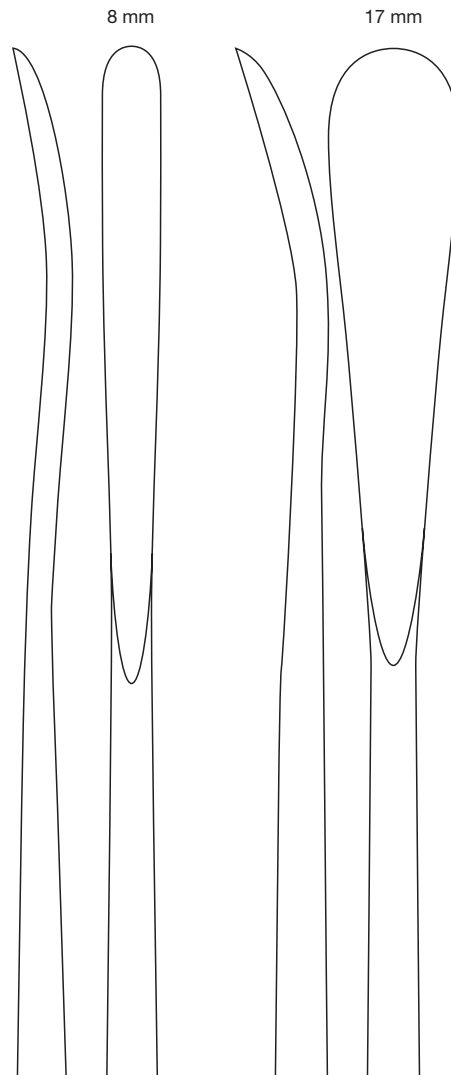

33 cm – 13"

26.67.33

26.67.33P

33 cm – 13"

26.67.34

26.67.34P



Kunststoffgriff (autoklavierbar bis 134 °C bei 3 bar)
 Plastic handle (autoclavable up to 134 °C at 3 bar)
 Mango de plástico (autoclavable hasta 134 °C bajo presión de 3 bar)
 Manche en plastique (autoclavable à 134 °C sous pression de 3 bars)
 Manico di plastica (autoclavabile fino a 134 °C sotto pressione di 3 bar)



Raspatorien
Raspatories
Legras
Rugines
Periostotomi

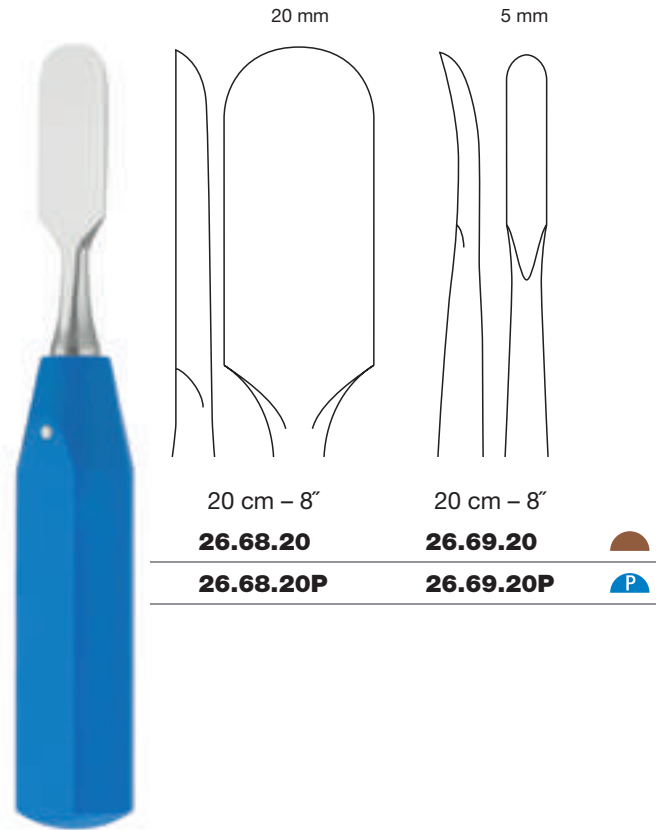
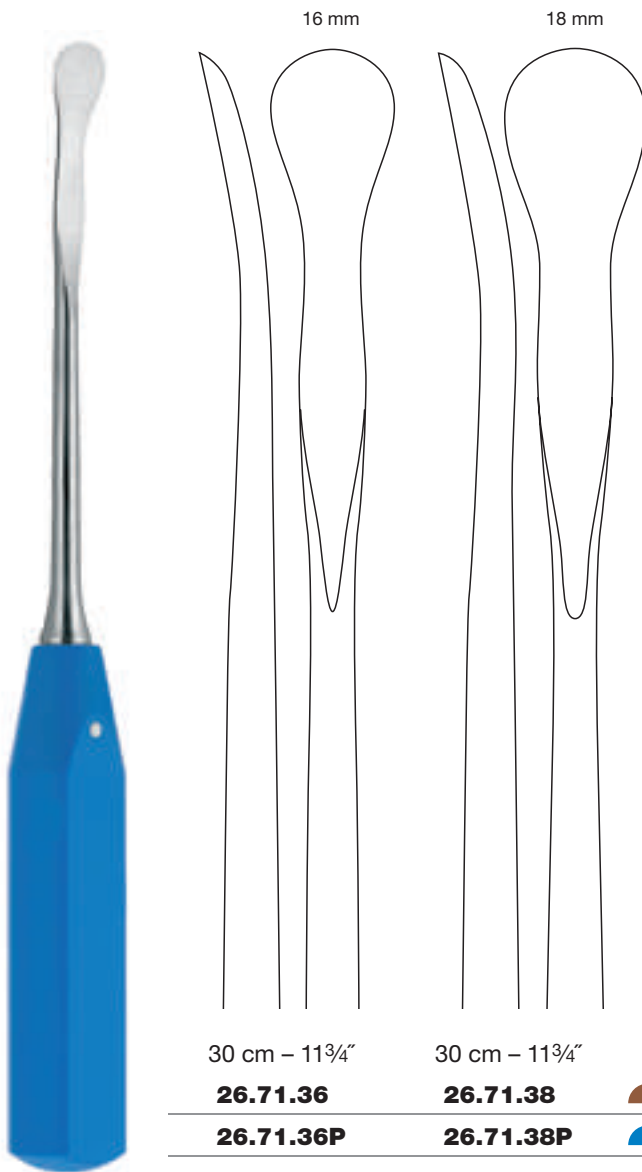

30 cm - 11³/₄"

26.71.36

26.71.36P

30 cm - 11³/₄"

26.71.38

26.71.38P

20 mm

5 mm

20 cm - 8"

26.68.20

26.68.20P

20 cm - 8"

26.69.20

26.69.20P



Kunststoffgriff (autoklavierbar bis 134 °C bei 3 bar)
Plastic handle (autoclavable up to 134 °C at 3 bar)
Mango de plástico (autoclavable hasta 134 °C bajo presión de 3 bar)
Manche en plastique (autoclavable à 134 °C sous pression de 3 bars)
Manico di plastica (autoclavabile fino a 134 °C sotto pressione di 3 bar)



Raspatorien
Raspatories
Legras
Rugines
Periostotomi

	9 mm	13 mm	20 mm
	28 cm - 11"	28 cm - 11"	28 cm - 11"
	26.73.09	26.73.13	26.73.19

	4 mm	6 mm	8 mm
	29 cm - 11 3/8"	29 cm - 11 3/8"	29 cm - 11 3/8"
	26.75.04	26.75.06	26.75.08



Raspatorien
Raspatories
Legras
Rugines
Periostotomi

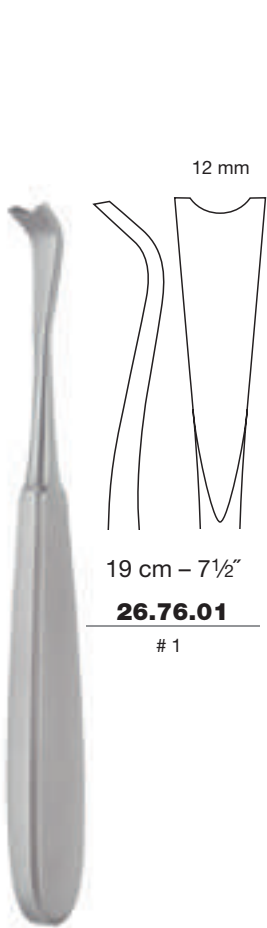

19 cm - 7 1/2"

26.76.01

1

Semb

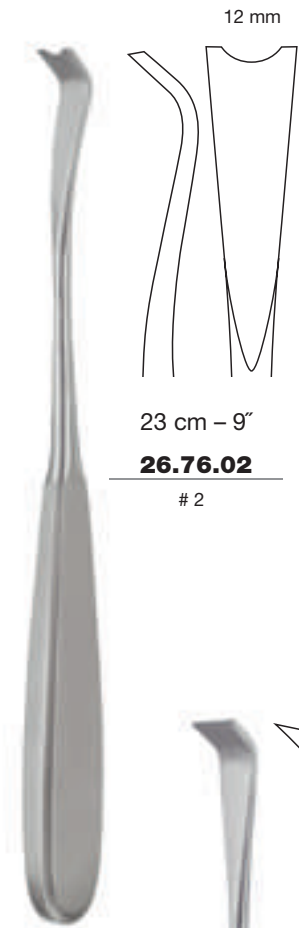

12 mm

23 cm - 9"

26.76.02

2

Semb

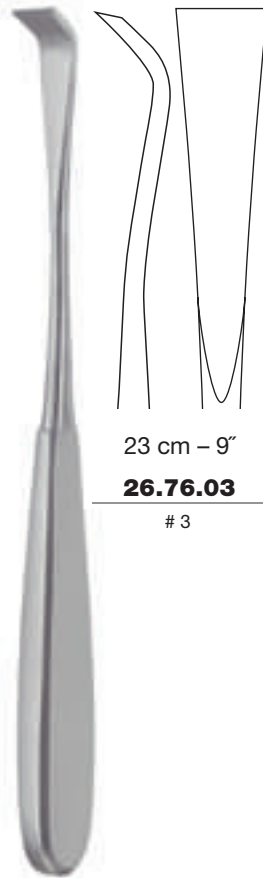

23 cm - 9"

26.76.03

3

Semb

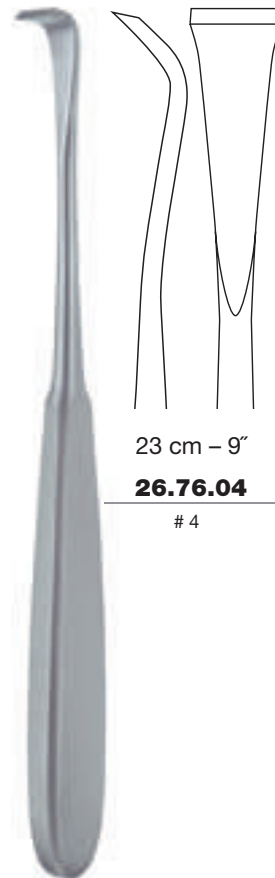

23 cm - 9"

26.76.04

4

Semb

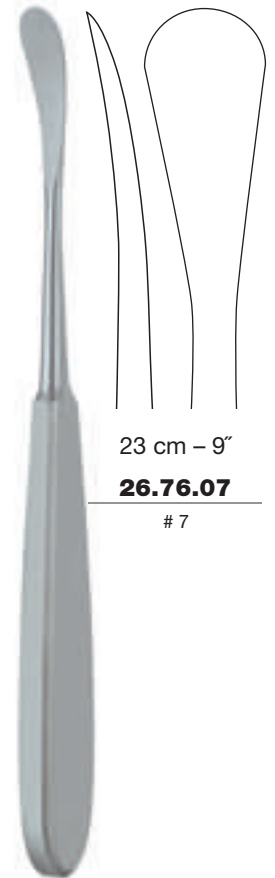

23 cm - 9"

26.76.07

7

Semb



**Hämmer
Mallets
Martillos
Maillets
Martelli**



Hajek

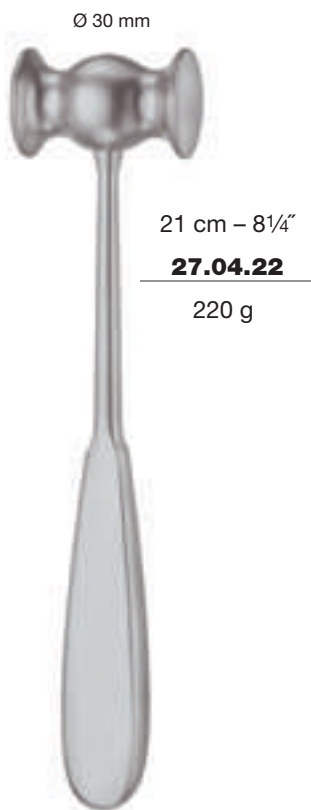

Collin (Lucae)



Doyen



**Hämmer
Mallets
Martillos
Maillets
Martelli**

Ø 30 mm



25 cm – 10"

27.04.35

430 g
bleigefüllt
lead filled head
relleno de plomo
rempli de plomb
pieno di piombo

Williger

Ø 25 mm



18,5 cm – 7¼"

27.06.20

200 g

27.06.21

Ersatzbacken für 27.06.20, Paar
Spare facings for 27.06.20, pair
Frentes de repuesto para 27.06.20, par
Joues de rechange pour 27.06.20, paire
Guance di ricambio per 27.06.20, paio

Ø 26 mm

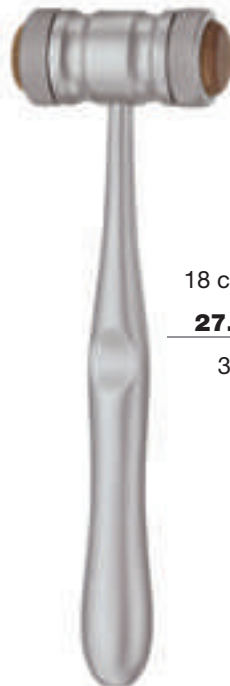

18 cm – 7⅛"

27.06.30

300 g

27.06.31

Ersatzbacken für 27.06.30, Paar
Spare facings for 27.06.30, pair
Frentes de repuesto para 27.06.30, par
Joues de rechange pour 27.06.30, paire
Guance di ricambio per 27.06.30, paio

Mead

Ø 30 mm



18 cm – 7⅛"

27.08.40

400 g
bleigefüllt
lead filled head
relleno de plomo
rempli de plomb
pieno di piombo

Gerzog

**Hämmer
Mallets
Martillos
Maillets
Martelli**

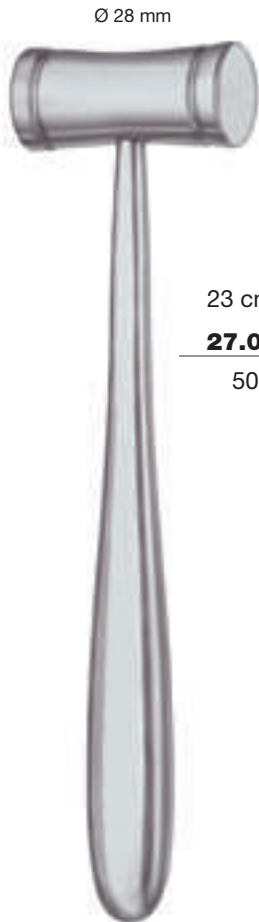

Ø 28 mm

23 cm – 9"

27.08.45

500 g



Ø 30/42 mm

24 cm – 9½"

27.08.50

550 g

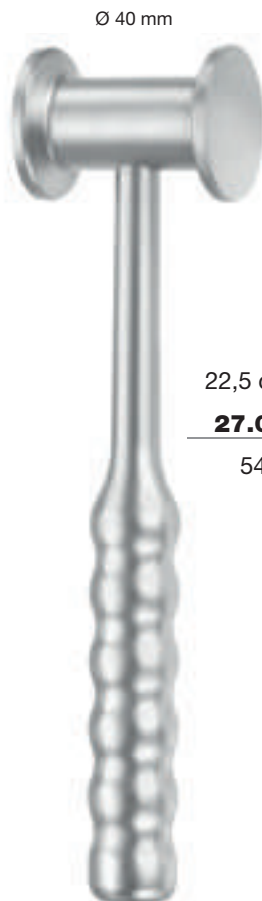

Ø 40 mm

22,5 cm – 9"

27.08.57

540 g

Bergmann (Hibbs)



Ø 40 mm

19,5 cm – 7¾"

27.08.70

700 g

Kirk



Hämmer
Mallets
Martillos
Maillets
Martelli

Ø 40 mm



23 cm – 9"

27.08.77

770 g

Ombredanne

Ø 19 mm



19 cm – 7½"

27.09.19

215 g

Ø 25 mm



23 cm – 9"

27.09.25

350 g



Hämmer
Mallets
Martillos
Maillets
Martelli

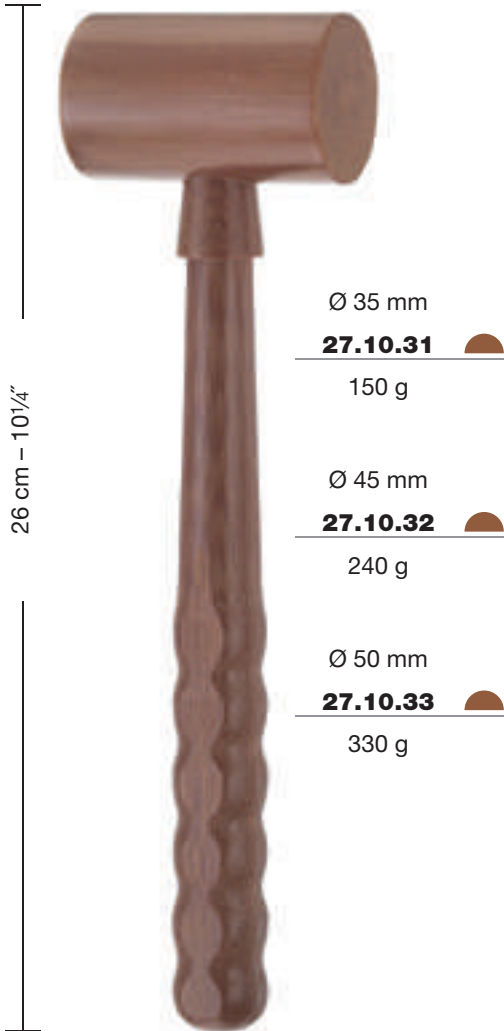

Ø 35 mm
27.10.31 

150 g

Ø 45 mm
27.10.32 

240 g

Ø 50 mm
27.10.33 

330 g



Ø 30 mm

24 cm - 9 1/2"

27.10.50 

380 g



Ø 37 mm

24 cm - 9 1/2"

27.10.60 

360 g

27.10.51

Ersatzbacken für 27.10.50, Paar
Spare facings for 27.10.50, pair
Frentes de repuesto para 27.10.50, par
Joues de rechange pour 27.10.50, paire
Guance di ricambio per 27.10.50, paio

27.10.61

Ersatzbacken für 27.10.60, Paar
Spare facings for 27.10.60, pair
Frentes de repuesto para 27.10.60, par
Joues de rechange pour 27.10.60, paire
Guance di ricambio per 27.10.60, paio



Kunststoffgriff (autoklavierbar bis 134 °C bei 3 bar)
Plastic handle (autoclavable up to 134 °C at 3 bar)
Mango de plástico (autoclavable hasta 134 °C bajo presión de 3 bar)
Manche en plastique (autoclavable à 134 °C sous pression de 3 bars)
Manico di plastica (autoclavabile fino a 134 °C sotto pressione di 3 bar)



Hämmer
Mallets
Martillos
Maillets
Martelli

130 g

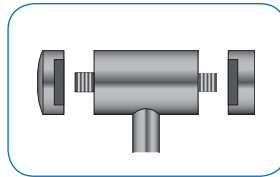

Ø 35 mm / 220 g

**27.10.71**

Metallbacken allein, plan/konvex (Paar)
 Metal facings only, plane/convex (Pair)
 Frentes de metal solas, plana/convexa (Par)
 Jous métalliques seules, plane/convexe (Paire)
 Guance d'acciaio sole, piano/convesso (Paio)

Ø 35 mm / 540 g



24 cm – 9½"

27.10.70

130 g

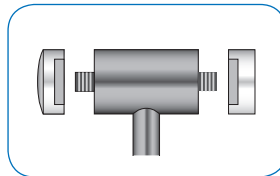

Ø 35 mm / 40 g

**27.10.72**

Kunststoffbacken allein, plan/konvex (Paar)
 Plastic facings only, plane/convex (Pair)
 Frentes de plástico solas, plana/convexa (Par)
 Jous en matière plastique seules, plane/convexe (Paire)
 Guance di plastica sole, piano/convesso (Paio)

komplett mit Metallbacken 27.10.71,
 Kunststoffbacken 27.10.72 und Schlüssel 27.10.73

complete with metal facings 27.10.71,
 plastic facings 27.10.72 and wrench 27.10.73

completo con frentes de metal 27.10.71,
 frentes de plástico 27.10.72 y horquilla 27.10.73

complet avec jous métalliques 27.10.71,
 jous en matière 27.10.72 et clé 27.10.73

completo con guancie d'acciaio 27.10.71,
 guance di plastica 27.10.72 e chiave 27.10.73

Wagner**27.10.73**

Schlüssel allein
 Wrench only
 Horquilla sola
 Clé seule
 Chiave sola



**Flachmeißel
Chisels
Cinceles
Ciseaux burins
Scalpelli**

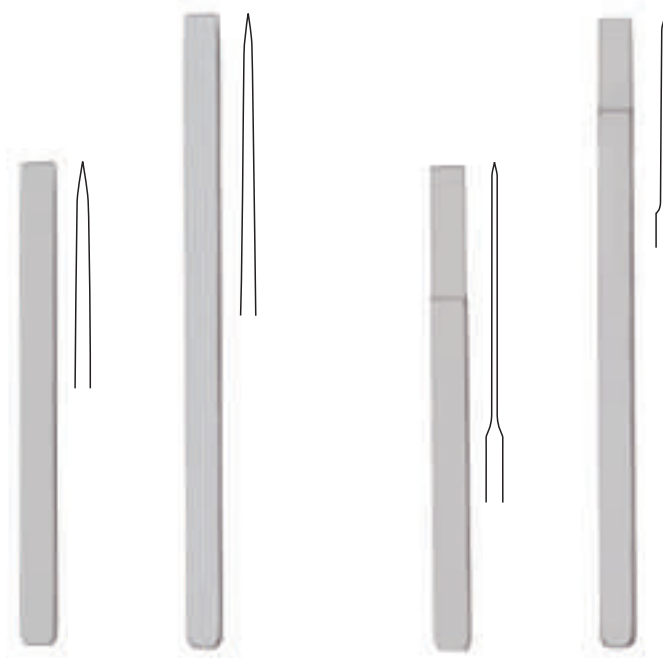

Mini-Lambotte

Hardt-Delima

	13 cm – 5 ¹ / ₈ "	17 cm – 6 ³ / ₄ "	13 cm – 5 ¹ / ₈ "	17 cm – 6 ³ / ₄ "
2 mm	27.57.02	27.57.52	27.58.02	27.58.52
4 mm	27.57.04	27.57.54	27.58.04	27.58.54
6 mm	27.57.06	27.57.56	27.58.06	27.58.56
8 mm	27.57.08	27.57.58	27.58.08	27.58.58
10 mm	27.57.10	27.57.60	27.58.10	27.58.60
12 mm	27.57.12	27.57.62	27.58.12	27.58.62
15 mm	27.57.15	27.57.65	27.58.15	27.58.65
	27.57.90	27.57.95	27.58.90	27.58.95

Satz komplett
Set complete
Juego completo
Série complète
Serie completa

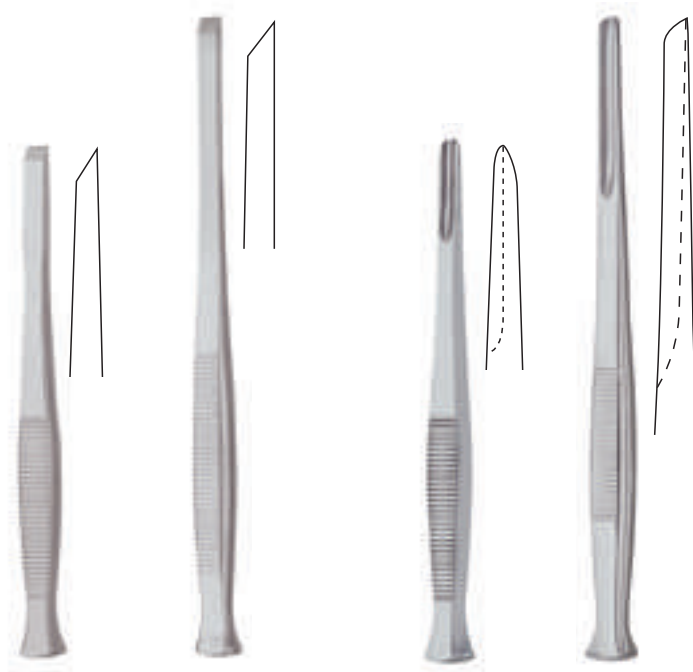

Flach- und Hohlmeißel
Chisels and Gouges
Cinceles y gubias
Ciseaux burins et gouges
Scalpelli e sgorbie

**Partsch****Partsch**

	14 cm – 5½"	17 cm – 6¾"	14 cm – 5½"	17 cm – 6¾"
2 mm	27.61.02	27.61.12	27.61.62	27.61.72
3 mm	27.61.03	27.61.13	27.61.63	27.61.73
4 mm	27.61.04	27.61.14	27.61.64	27.61.74
6 mm	27.61.06	27.61.16	27.61.66	27.61.76
8 mm	27.61.08	27.61.18	27.61.68	27.61.78

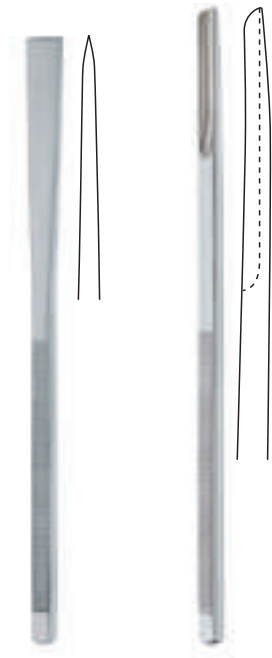
**Sheehan**

	16 cm – 6¼"	16 cm – 6¼"
2 mm	27.62.02	27.62.62
3 mm		27.62.63
4 mm	27.62.04	27.62.64
6 mm	27.62.06	27.62.66
8 mm	27.62.08	
10 mm	27.62.10	
12 mm	27.62.12	
15 mm	27.62.15	
18 mm	27.62.18	
20 mm	27.62.20	



Flach- und Hohlmeißel
Chisels and Gouges
Cinceles y gubias
Ciseaux burins et gouges
Scalpelli e sgorbie

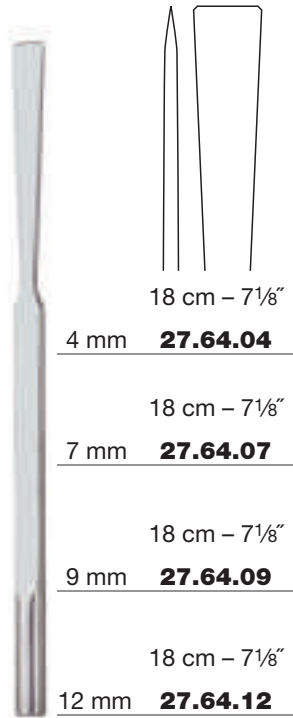

18 cm – 7 1/8"

4 mm **27.64.04**

18 cm – 7 1/8"

7 mm **27.64.07**

18 cm – 7 1/8"

9 mm **27.64.09**

18 cm – 7 1/8"

12 mm **27.64.12**



Cottle-Medicon

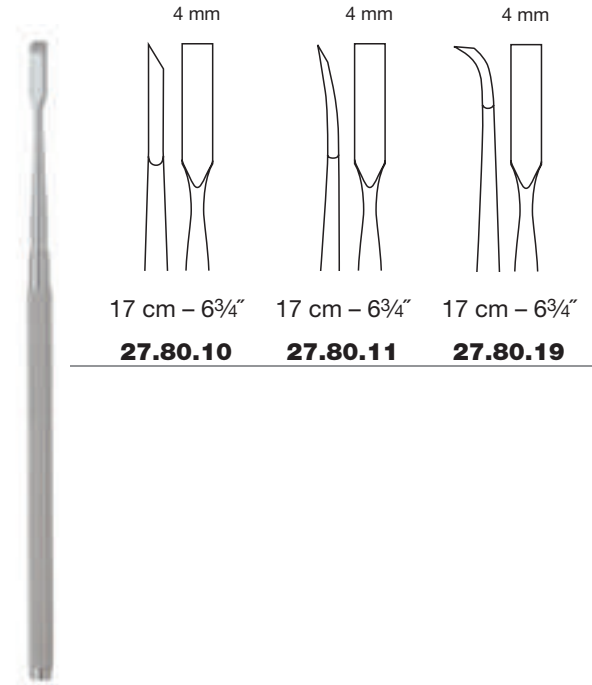

4 mm

4 mm

4 mm

17 cm – 6 3/4"

17 cm – 6 3/4"

17 cm – 6 3/4"

27.80.10

27.80.11

27.80.19

Freer

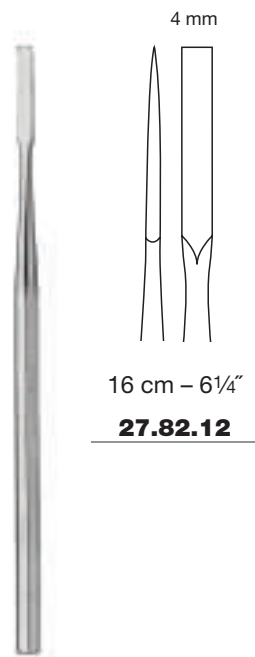

4 mm

16 cm – 6 1/4"

27.82.12

West

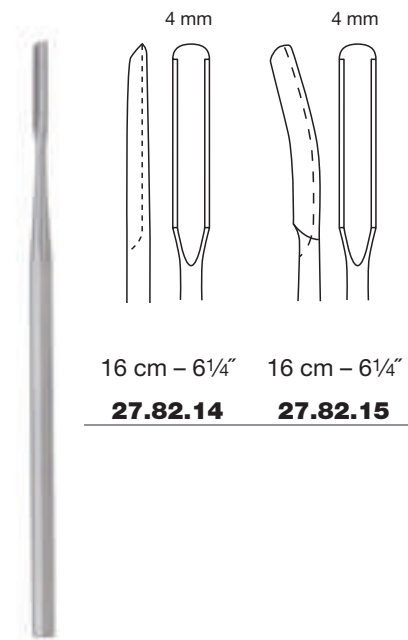

4 mm

4 mm

16 cm – 6 1/4"

16 cm – 6 1/4"

27.82.14

27.82.15

West



Flach- und Hohlmeißel
Chisels and Gouges
Cinceles y gubias
Ciseaux burins et gouges
Scalpelli e sgorbie

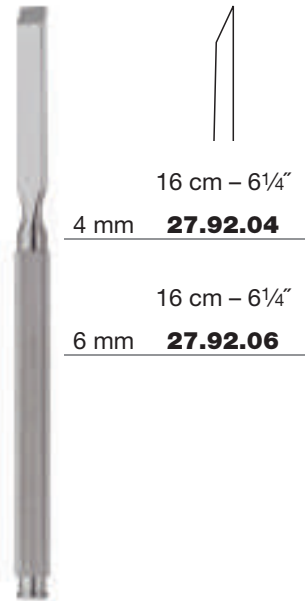

16 cm – 6¼"

4 mm **27.92.04**

16 cm – 6¼"

6 mm **27.92.06**

Brünings

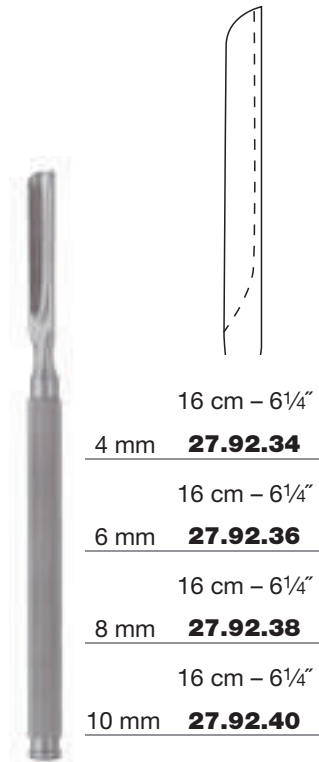

16 cm – 6¼"

4 mm **27.92.34**

16 cm – 6¼"

6 mm **27.92.36**

16 cm – 6¼"

8 mm **27.92.38**

16 cm – 6¼"

10 mm **27.92.40**

Brünings

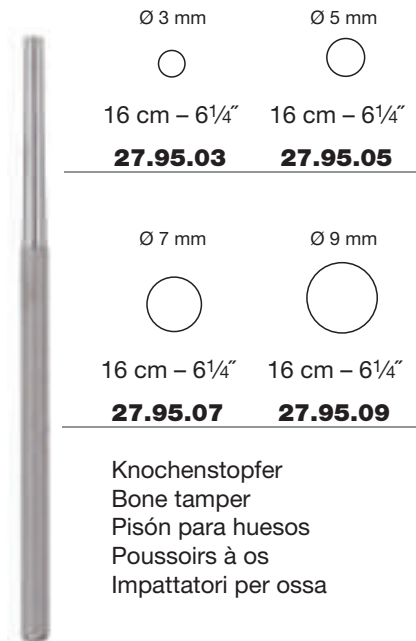

Ø 3 mm

Ø 5 mm

16 cm – 6¼"

16 cm – 6¼"

27.95.03

27.95.05

Ø 7 mm

Ø 9 mm

16 cm – 6¼"

16 cm – 6¼"

27.95.07

27.95.09

Knochenstopfer
Bone tamper
Pisón para huesos
Poussoirs à os
Impattatori per ossa



3 mm

3,5 mm

12 cm – 4¾"

12 cm – 4¾"

27.95.11

27.95.12

Knochenstopfer
Bone tamper
Pisón para huesos
Poussoirs à os
Impattatori per ossa



Passow



**Stößel
Pestles
Pisón
Pilon
Pestello**



Ø 3 mm



20 cm – 8"
27.95.15P 
27.95.15 



Ø 5 mm



20 cm – 8"
27.95.16P 
27.95.16 

Ø 8 mm



20 cm – 8"
27.95.17P 
27.95.17 

Caspar

Ø 12 mm



20 cm – 8"
27.95.20P 
27.95.20 

Ø 14 mm



20 cm – 8"
27.95.21P 
27.95.21 

Ø 16 mm



20 cm – 8"
27.95.22P 
27.95.22 

Caspar



Kunststoffgriff (autoklavierbar bis 134 °C bei 3 bar)
 Plastic handle (autoclavable up to 134 °C at 3 bar)
 Mango de plástico (autoclavable hasta 134 °C bajo presión de 3 bar)
 Manche en plastique (autoclavable à 134 °C sous pression de 3 bars)
 Manico di plastica (autoclavabile fino a 134 °C sotto pressione di 3 bar)



Flach- und Hohlmeißel
Chisels and Gouges
Cinceles y gubias
Ciseaux burins et gouges
ScalPELLI e sgorbie

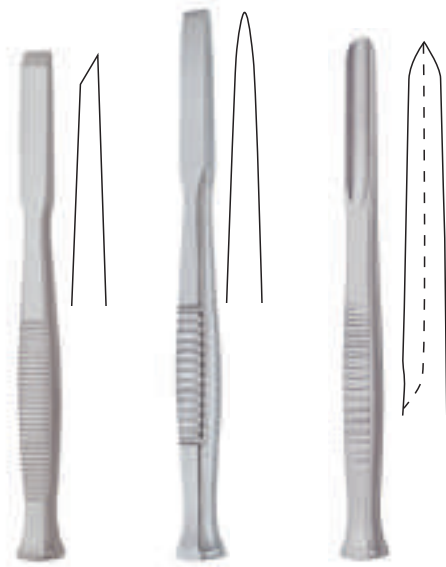

	14 cm – 5½"	14 cm – 5½"	14 cm – 5½"
3 mm		28.05.03	28.06.03
4 mm	28.04.04	28.05.04	28.06.04
5 mm		28.05.05	28.06.05
6 mm	28.04.06	28.05.06	28.06.06
8 mm	28.04.08	28.05.08	28.06.08
10 mm	28.04.10	28.05.10	28.06.10
12 mm	28.04.12	28.05.12	28.06.12

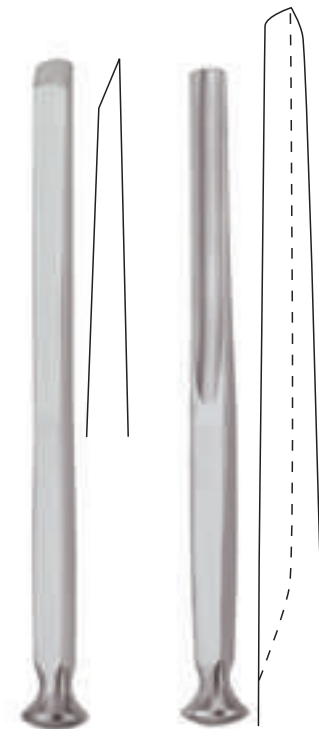
**Alexander**

	18 cm – 7¼"	18 cm – 7¼"
4 mm	28.26.04	28.28.04
6 mm	28.26.06	28.28.06
8 mm	28.26.08	28.28.08
10 mm	28.26.10	28.28.10
12 mm	28.26.12	28.28.12
14 mm	28.26.14	28.28.14



Flach- und Hohlmeißel
Chisels and Gouges
Cinceles y gubias
Ciseaux burins et gouges
Scalpelli e sgorbie

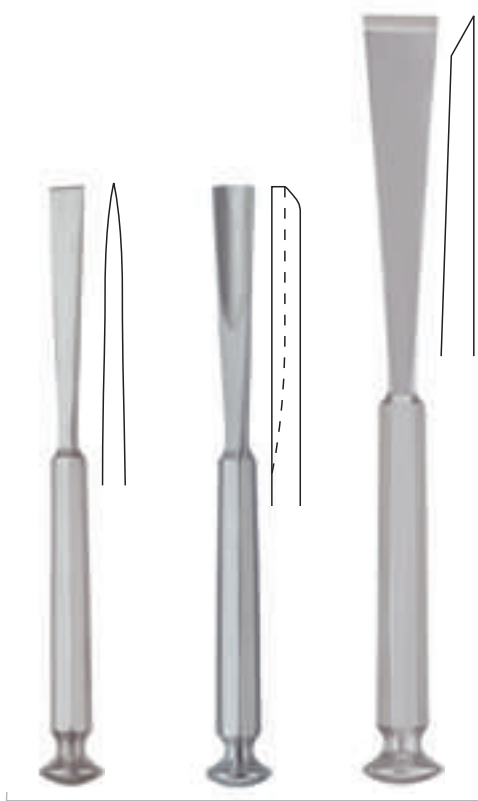

Stille

	16 cm – 6¼"	16 cm – 6¼"	20 cm – 8"
4 mm	28.41.04		
6 mm	28.41.06	28.42.06	
8 mm	28.41.08	28.42.08	
10 mm	28.41.10	28.42.10	28.43.10
12 mm	28.41.12	28.42.12	
15 mm	28.41.15	28.42.15	28.43.15
20 mm			28.43.20
25 mm			28.43.25

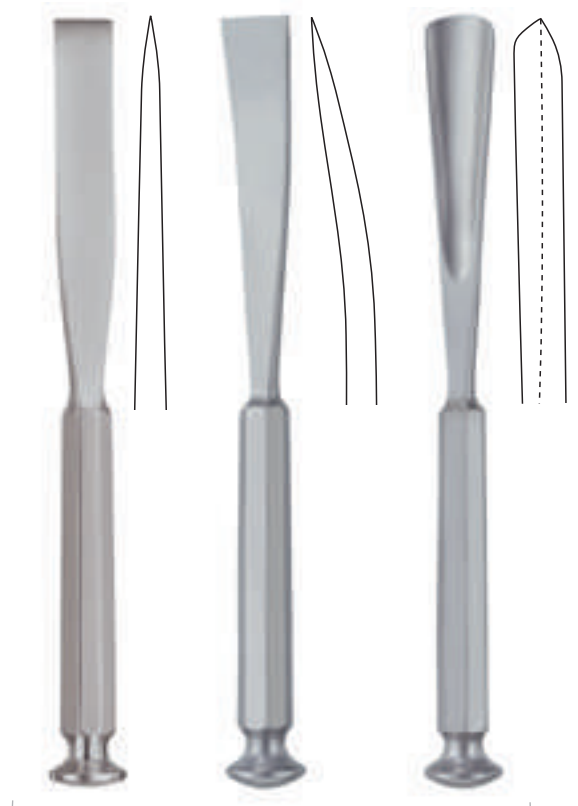

Stille

	20 cm – 8"	20 cm – 8"	20 cm – 8"
4 mm	28.44.04		
6 mm	28.44.06		
8 mm	28.44.08		28.45.08
10 mm	28.44.10	28.44.60	28.45.10
12 mm	28.44.12		28.45.12
15 mm	28.44.15	28.44.65	28.45.15
20 mm	28.44.20	28.44.70	28.45.20
25 mm	28.44.25	28.44.75	28.45.25

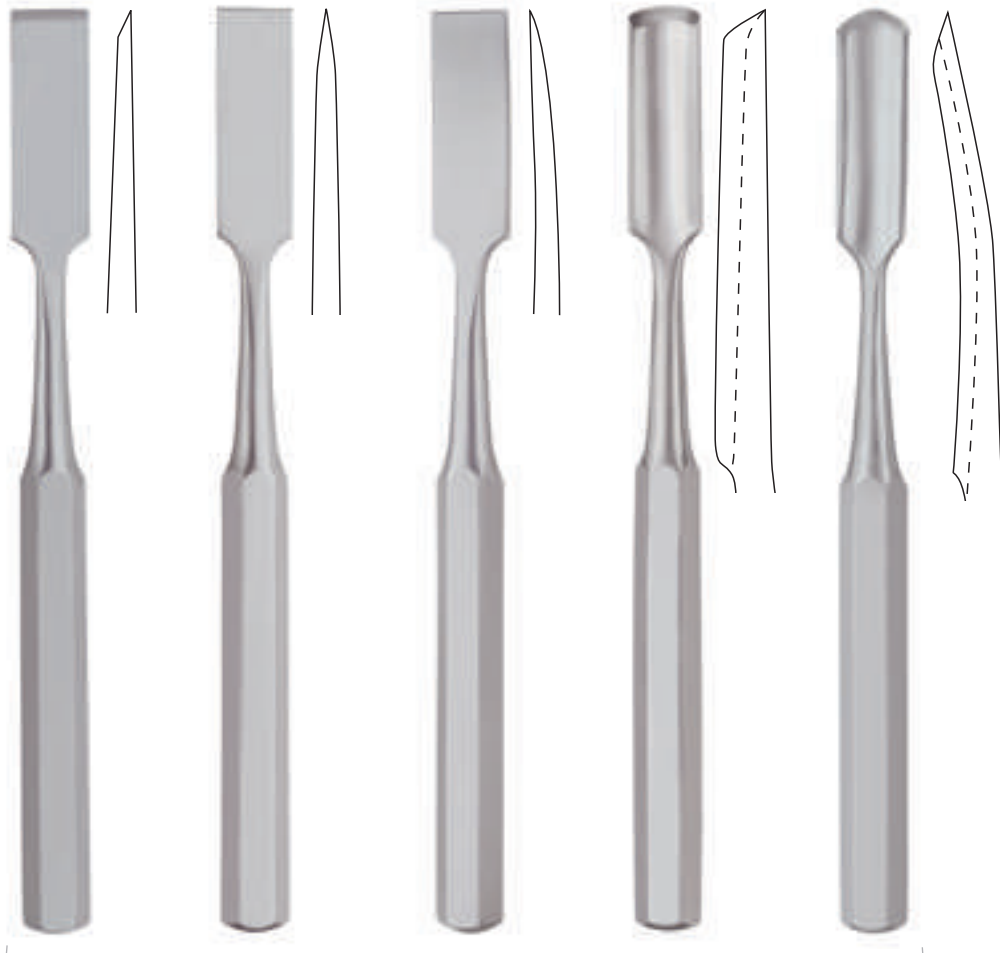

Flach- und Hohlmeißel
Chisels and Gouges
Cinceles y gubias
Ciseaux burins et gouges
ScalPELLi e sgorbie

**Hibbs**

	24 cm – 9½"	24 cm – 9½"	24 cm – 9½"	24 cm – 9½"	24 cm – 9½"
6 mm	28.50.06	28.51.06	28.51.56	28.52.06	28.52.56
12 mm	28.50.12	28.51.12	28.51.62	28.52.12	28.52.62
20 mm	28.50.20	28.51.20	28.51.70	28.52.20	28.52.70
25 mm	28.50.25	28.51.25	28.51.75	28.52.25	28.52.75
30 mm	28.50.30	28.51.30	28.51.80	28.52.30	28.52.80
40 mm	28.50.40	28.51.40	28.51.90	28.52.40	28.52.90



Flach- und Hohlmeißel
Chisels and Gouges
Cinceles y gubias
Ciseaux burins et gouges
ScalPELLI e sgorbie



Mini-Lexer

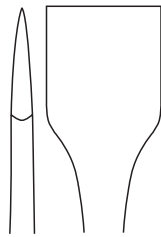

18 cm – 7 1/8"

18 cm – 7 1/8"



2 mm	28.61.02	28.61.02P
4 mm	28.61.04	28.61.04P
6 mm	28.61.06	28.61.06P
8 mm	28.61.08	28.61.08P
10 mm	28.61.10	28.61.10P
12 mm	28.61.12	28.61.12P
15 mm	28.61.15	28.61.15P
20 mm	28.61.20	28.61.20P

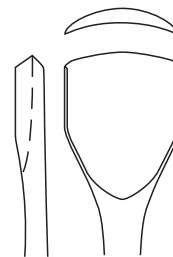

18 cm – 7 1/8"

18 cm – 7 1/8"



2 mm	28.62.02	28.62.02P
4 mm	28.62.04	28.62.04P
6 mm	28.62.06	28.62.06P
8 mm	28.62.08	28.62.08P
10 mm	28.62.10	28.62.10P
12 mm	28.62.12	28.62.12P
15 mm	28.62.15	28.62.15P
20 mm	28.62.20	28.62.20P

Mini-Lexer



Kunststoffgriff (autoklavierbar bis 134 °C bei 3 bar)
 Plastic handle (autoclavable up to 134 °C at 3 bar)
 Mango de plástico (autoclavable hasta 134 °C bajo presión de 3 bar)
 Manche en plastique (autoclavable à 134 °C sous pression de 3 bars)
 Manico di plastica (autoclavabile fino a 134 °C sotto pressione di 3 bar)



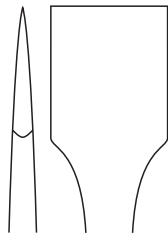

Flach- und Hohlmeißel
Chisels and Gouges
Cinceles y gubias
Ciseaux burins et gouges
Scalpelli e sgorbie

**Lexer**

22 cm – 8¾"

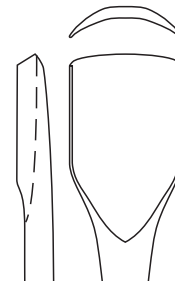

22 cm – 8¾"

		
7 mm	28.64.07	28.64.07P
10 mm	28.64.10	28.64.10P
12 mm	28.64.12	28.64.12P
15 mm	28.64.15	28.64.15P
20 mm	28.64.20	28.64.20P
25 mm	28.64.25	28.64.25P
30 mm	28.64.30	28.64.30P



22 cm – 8¾"

22 cm – 8¾"

		
7 mm	28.65.07	28.65.07P
10 mm	28.65.10	28.65.10P
12 mm	28.65.12	28.65.12P
15 mm	28.65.15	28.65.15P
20 mm	28.65.20	28.65.20P
25 mm	28.65.25	28.65.25P
30 mm	28.65.30	28.65.30P

**Lexer**

Kunststoffgriff (autoklavierbar bis 134 °C bei 3 bar)
 Plastic handle (autoclavable up to 134 °C at 3 bar)
 Mango de plástico (autoclavable hasta 134 °C bajo presión de 3 bar)
 Manche en plastique (autoclavable à 134 °C sous pression de 3 bars)
 Manico di plastica (autoclavabile fino a 134 °C sotto pressione di 3 bar)



Hohlmeißel
Gouges
Gubias
Gouges
Sgorbie



Cobb

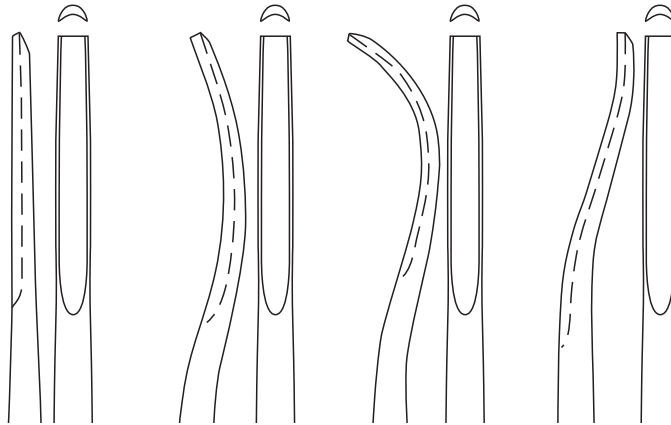

28 cm – 11"

28.65.91

28.65.91P

28 cm – 11"

28.65.92

28.65.92P

28 cm – 11"

28.65.93

28.65.93P

28 cm – 11"

28.65.95

28.65.95P



Kunststoffgriff (autoklavierbar bis 134 °C bei 3 bar)
 Plastic handle (autoclavable up to 134 °C at 3 bar)
 Mango de plástico (autoclavable hasta 134 °C bajo presión de 3 bar)
 Manche en plastique (autoclavable à 134 °C sous pression de 3 bars)
 Manico di plastica (autoclavabile fino a 134 °C sotto pressione di 3 bar)



Hohlmeißel
Gouges
Gubias
Gouges
Sgorbie



Lexer

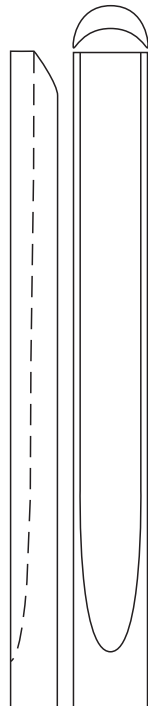

25 cm – 10"



5 mm

28.65.55

10 mm

28.65.60

15 mm

28.65.65

25 cm – 10"



28.65.55P

28.65.60P

28.65.65P



Lexer

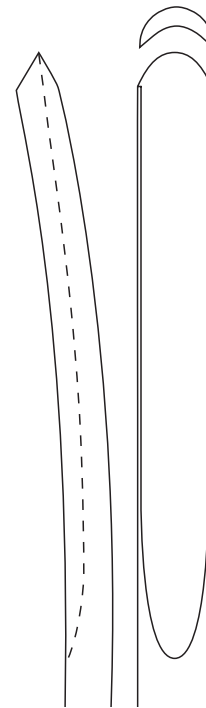

25 cm – 10"



5 mm

28.65.75

10 mm

28.65.80

15 mm

28.65.85

25 cm – 10"



28.65.75P

28.65.80P

28.65.85P



Kunststoffgriff (autoklavierbar bis 134 °C bei 3 bar)
Plastic handle (autoclavable up to 134 °C at 3 bar)
Mango de plástico (autoclavable hasta 134 °C bajo presión de 3 bar)
Manche en plastique (autoclavable à 134 °C sous pression de 3 bars)
Manico di plastica (autoclavabile fino a 134 °C sotto pressione di 3 bar)



**Flachmeißel
Chisels
Cinceles
Ciseaux burins
Scalpelli**



Dahmen

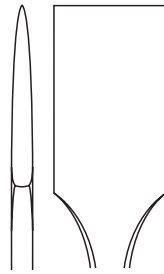

30 cm – 11¾"

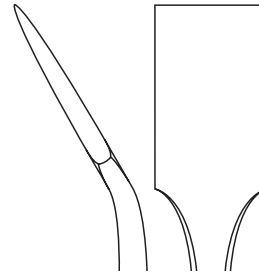

30 cm – 11¾"



4 mm	28.66.04	28.66.04P	28.66.34	28.66.34P
5 mm	28.66.05	28.66.05P	28.66.35	28.66.35P
6 mm	28.66.06	28.66.06P	28.66.36	28.66.36P
8 mm	28.66.08	28.66.08P	28.66.38	28.66.38P
10 mm	28.66.10	28.66.10P	28.66.40	28.66.40P
12 mm	28.66.12	28.66.12P	28.66.42	28.66.42P
15 mm	28.66.15	28.66.15P	28.66.45	28.66.45P
20 mm	28.66.20	28.66.20P	28.66.50	28.66.50P
22 mm	28.66.22	28.66.22P	28.66.52	28.66.52P
25 mm	28.66.25	28.66.25P	28.66.55	28.66.55P







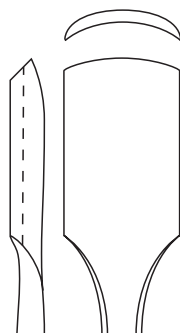
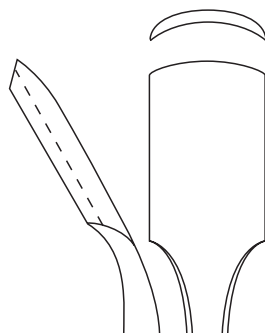
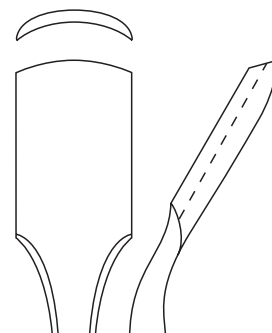

Kunststoffgriff (autoklavierbar bis 134 °C bei 3 bar)
 Plastic handle (autoclavable up to 134 °C at 3 bar)
 Mango de plástico (autoclavable hasta 134 °C bajo presión de 3 bar)
 Manche en plastique (autoclavable à 134 °C sous pression de 3 bars)
 Manico di plastica (autoclavabile fino a 134 °C sotto pressione di 3 bar)



Hohlmeißel
Gouges
Gubias
Gouges
Sgorbie

**Dahmen**30 cm – 11³/₄"30 cm – 11³/₄"30 cm – 11³/₄"

						
4 mm	28.67.04	28.67.04P	28.67.34	28.67.34P	28.67.64	28.67.64P
5 mm	28.67.05	28.67.05P	28.67.35	28.67.35P	28.67.65	28.67.65P
6 mm	28.67.06	28.67.06P	28.67.36	28.67.36P	28.67.66	28.67.66P
8 mm	28.67.08	28.67.08P	28.67.38	28.67.38P	28.67.68	28.67.68P
10 mm	28.67.10	28.67.10P	28.67.40	28.67.40P	28.67.70	28.67.70P
12 mm	28.67.12	28.67.12P	28.67.42	28.67.42P	28.67.72	28.67.72P
15 mm	28.67.15	28.67.15P	28.67.45	28.67.45P	28.67.75	28.67.75P
20 mm	28.67.20	28.67.20P	28.67.50	28.67.50P	28.67.80	28.67.80P
22 mm	28.67.22	28.67.22P	28.67.52	28.67.52P	28.67.82	28.67.82P
25 mm	28.67.25		28.67.55		28.67.85	



Kunststoffgriff (autoklavierbar bis 134 °C bei 3 bar)
 Plastic handle (autoclavable up to 134 °C at 3 bar)
 Mango de plástico (autoclavable hasta 134 °C bajo presión de 3 bar)
 Manche en plastique (autoclavable à 134 °C sous pression de 3 bars)
 Manico di plastica (autoclavabile fino a 134 °C sotto pressione di 3 bar)



**Flach- und Hohlmeißel
Chisels and Gouges
Cinceles y gubias
Ciseaux burins et gouges
Scalpelli e sgorbie**

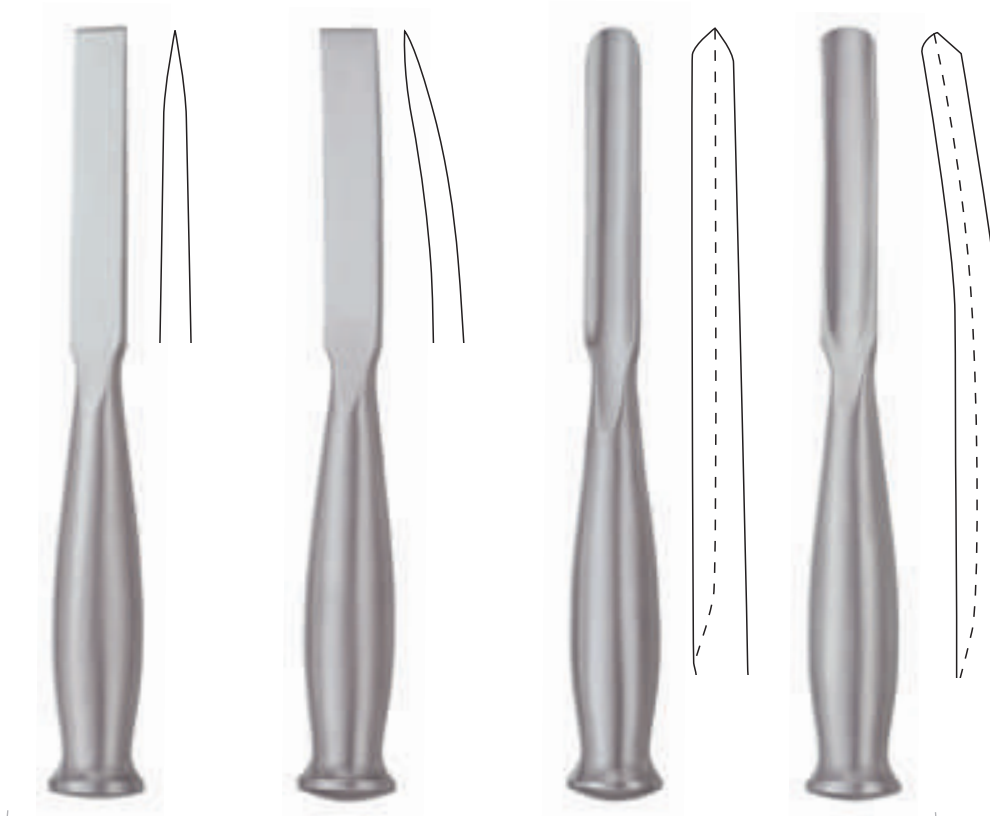

Smith-Petersen

	20 cm – 8"	20 cm – 8"	20 cm – 8"	20 cm – 8"
6 mm	28.71.06	28.71.56	28.72.06	28.72.56
9 mm	28.71.09	28.71.59	28.72.09	28.72.59
12 mm	28.71.12	28.71.62	28.72.12	28.72.62
15 mm	28.71.15	28.71.65	28.72.15	28.72.65
20 mm	28.71.20	28.71.70	28.72.20	28.72.70
25 mm	28.71.25	28.71.75	28.72.25	28.72.75
30 mm	28.71.30	28.71.80	28.72.30	28.72.80



Flach- und Hohlmeißel
Chisels and Gouges
Cinceles y gubias
Ciseaux burins et gouges
Scalpelli e sgorbie



18,5 cm – 7¼"

28.53.00



28.53.04

Ersatzschraube
 Spare screw
 Tornillo de repuesto
 Vis de rechange
 Vite di ricambio



9 cm – 3½"

28.53.02

Spannschlüssel
 Wrench
 Llave tensora
 Clé de tension
 Chiave regolare

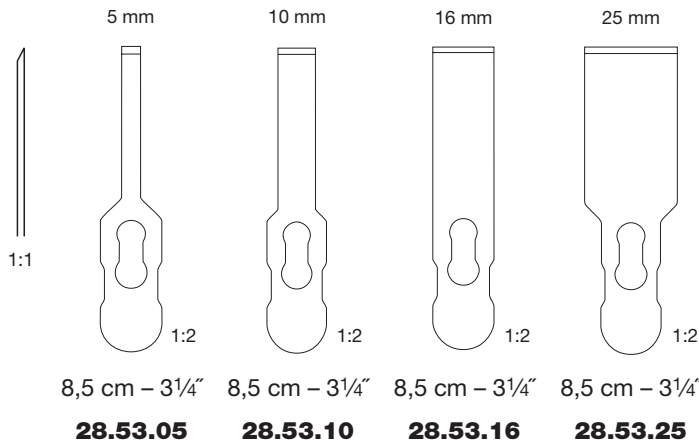

Flachmeißelklingen
 Chisel blades
 Hojas de cincel
 Lames ciseaux burin
 Lame per scalpello



**Flach- und Hohlmeißel
Chisels and Gouges
Cinceles y gubias
Ciseaux burins et gouges
Scalpelli e sgorbie**

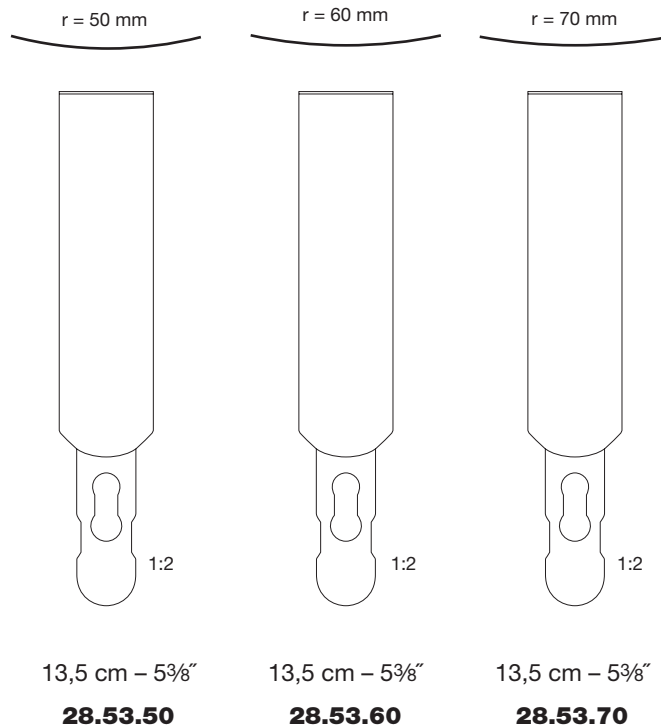

Hohlmeißelklingen
Gouge blades
Hojas de gubia
Lames gouges
Lame per sgorbie

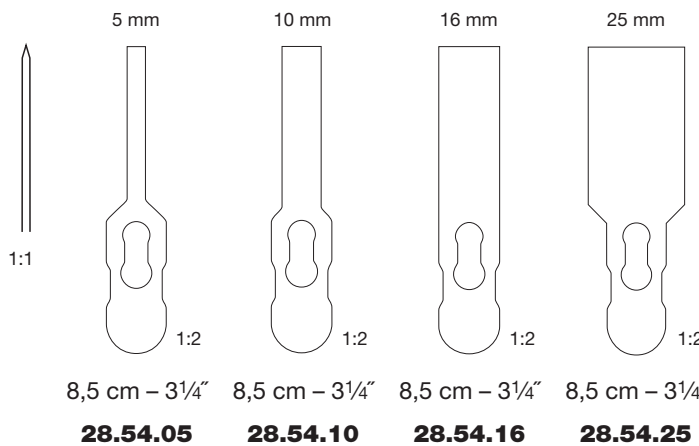

Osteotomklingen
Osteotome blades
Hojas de osteótomo
Lames ostéotome
Lame per osteotomia



Flachmeißel
Chisels
Cinceles
Ciseaux burins
Scalpelli

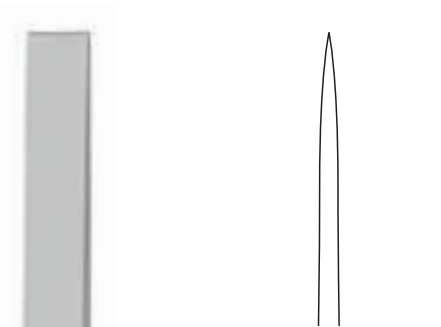

24 cm – 9½"

4 mm	28.94.04
6 mm	28.94.06
8 mm	28.94.08
10 mm	28.94.10
12 mm	28.94.12
15 mm	28.94.15
20 mm	28.94.20
25 mm	28.94.25
30 mm	28.94.30
40 mm	28.94.40
44 mm	28.94.44
50 mm	28.94.50

Lambotte

24 cm – 9½"

4 mm	28.94.54
6 mm	28.94.56
8 mm	28.94.58
10 mm	28.94.60
12 mm	28.94.62
15 mm	28.94.65
20 mm	28.94.70
25 mm	28.94.75
30 mm	28.94.80
40 mm	28.94.90
44 mm	28.94.94
50 mm	28.94.99

Lambotte



Scharfe Löffel
Sharp Curettes
Cucharillas cortantes
Curettes tranchantes
Cucchiai taglienti

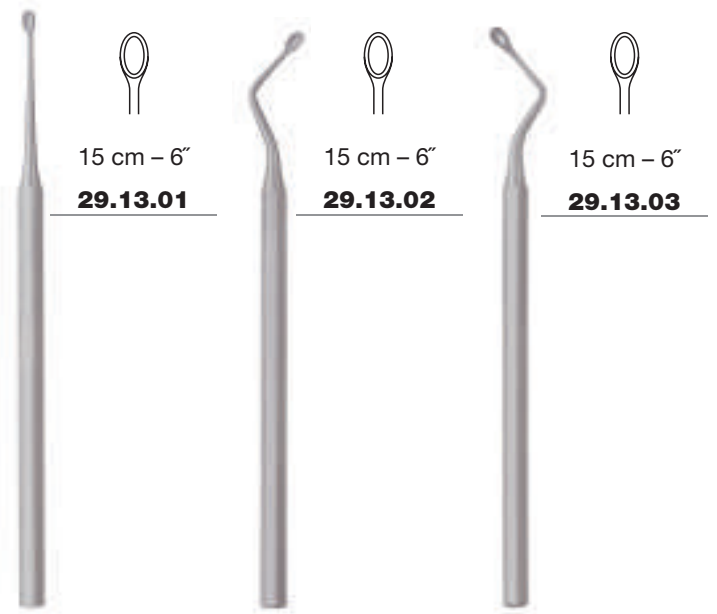
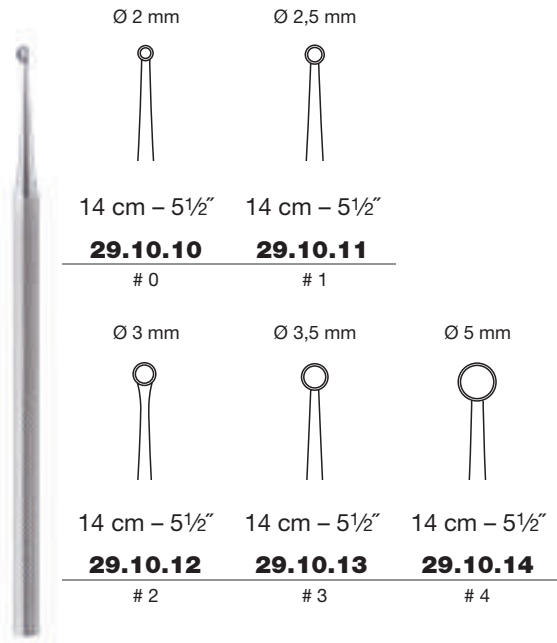

Meyhoefer

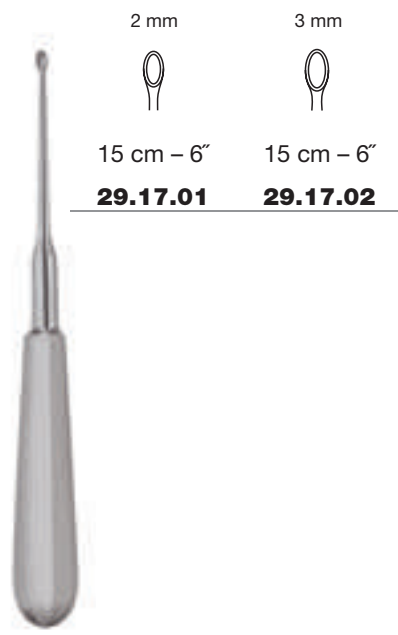

Kerpel

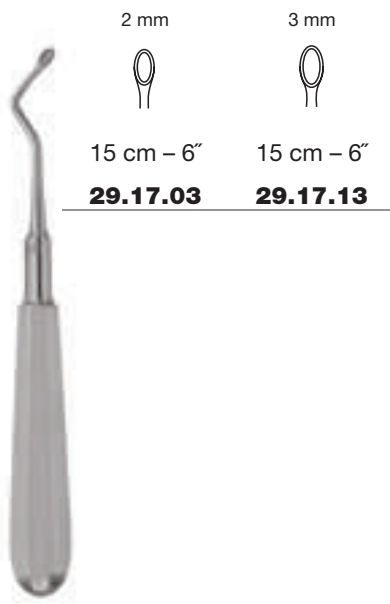

Kerpel

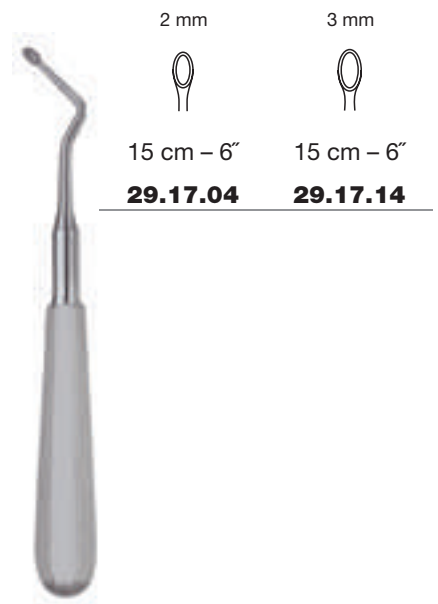

Kerpel



Scharfe Löffel
Sharp Curettes
Cucharillas cortantes
Curettes tranchantes
Cucchiai taglienti

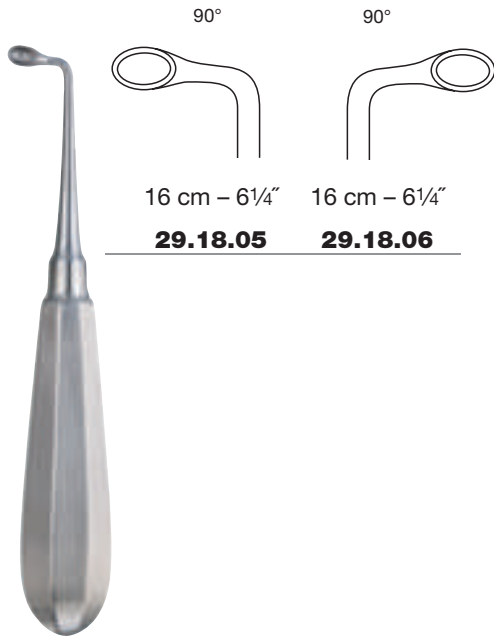

90° 90°
16 cm – 6¼" 16 cm – 6¼"
29.18.05 **29.18.06**

Siebenmann

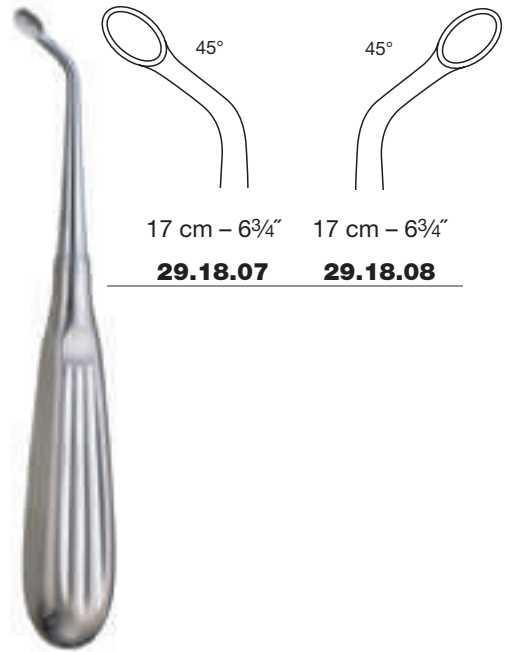

45° 45°
17 cm – 6¾" 17 cm – 6¾"
29.18.07 **29.18.08**

Uffendorde

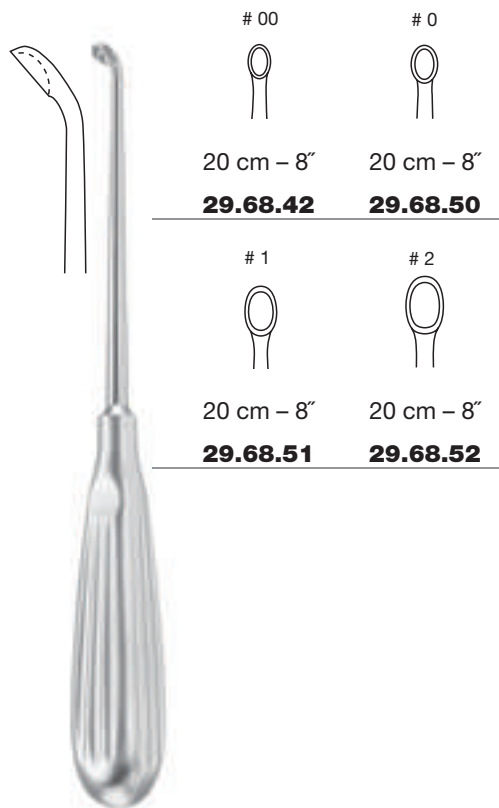

00 # 0
20 cm – 8" 20 cm – 8"
29.68.42 **29.68.50**
1 # 2
20 cm – 8" 20 cm – 8"
29.68.51 **29.68.52**





Daubenspeck



Scharfe Löffel
Sharp Curettes
Cucharillas cortantes
Curettes tranchantes
Cucchiai taglienti







Buck

# 1	# 2	# 3
		
14,5 cm – 5¾"	14,5 cm – 5¾"	14,5 cm – 5¾"
29.20.01	29.20.02	29.20.03
# 4	# 5	
		
14,5 cm – 5¾"	14,5 cm – 5¾"	
29.20.04	29.20.05	











Williger

# 1 - 4 mm	# 2 - 5 mm
	
17 cm – 6¾"	17 cm – 6¾"
29.24.01	29.24.02
# 1 - 3,5 mm	# 2 - 5,5 mm
	
17 cm – 6¾"	17 cm – 6¾"
29.24.51	29.24.52



Bruns

# 000	# 00	# 0	# 1	# 2
				
17 cm – 6¾"	17 cm – 6¾"	17 cm – 6¾"	17 cm – 6¾"	17 cm – 6¾"
29.40.33	29.40.42	29.40.50	29.40.51	29.40.52
# 3	# 4	# 5	# 6	
				
17 cm – 6¾"	17 cm – 6¾"	17 cm – 6¾"	17 cm – 6¾"	
29.40.53	29.40.54	29.40.55	29.40.56	



Scharfe Löffel
Sharp Curettes
Cucharillas cortantes
Curettes tranchantes
Cucchiai taglienti

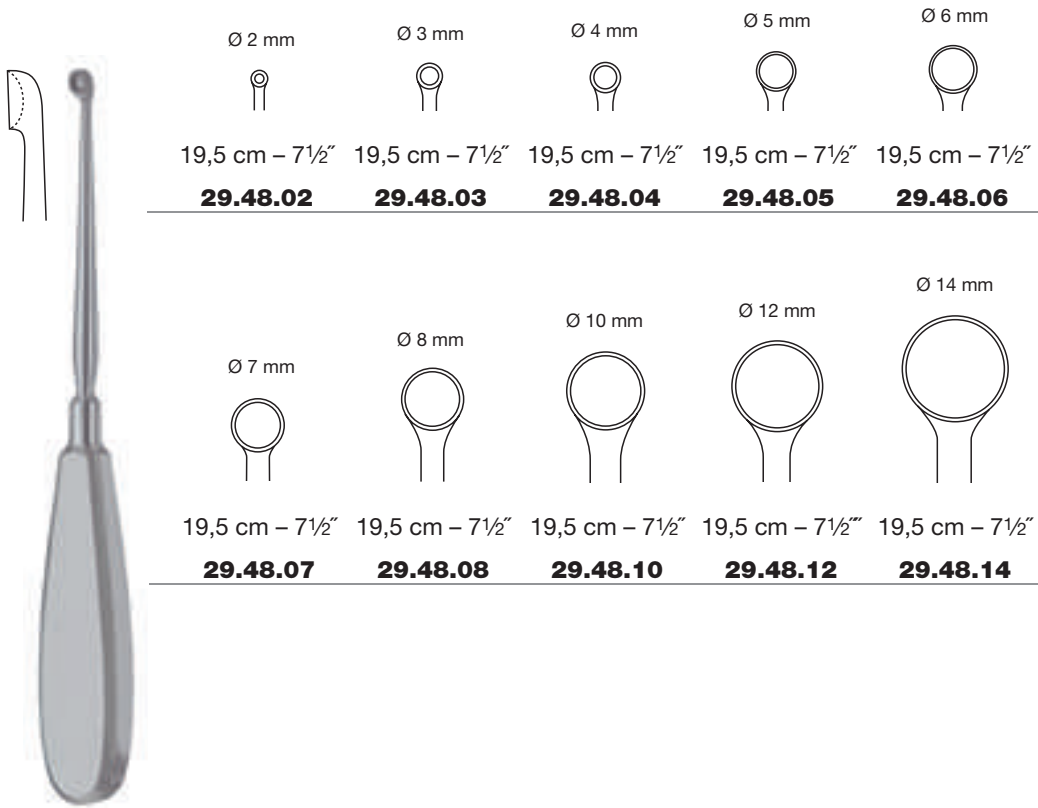

Ø 2 mm



19,5 cm – 7½"

29.48.02

Ø 3 mm



19,5 cm – 7½"

29.48.03

Ø 4 mm



19,5 cm – 7½"

29.48.04

Ø 5 mm



19,5 cm – 7½"

29.48.05

Ø 6 mm



19,5 cm – 7½"

29.48.06

Ø 7 mm



19,5 cm – 7½"

29.48.07

Ø 8 mm



19,5 cm – 7½"

29.48.08

Ø 10 mm



19,5 cm – 7½"

29.48.10

Ø 12 mm



19,5 cm – 7½"

29.48.12

Ø 14 mm

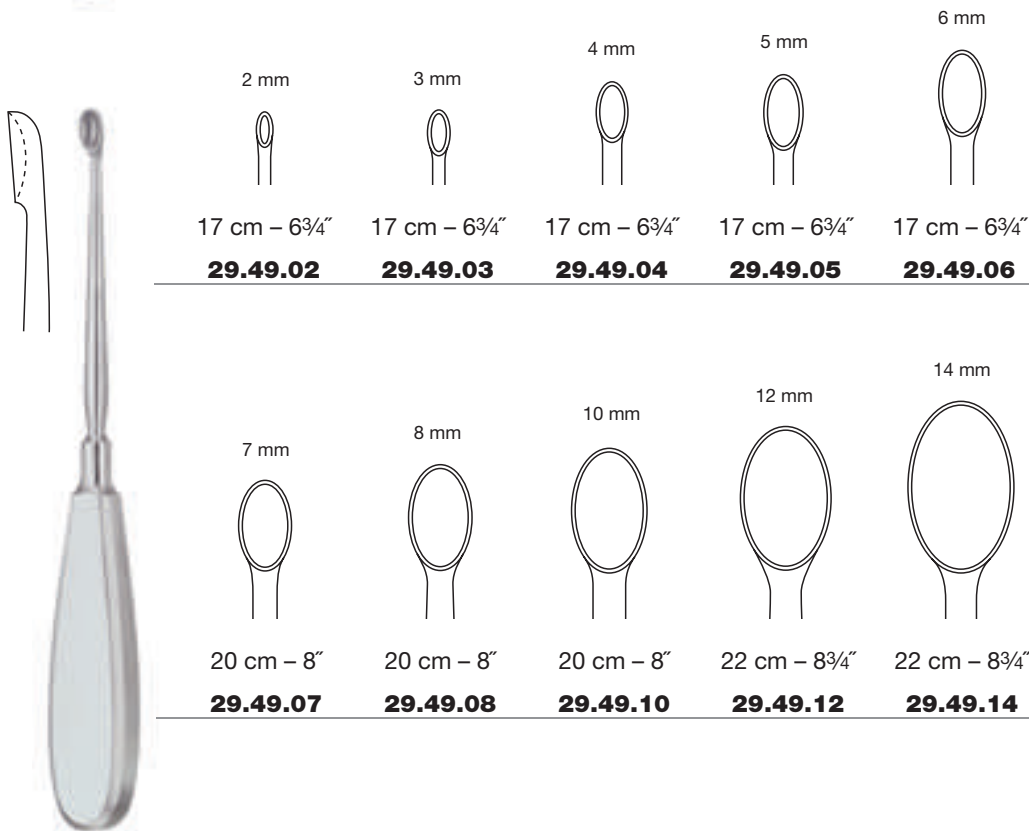

19,5 cm – 7½"

29.48.14

2 mm



17 cm – 6¾"

29.49.02

3 mm



17 cm – 6¾"

29.49.03

4 mm



17 cm – 6¾"

29.49.04

5 mm



17 cm – 6¾"

29.49.05

6 mm



17 cm – 6¾"

29.49.06

7 mm



20 cm – 8"

29.49.07

8 mm



20 cm – 8"

29.49.08

10 mm



20 cm – 8"

29.49.10

12 mm



22 cm – 8¾"

29.49.12

14 mm



22 cm – 8¾"

29.49.14



Scharfe Löffel
Sharp Curettes
Cucharillas cortantes
Curettes tranchantes
Cucchiai taglienti



Volkmann

# 0000	# 000	# 00	# 0	# 1
17 cm - 6¾"	17 cm - 6¾"	17 cm - 6¾"	17 cm - 6¾"	17 cm - 6¾"
29.51.24	29.51.33	29.51.42	29.51.50	29.51.51
# 2	# 3	# 4	# 5	# 6
17 cm - 6¾"	17 cm - 6¾"	17 cm - 6¾"	17 cm - 6¾"	17 cm - 6¾"
29.51.52	29.51.53	29.51.54	29.51.55	29.51.56



Schede

# 000	# 00	# 0	# 1
17 cm - 6¾"	17 cm - 6¾"	17 cm - 6¾"	17 cm - 6¾"
29.52.33	29.52.42	29.52.50	29.52.51
# 2	# 3	# 4	
17 cm - 6¾"	17 cm - 6¾"	17 cm - 6¾"	
29.52.52	29.52.53	29.52.54	



Scharfe Löffel
Sharp Curettes
Cucharillas cortantes
Curettes tranchantes
Cucchiai taglienti



Volkmann

0000



22 cm - 8 3/4"

29.53.24

000



22 cm - 8 3/4"

29.53.33

00



22 cm - 8 3/4"

29.53.42

0



22 cm - 8 3/4"

29.53.50

1



22 cm - 8 3/4"

29.53.51

2



22 cm - 8 3/4"

29.53.52

3



22 cm - 8 3/4"

29.53.53

4



22 cm - 8 3/4"

29.53.54

5



22 cm - 8 3/4"

29.53.55

6



22 cm - 8 3/4"

29.53.56

0000



22 cm - 8 3/4"

29.53.64

000



22 cm - 8 3/4"

29.53.73

00



22 cm - 8 3/4"

29.53.82

0



22 cm - 8 3/4"

29.53.90

1



22 cm - 8 3/4"

29.53.91

2



22 cm - 8 3/4"

29.53.92

3



22 cm - 8 3/4"

29.53.93

4



22 cm - 8 3/4"

29.53.94

5



22 cm - 8 3/4"

29.53.95

6



22 cm - 8 3/4"

29.53.96



Volkmann



Scharfe Löffel
Sharp Curettes
Cucharillas cortantes
Curettes tranchantes
Cucchiai taglienti



Bruns

# 0000	# 000	# 00	# 0	# 1
23 cm - 9"	23 cm - 9"	23 cm - 9"	23 cm - 9"	23 cm - 9"
29.55.24	29.55.33	29.55.42	29.55.50	29.55.51
# 2	# 3	# 4	# 5	# 6
23 cm - 9"	23 cm - 9"	23 cm - 9"	23 cm - 9"	23 cm - 9"
29.55.52	29.55.53	29.55.54	29.55.55	29.55.56



Bruns

# 0000	# 000	# 00	# 0	# 1
27 cm - 10 ³ / ₄ "	27 cm - 10 ³ / ₄ "	27 cm - 10 ³ / ₄ "	27 cm - 10 ³ / ₄ "	27 cm - 10 ³ / ₄ "
29.56.24	29.56.33	29.56.42	29.56.50	29.56.51
29.56.24P	29.56.33P	29.56.42P	29.56.50P	29.56.51P
# 2	# 3	# 4	# 5	# 6
27 cm - 10 ³ / ₄ "	27 cm - 10 ³ / ₄ "	27 cm - 10 ³ / ₄ "	27 cm - 10 ³ / ₄ "	27 cm - 10 ³ / ₄ "
29.56.52	29.56.53	29.56.54	29.56.55	29.56.56
29.56.52P	29.56.53P	29.56.54P	29.56.55P	29.56.56P



Kunststoffgriff (autoklavierbar bis 134 °C bei 3 bar)
 Plastic handle (autoclavable up to 134 °C at 3 bar)
 Mango de plástico (autoclavable hasta 134 °C bajo presión de 3 bar)
 Manche en plastique (autoclavable à 134 °C sous pression de 3 bars)
 Manico di plastica (autoclavabile fino a 134 °C sotto pressione di 3 bar)



Scharfe Löffel
Sharp Curettes
Cucharillas cortantes
Curettes tranchantes
Cucchiai taglienti

	# 000	# 00	# 0
	18 cm – 7 1/8"	18 cm – 7 1/8"	18 cm – 7 1/8"
	29.63.33	29.63.42	29.63.50

	# 1	# 2
	18 cm – 7 1/8"	18 cm – 7 1/8"
	29.63.51	29.63.52



Spratt

	21 cm – 8 1/4"	21 cm – 8 1/4"	21 cm – 8 1/4"	21 cm – 8 1/4"
	29.67.06	29.67.15	29.67.24	29.67.33
	# 000000	# 00000	# 0000	# 000



Lempert

	4 mm	5 mm	6 mm
	21 cm – 8 1/4"	21 cm – 8 1/4"	21 cm – 8 1/4"
	29.69.51	29.69.52	29.69.53
	# 1	# 2	# 3

	21 cm – 8 1/4"	21 cm – 8 1/4"	21 cm – 8 1/4"	21 cm – 8 1/4"
	29.67.42	29.67.50	29.67.51	29.67.52
	# 00	# 0	# 1	# 2



Halle



biegbar
malleable
maleables
malléables
malleabili



Scharfe Löffel
Sharp Curettes
Cucharillas cortantes
Curettes tranchantes
Cucchiai taglienti

14 cm – 5 1/2" 14 cm – 5 1/2" 14 cm – 5 1/2"

29.80.10 **29.80.11** **29.80.12**

00-0 # 0-1 # 1-2

Martini

Ø 3 mm

17 cm – 6 3/4"

29.80.62

Ø 5 mm

Jansen

14 cm – 5 1/2" 14 cm – 5 1/2" 14 cm – 5 1/2"

29.83.10 **29.83.11** **29.83.12**

00-0 # 0-1 # 1-2

Williger

3 mm

16 cm – 6 1/4"

29.83.62

3 mm

Williger



Scharfe Löffel
Sharp Curettes
Cucharillas cortantes
Curettes tranchantes
Cucchiai taglienti

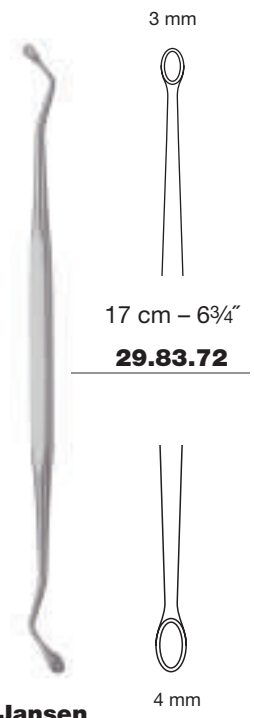
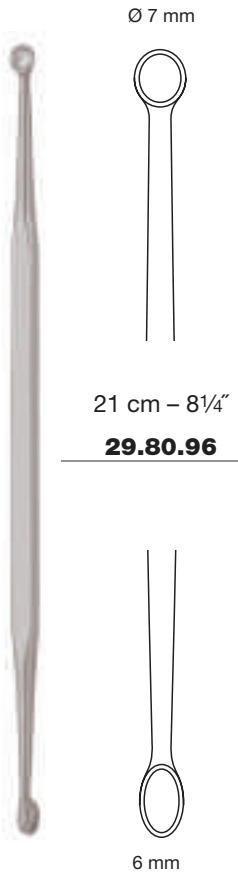

Jansen

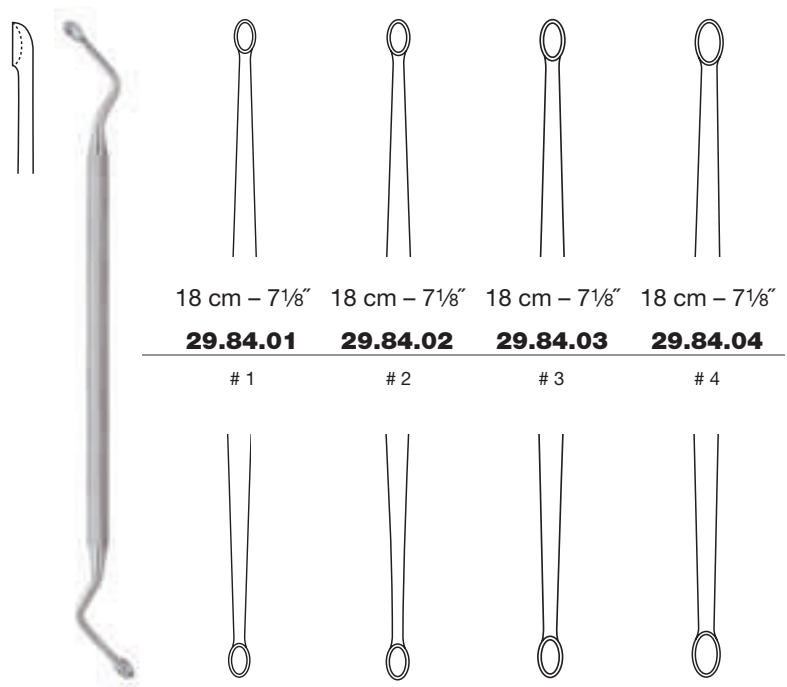

Hemingway



Scharfe Löffel
Sharp Curettes
Cucharillas cortantes
Curettes tranchantes
Cucchiai taglienti



13,0 cm – 5 1/8"

29.85.13

14,5 cm – 5 3/4"

29.85.14

Volkman

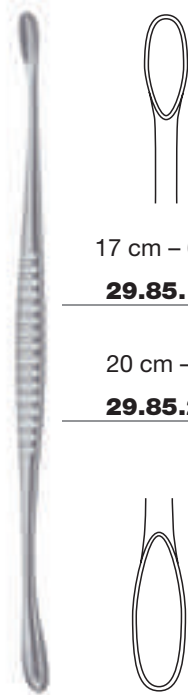

17 cm – 6 3/4"

29.85.17

20 cm – 8"

29.85.20

Volkman



Volkman

3 mm

4 mm

5 mm



22 cm – 8 3/4"

22 cm – 8 3/4"

22 cm – 8 3/4"

29.87.01

29.87.02

29.87.03

1

2

3



5 mm

6 mm

7 mm



Hohlmeißelzangen
Bone Rongeurs
Pinzas gubias
Pinces-gouges
Pinze sgorbie



14 cm – 5½"
30.05.14

Friedmann

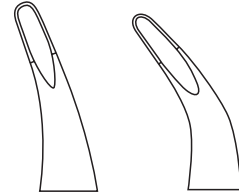

14 cm – 5½" 14 cm – 5½"
30.07.14 30.07.15



14 cm – 5½" 17 cm – 6¾"
30.15.14 30.15.17
4 # 4A

Mead

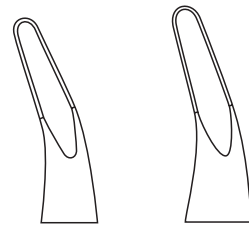

14 cm – 5½" 17 cm – 6¾"
30.17.14 30.17.17
1 # 1A

Mead



Hohlmeißelzangen
Bone Rongeurs
Pinzas gubias
Pinces-gouges
Pinze sgorbie

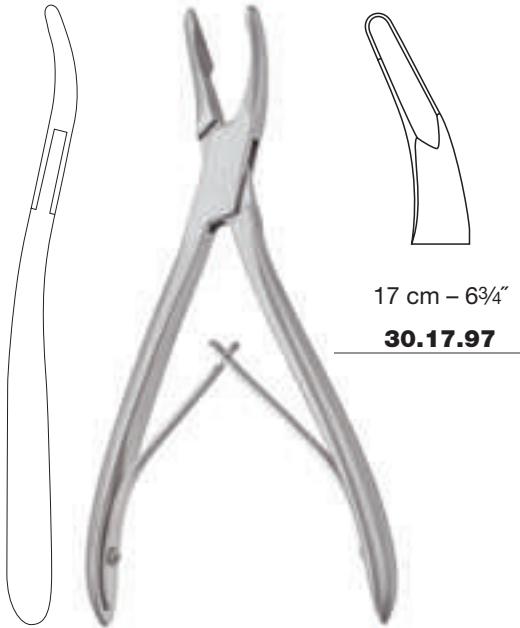

Schell

17 cm – 6¾"
30.17.97

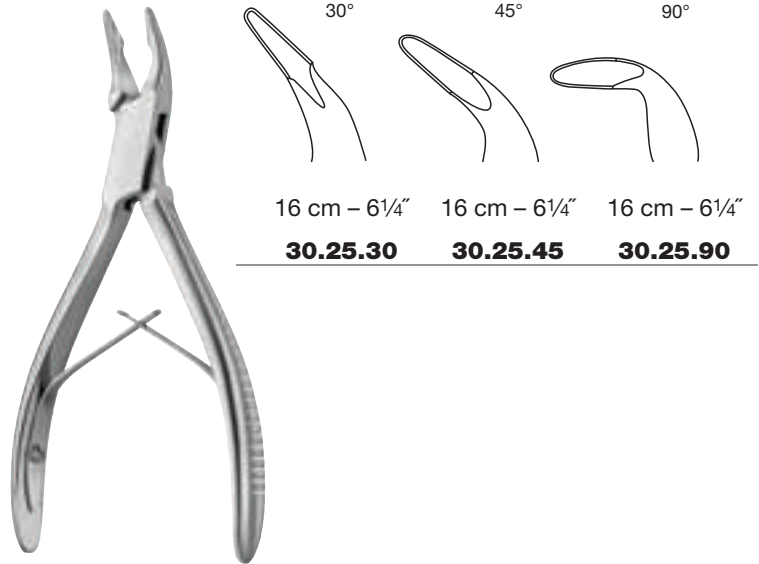

Blumenthal

30°	45°	90°
16 cm – 6¼"	16 cm – 6¼"	16 cm – 6¼"
30.25.30	30.25.45	30.25.90

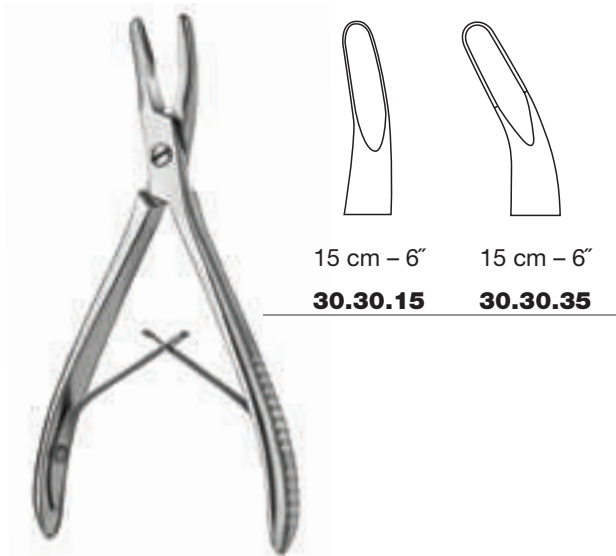

Luer

15 cm – 6"	15 cm – 6"
30.30.15	30.30.35



Bane

18 cm – 7⅛"
30.38.18



Hohlmeißelzangen
Bone Rongeurs
Pinzas gubias
Pinces-gouges
Pinze sgorbie



16 cm – 6¼"
30.38.56

Hartmann



20 cm – 8"
30.38.69

Olivecrona

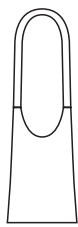
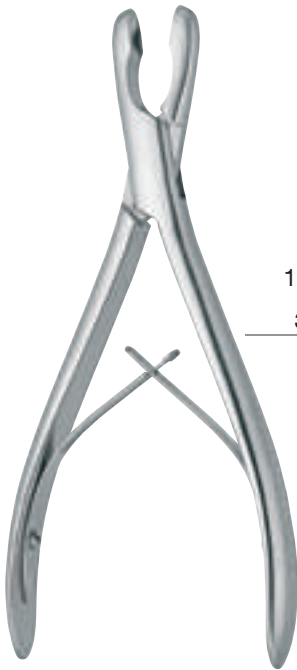

18 cm – 7⅛"
30.52.17

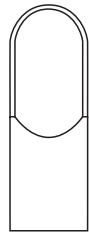

18 cm – 7⅛"
30.52.18

Luer



18 cm – 7⅛"
30.53.17

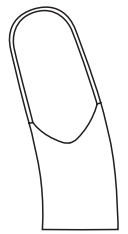

18 cm – 7⅛"
30.53.18

Luer



Hohlmeißelzangen
Bone Rongeurs
Pinzas gubias
Pinces-gouges
Pinze sgorbie



Jansen

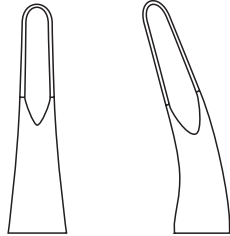

17 cm – 6¾" 17 cm – 6¾"
30.50.18 30.51.18



Adson



21 cm – 8¼"
30.54.21



Beyer

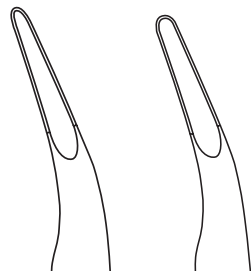

17 cm – 6¾" 17 cm – 6¾"
30.71.02 30.71.03

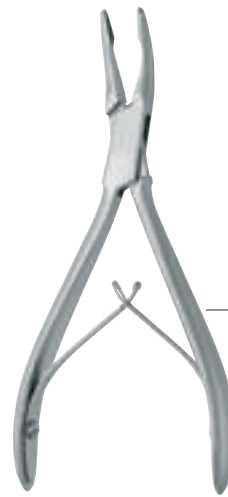

Kleinert-Kutz

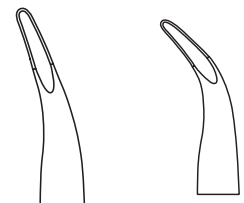

14 cm – 5½" 14 cm – 5½"
30.76.13 30.76.14



Hohlmeißelzangen
Bone Rongeurs
Pinzas gubias
Pinces-gouges
Pinze sgorbie



20 cm – 8"
30.54.70

Bacon

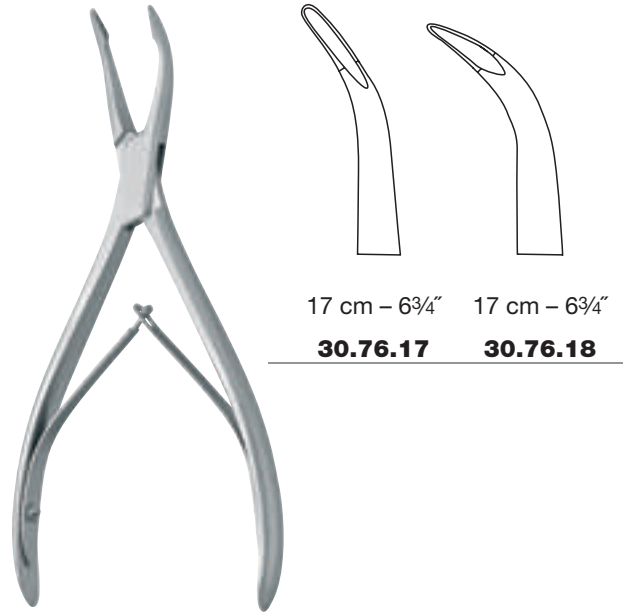

17 cm – 6¾" 17 cm – 6¾"
30.76.17 30.76.18

Stellbrink



19 cm – 7½"
30.79.19

Defourmentel

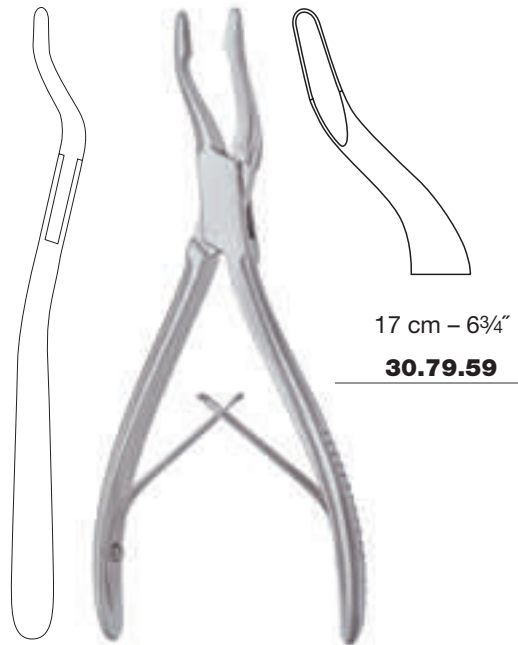

17 cm – 6¾"
30.79.59

Jansen



Hohlmeißelzangen
Bone Rongeurs
Pinzas gubias
Pinces-gouges
Pinze sgorbie

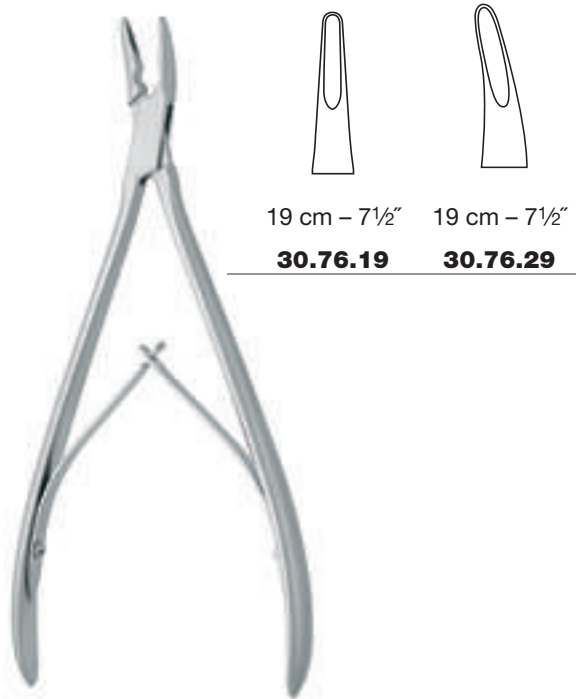

19 cm - 7 1/2" 19 cm - 7 1/2"
30.76.19 30.76.29

Lempert



15 cm - 6" 15 cm - 6"
31.04.02 31.04.03

Ruskin-Mini



15 cm - 6" 15 cm - 6"
31.05.02 31.05.03

Ruskin-Mini



15 cm - 6"
31.05.53

Kleinert-Kutz



Hohlmeißelzangen
Bone Rongeurs
Pinzas gubias
Pinces-gouges
Pinze sgorbie



15 cm – 6"
31.05.83

Geiger

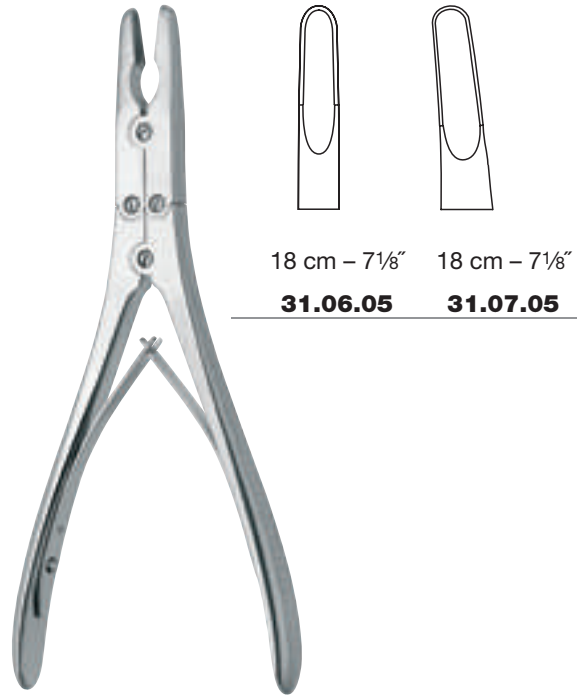

18 cm – 7 1/8" 18 cm – 7 1/8"
31.06.05 31.07.05

Ruskin

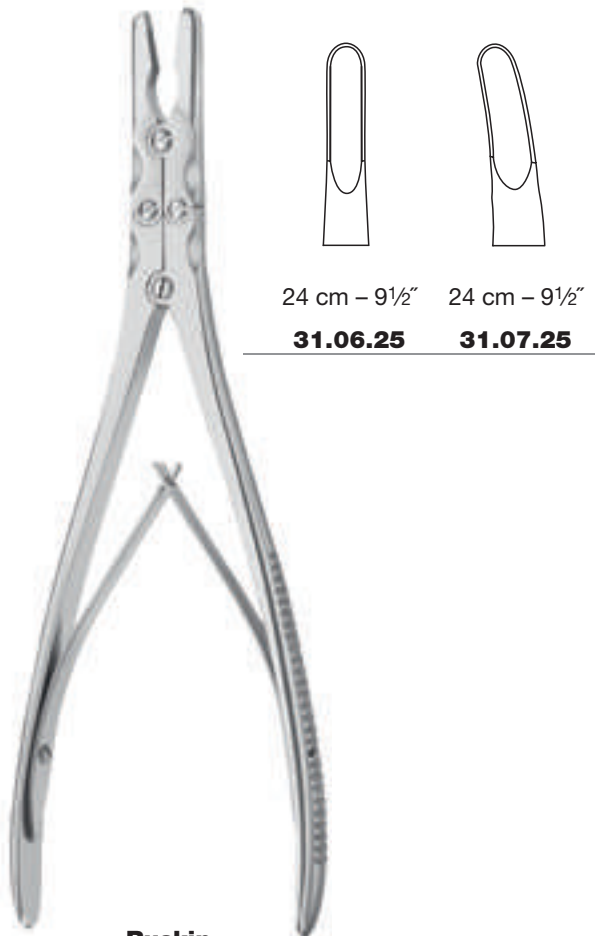

24 cm – 9 1/2" 24 cm – 9 1/2"
31.06.25 31.07.25

Ruskin

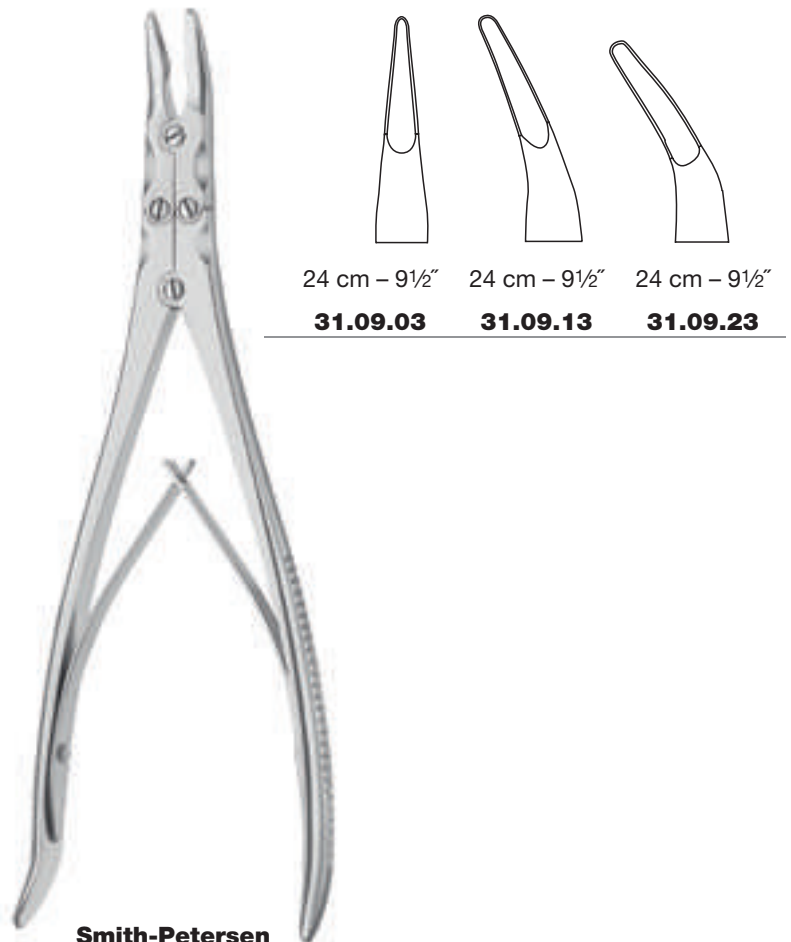

24 cm – 9 1/2" 24 cm – 9 1/2" 24 cm – 9 1/2"
31.09.03 31.09.13 31.09.23

Smith-Petersen

Hohlmeißelzangen
Bone Rongeurs
Pinzas gubias
Pinces-gouges
Pinze sgorbie



18 cm – 7 1/8"
31.07.65

Ruskin



23 cm – 9"
31.09.93

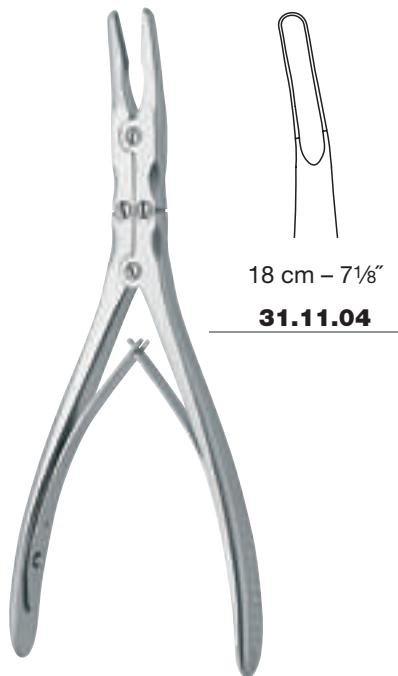

18 cm – 7 1/8"
31.11.04

Beyer



18 cm – 7 1/8"
31.11.05

Zaufal-Jansen



Hohlmeißelzangen
Bone Rongeurs
Pinzas gubias
Pinces-gouges
Pinze sgorbie



Marquardt



20 cm - 8"

31.11.13



Stille-Luer

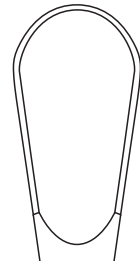

23 cm - 9"

31.30.24

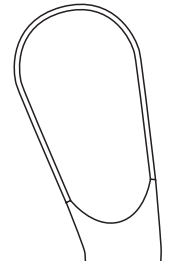

23 cm - 9"

31.31.24

27 cm - 10³/₄"

31.30.27

27 cm - 10³/₄"

31.31.27



Stille-Luer

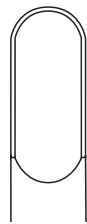

23 cm - 9"

31.30.23

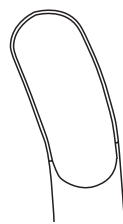

23 cm - 9"

31.31.23



Hohlmeißelzangen
Bone Rongeurs
Pinzas gubias
Pinces-gouges
Pinze sgorbie



23 cm - 9"

31.31.53

27 cm - 10³/₄"

31.31.57

Semb-Stille



23 cm - 9"

31.31.83

Stille



Hohlmeißelzangen
Bone Rongeurs
Pinzas gubias
Pinces-gouges
Pinze sgorbie



Leksell



23 cm - 9"

31.51.05



23 cm - 9"

31.51.08



Leksell



23 cm - 9"

31.53.03

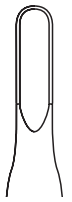

23 cm - 9"

31.53.05

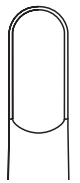

23 cm - 9"

31.53.08



Hohlmeißelzangen
Bone Rongeurs
Pinzas gubias
Pinces-gouges
Pinze sgorbie



Leksell

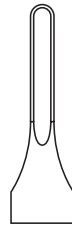

36 cm – 14 1/8"

31.54.03

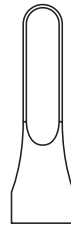

36 cm – 14 1/8"

31.54.05



36 cm – 14 1/8"

31.54.08



Echlin



23 cm – 9"

31.61.02

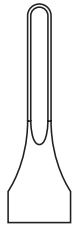

23 cm – 9"

31.61.03

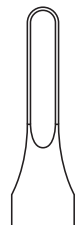

23 cm – 9"

31.61.04



Knochensplitterzangen
Bone Cutting Forceps
Pinzas cortantes para huesos
Pinces coupantes à os
Pinze ossivore

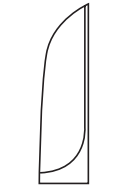
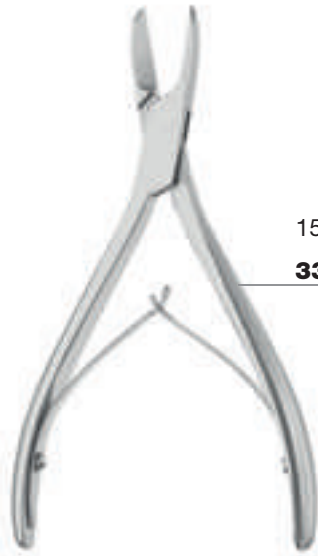

15 cm - 6"

33.02.15

Littauer-Liston



18 cm - 7 1/8"

33.04.18

Cottle-Kazanjan



14 cm - 5 1/2"

33.11.14

Niro



17 cm - 6 3/4"

33.11.17

Cleveland

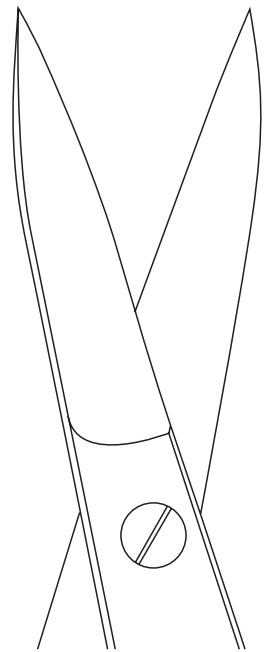

23 cm - 9"

33.20.83



Knochensplitterzangen
Bone Cutting Forceps
Pinzas cortantes para huesos
Pinces coupantes à os
Pinze ossivore



Liston



14 cm – 5½"

33.20.14



17 cm – 6¾"

33.20.17



20 cm – 8"

33.20.19



22 cm – 8¾"

33.20.22



Liston-mini



15 cm – 6"

33.50.15



15 cm – 6"

33.51.15



Liston



14 cm – 5½"

33.21.14



17 cm – 6¾"

33.21.17



20 cm – 8"

33.21.19



22 cm – 8¾"

33.21.22



Knochensplitterzangen
Bone Cutting Forceps
Pinzas cortantes para huesos
Pinces coupantes à os
Pinze ossivore

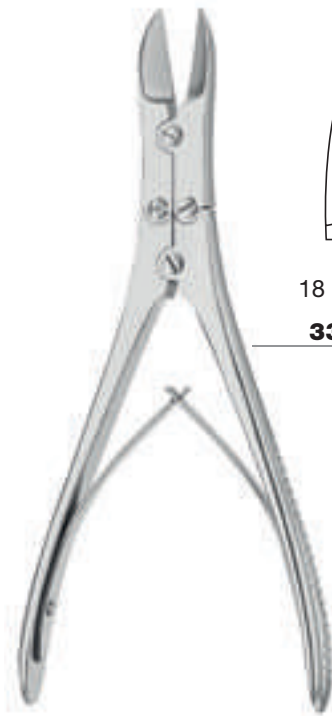

18 cm - 7 1/8"

18 cm - 7 1/8"

33.56.18

33.57.18

Ruskin-Liston

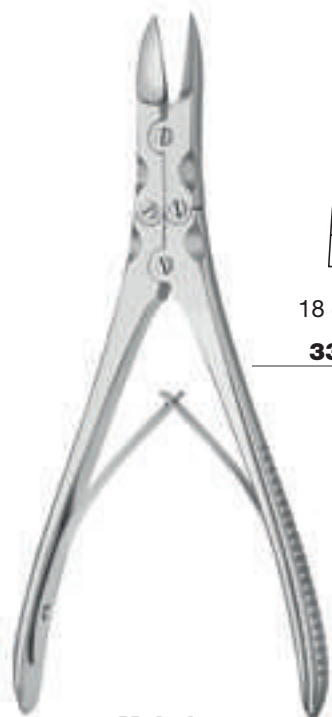

18 cm - 7 1/8"

18 cm - 7 1/8"

33.58.18

33.59.18

McIndoe



17 cm - 6 3/4"

33.59.17

McIndoe



Knochensplitterzangen
Bone Cutting Forceps
Pinzas cortantes para huesos
Pinces coupantes à os
Pinze ossivore



Liston-Stille



28 cm – 11"

33.70.27

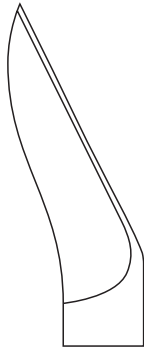

28 cm – 11"

33.71.27



Liston-Key

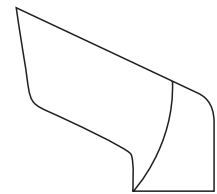

26 cm – 10¼"

33.75.27



Knochenhalte­zangen
Bone Holding Forceps
Pinzas prensoras de huesos
Daviers à os
Tenaglie per ossa

Sequesterzangen
Sequestrum forceps
Pinzas para secuestrectomía
Pinces à séquestre
Pinze per sequestri

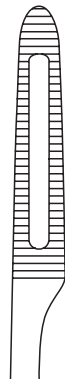

20 cm – 8"

35.02.20

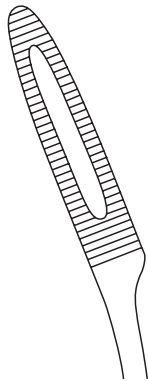

20 cm – 8"

35.03.20



Van Buren

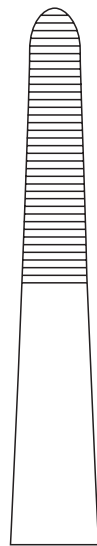

23 cm – 9"

35.05.23

Knochenhaltezangen
Bone Holding Forceps
Pinzas prensoras de huesos
Daviers à os
Tenaglie per ossa

Repositionszangen
 Reposition forceps
 Pinzas para reposición
 Pincas à reposition
 Pinze per riposizione



13,0 cm – 5 1/8"

35.11.13



14,0 cm – 5 1/2"

35.11.14

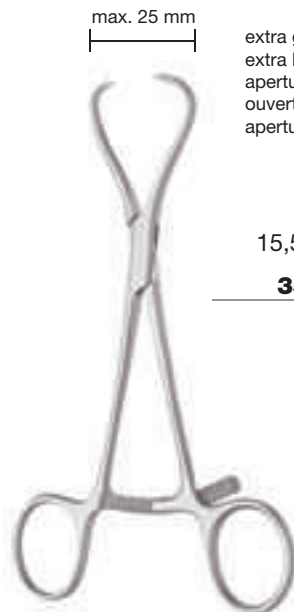

max. 25 mm

extra große Öffnung für die Handchirurgie
 extra large opening for hand surgery
 apertura grande para la cirugía de la mano
 ouverture extra-large pour la chirurgie de la main
 apertura extra grande per la chirurgia della mano

15,5 cm – 6 1/8"

35.11.17

Kistler-Manus



18 cm – 7 1/8"

35.11.18

Lewin



Knochenhaltezaugen
Bone Holding Forceps
Pinzas prensoras de huesos
Daviers à os
Tenaglie per ossa

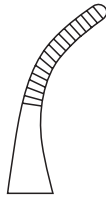
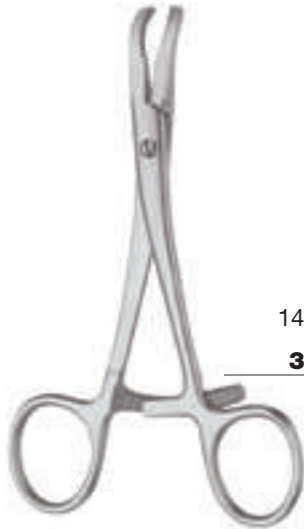

14 cm - 5½"

35.14.14

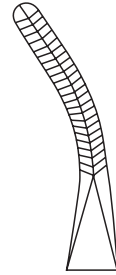

16 cm - 6¼"

35.14.16

22 cm - 8¾"

35.14.22



19 cm - 7½"

35.15.18

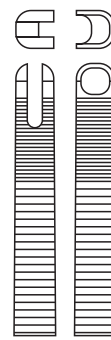

19 cm - 7½"

35.15.19

Dingman



Knochenhaltezangen
Bone Holding Forceps
Pinzas prensoras de huesos
Daviers à os
Tenaglie per ossa



21 cm – 8¼”
35.16.21



20 cm – 8”
35.20.20

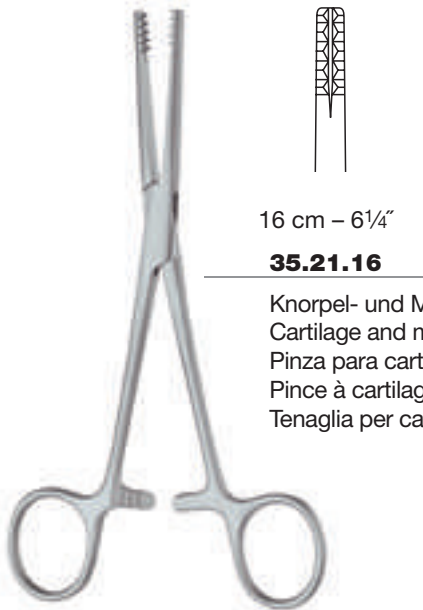

16 cm – 6¼”
35.21.16
 Knorpel- und Meniskusfasszange
 Cartilage and meniscus forceps
 Pinza para cartílagos y menisco
 Pince à cartilage et à ménisque
 Tenaglia per cartilagine e menisco

Martin



19 cm – 7½”
35.21.19
 Knorpel- und Meniskusfasszange
 Cartilage and meniscus forceps
 Pinza para cartílagos y menisco
 Pince à cartilage et à ménisque
 Tenaglia per cartilagine e menisco

Martin



Knochenhaltezangen
Bone Holding Forceps
Pinzas prensoras de huesos
Daviers à os
Tenaglie per ossa



20 cm – 8"

35.21.20

Knorpel- und Meniskusfasszange
 Cartilage and meniscus forceps
 Pinza para cartílagos y menisco
 Pince à cartilage et à ménisque
 Tenaglia per cartilagine e menisco

Bircher



21 cm – 8¼"

35.21.22

Knorpel- und Meniskusfasszange
 Cartilage and meniscus forceps
 Pinza para cartílagos y menisco
 Pince à cartilage et à ménisque
 Tenaglia per cartilagine e menisco



20 cm – 8"

35.21.25

Knorpel- und Meniskusfasszange
 Cartilage and meniscus forceps
 Pinza para cartílagos y menisco
 Pince à cartilage et à ménisque
 Tenaglia per cartilagine e menisco

Bircher-Ganske



Knochenhaltezaugen
Bone Holding Forceps
Pinzas prensoras de huesos
Daviers à os
Tenaglie per ossa

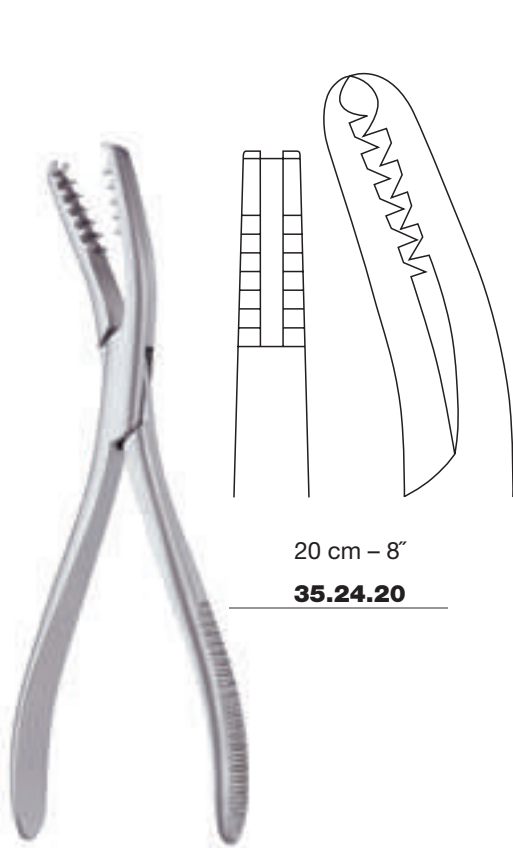

20 cm - 8"
35.24.20

Semb



20 cm - 8"
35.25.20

Semb

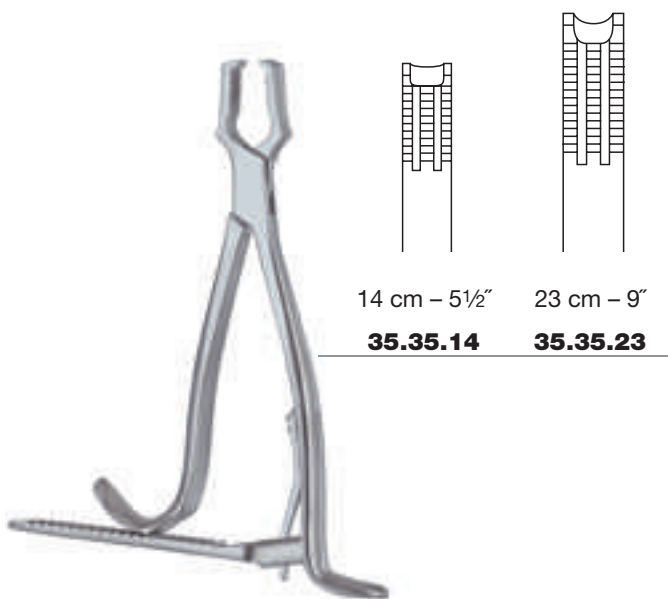

14 cm - 5½" 23 cm - 9"
35.35.14 35.35.23

Kern

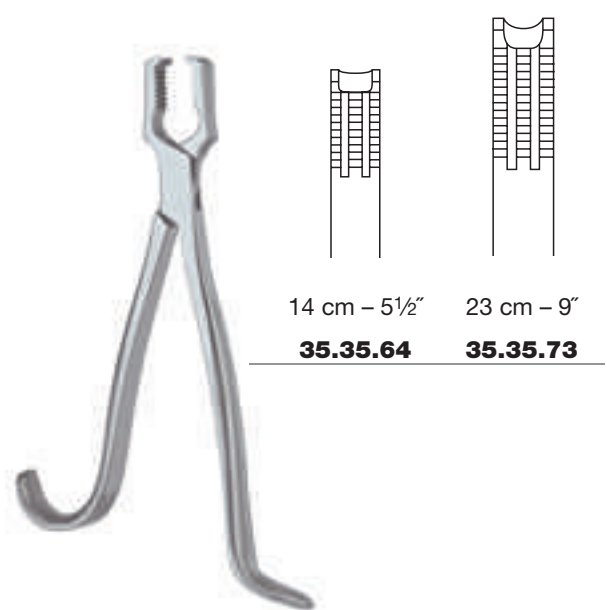

14 cm - 5½" 23 cm - 9"
35.35.64 35.35.73

Kern



Knochenhalte­zangen
Bone Holding Forceps
Pinzas prensoras de huesos
Daviers à os
Tenaglie per ossa



Ulrich

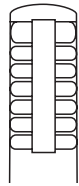

23 cm - 9"

35.45.23

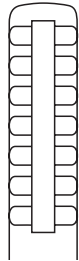

25 cm - 10"

35.45.25

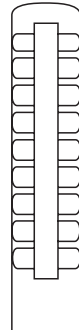

28 cm - 11"

35.45.28



Ulrich

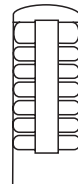

23 cm - 9"

35.45.73

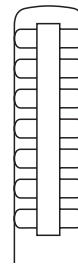

25 cm - 10"

35.45.75

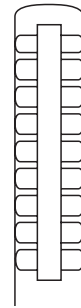

28 cm - 11"

35.45.78



Knochenhaltezaugen
Bone Holding Forceps
Pinzas prensoras de huesos
Daviers à os
Tenaglie per ossa

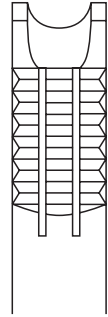
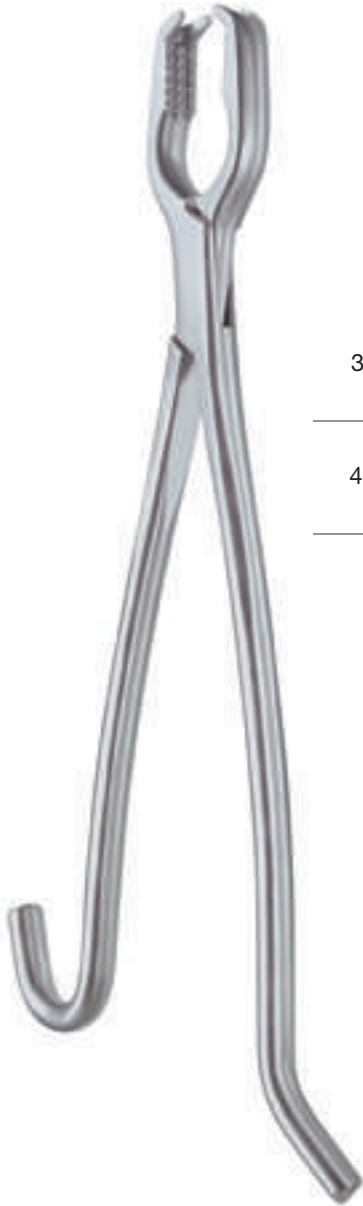

33,0 cm – 13"

35.60.33

45 cm – 17¾"

35.60.45

Lane

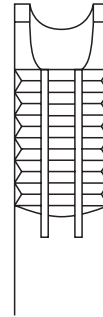
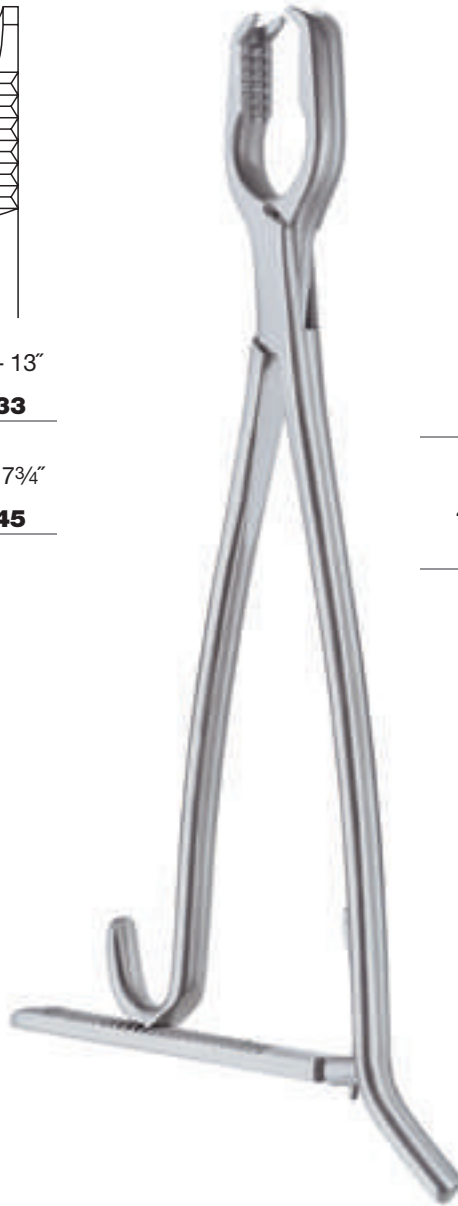

33,0 cm – 13"

35.61.33

45 cm – 17¾"

35.61.45

Lane

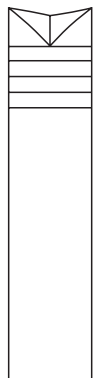

20 cm – 8"

35.50.21

Langenbeck



Knochenhaltezangen
Bone Holding Forceps
Pinzas prensoras de huesos
Daviers à os
Tenaglie per ossa



21 cm – 8¼"
35.52.21

Fergusson

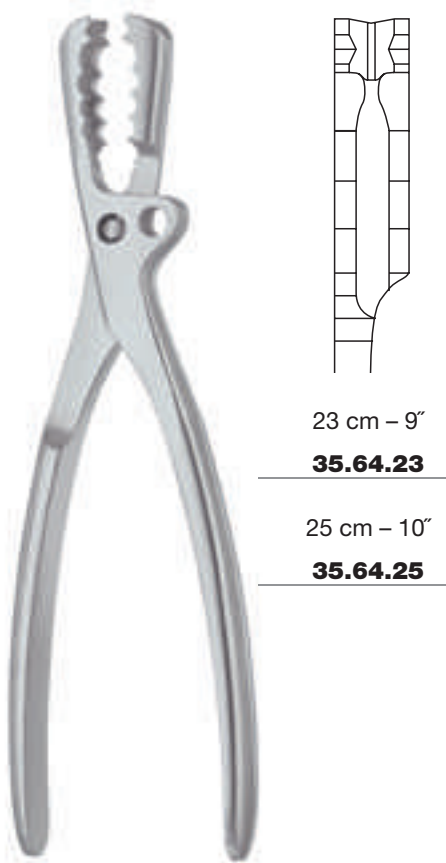

23 cm – 9"
35.64.23
25 cm – 10"
35.64.25

Farabeuf

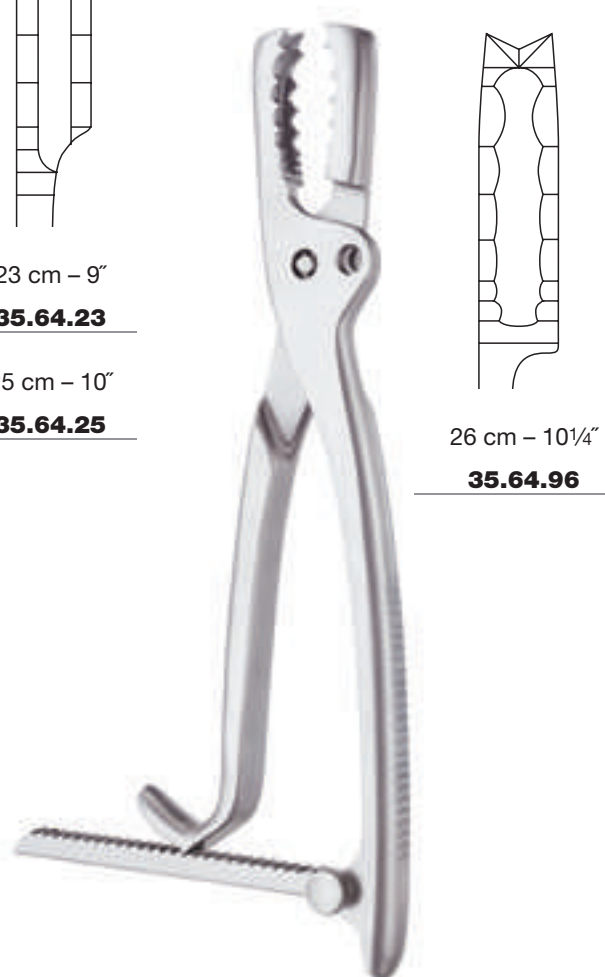

26 cm – 10¼"
35.64.96

Farabeuf-Lambotte

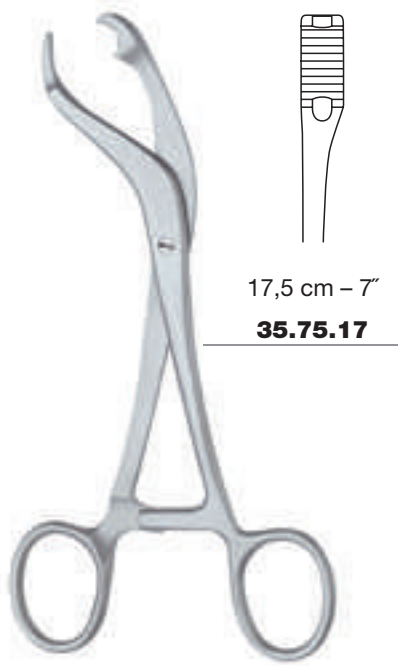

17,5 cm – 7"
35.75.17

Verbrugge

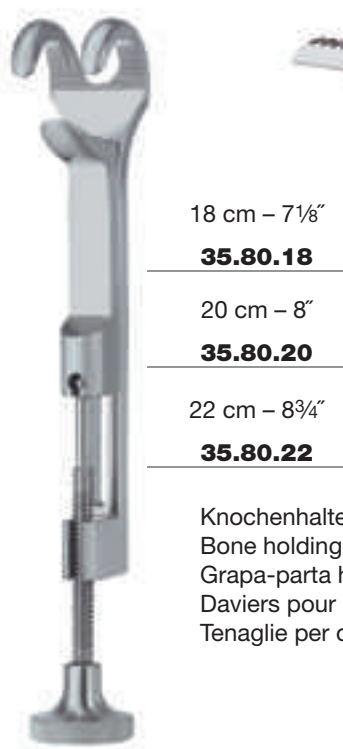

18 cm – 7⅛"
35.80.18
20 cm – 8"
35.80.20
22 cm – 8¾"
35.80.22

Lowman

Knochenhalteklammern
Bone holding clamps
Grapa-parta hueso
Daviers pour la fixation des fragments
Tenaglie per ossa

Knochenhaltezaugen
Bone Holding Forceps
Pinzas prensoras de huesos
Daviers à os
Tenaglie per ossa

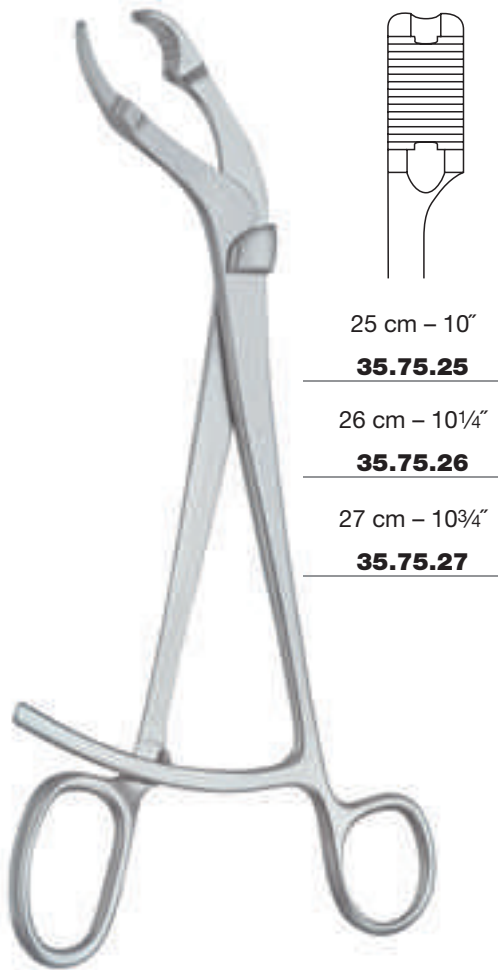

25 cm – 10"

35.75.25

26 cm – 10¼"

35.75.26

27 cm – 10¾"

35.75.27

Verbrugge



selbstzentrierend
 self-centering
 autocentrando
 autocentrer
 autocentrante

15 cm – 6"

35.76.15

19 cm – 7½"

35.76.19

24 cm – 9½"

35.76.24

26 cm – 10¼"

35.76.26

28 cm – 11"

35.76.28

Verbrugge



Reibahlen
Reamers
Escariadores
Alésoirs à main
Alesatori



17 cm – 6¾"

76.55.17

Knochenbohrer
Bone drill
Taladro para huesos
Perforateur à os
Perforatore per ossa

Championniere



15 cm – 6"

76.59.15

16 cm – 6¾"

78.03.01



21 cm – 8¼"

76.59.21



Perthes

22 cm – 8¾"

76.59.22



Perthes



Knochenhebel
Bone Levers
Elevadores para hueso
Leviers à os
Elevatori per ossa

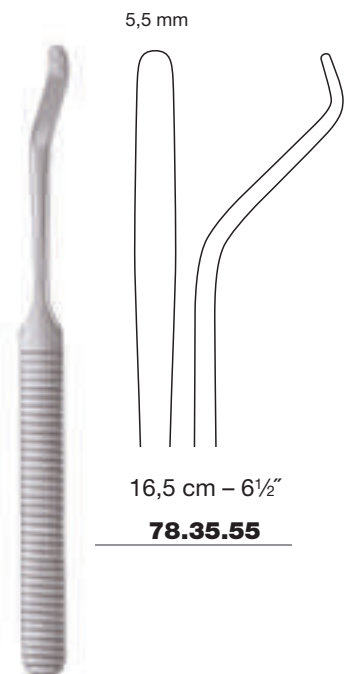
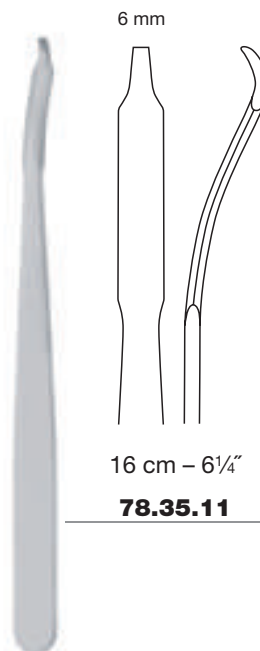
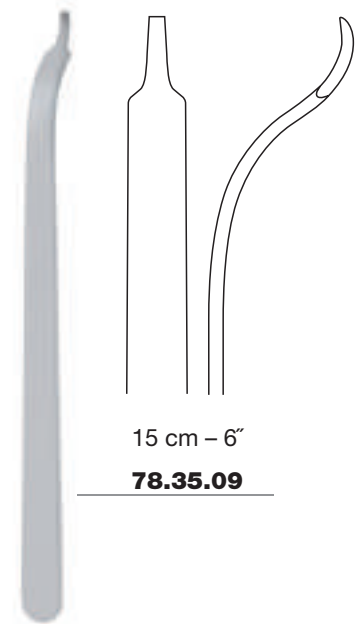
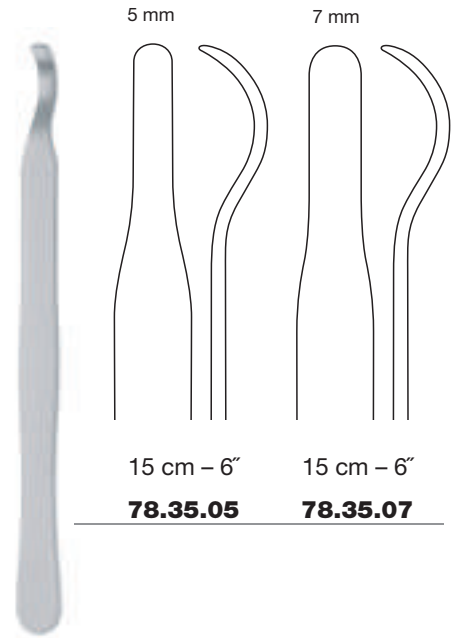

Buck-Gramcko



Knochenhebel
Bone Levers
Elevadores para hueso
Leviers à os
Elevatori per ossa

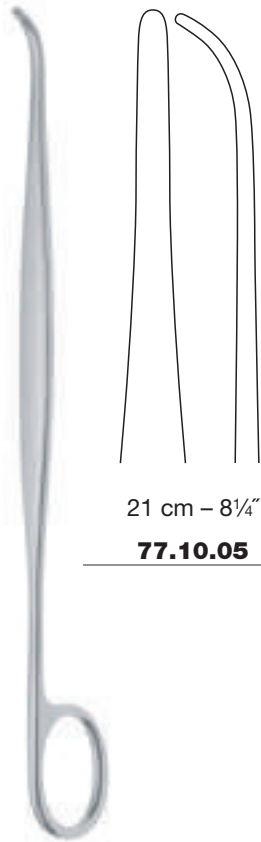

21 cm – 8¼"

77.10.05

Lane

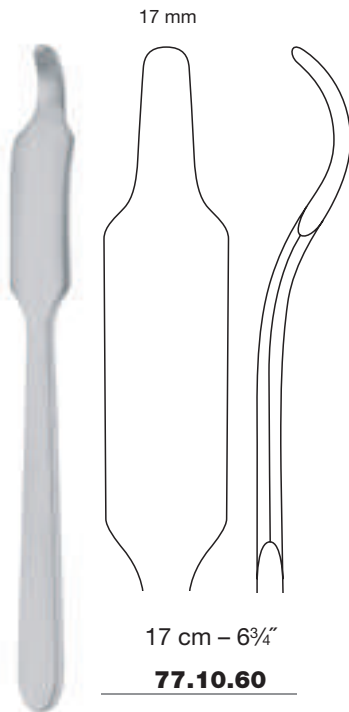

17 cm – 6¾"

77.10.60

Lange-Baby



Dingman

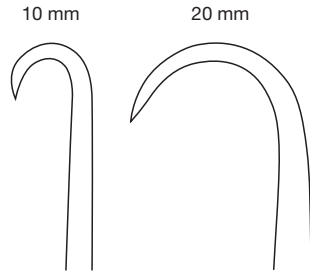

18 cm – 7½"

77.10.10

17 cm – 6¾"

77.10.20

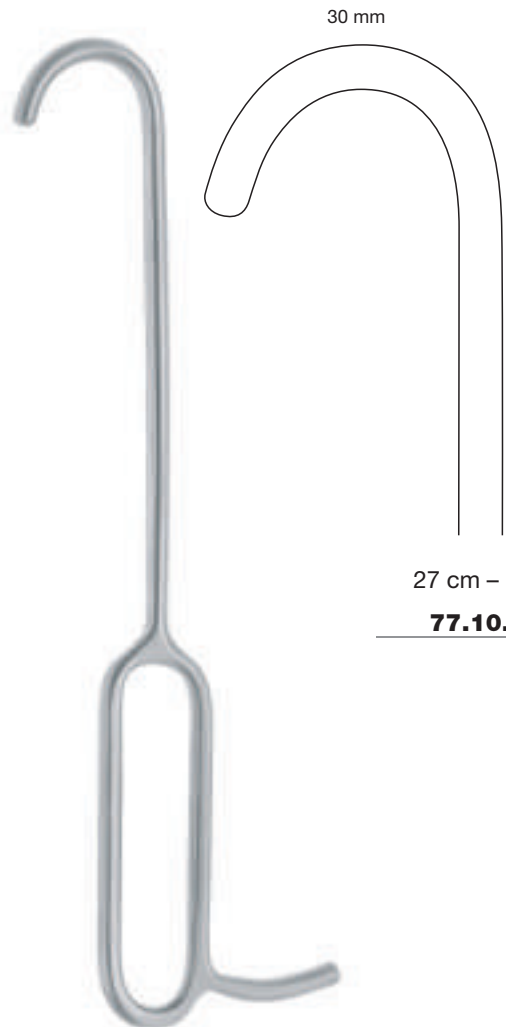

30 mm

27 cm – 10¾"

77.10.50

Lambotte



**Knochenheber
Bone Levers
Elevadores para hueso
Leviers à os
Elevatori per ossa**

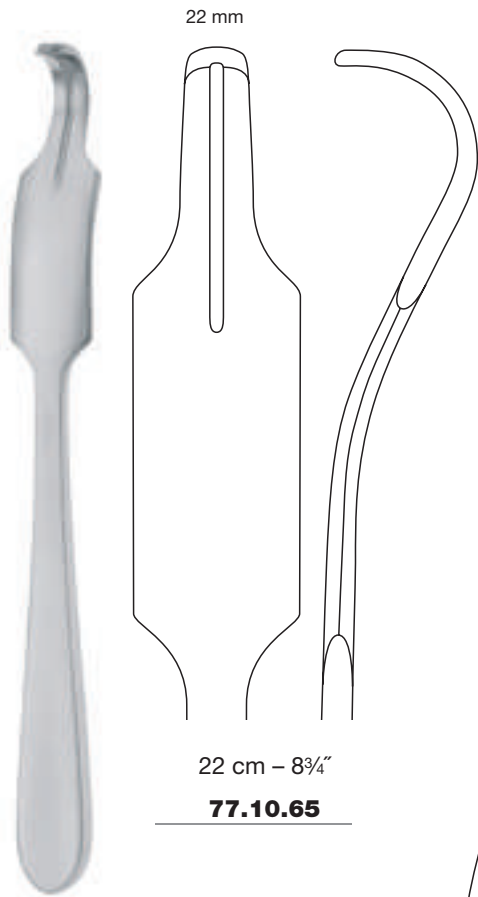

Lange

22 mm
22 cm - 8 3/4"
77.10.65

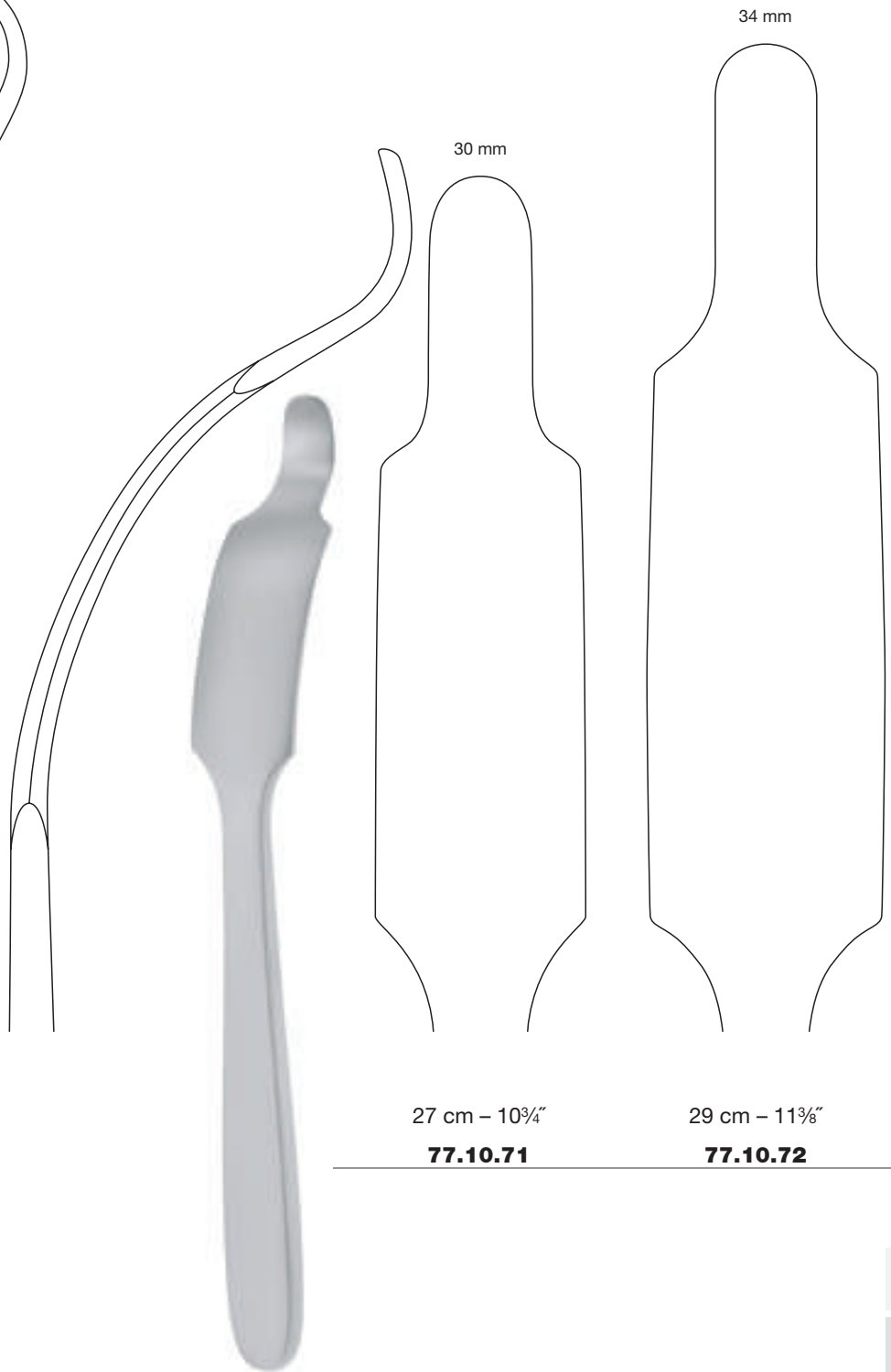

Lange-Hohmann

30 mm
27 cm - 10 3/4"
77.10.71

34 mm
29 cm - 11 1/2"
77.10.72



Knochenhebel
Bone Levers
Elevadores para hueso
Leviers à os
Elevatori per ossa

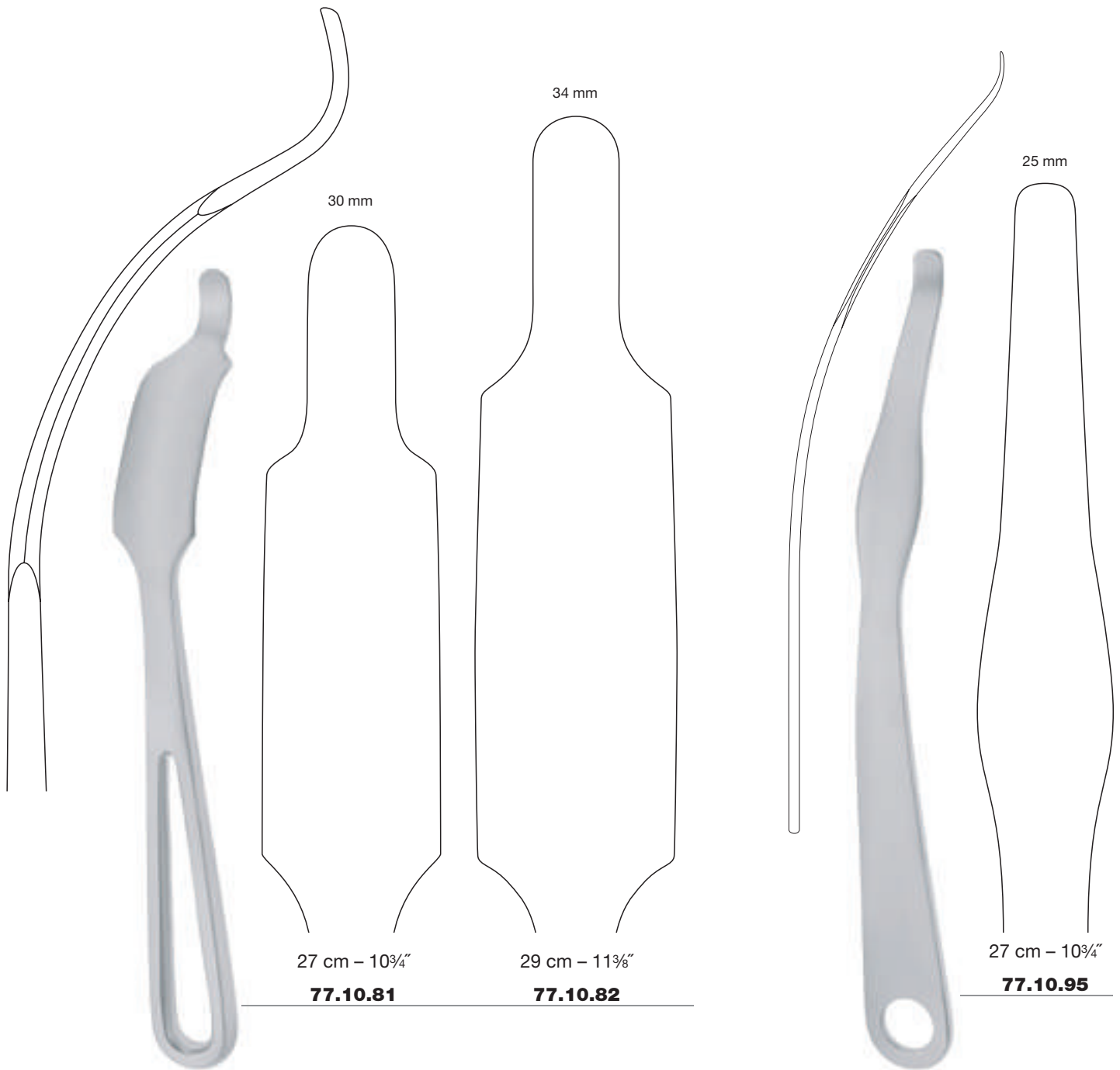

Lange-Hohmann modif.



Knochenhebel
Bone Levers
Elevadores para hueso
Leviers à os
Elevatori per ossa

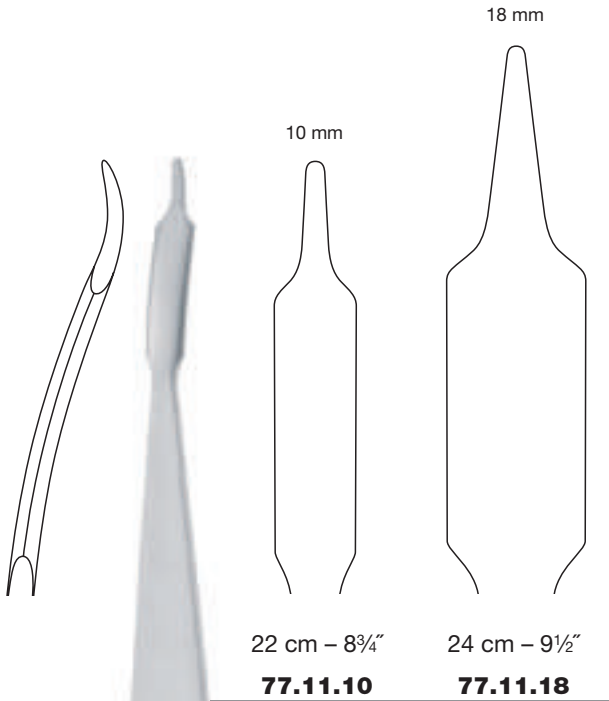

Hohmann

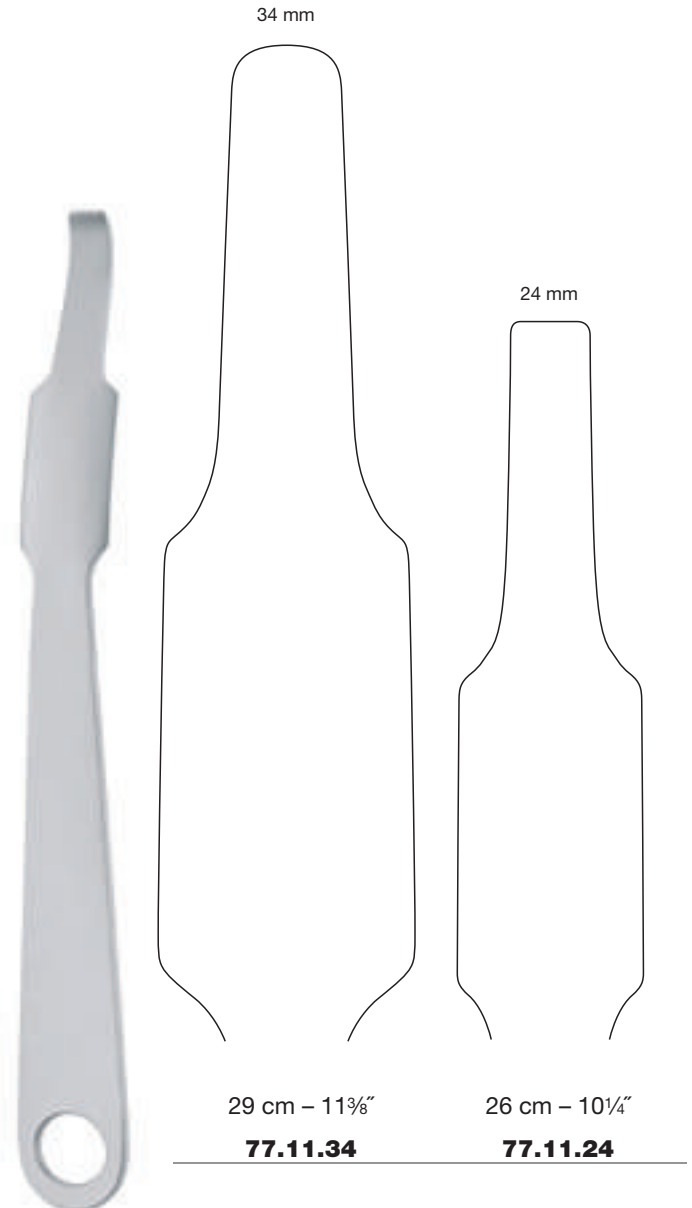
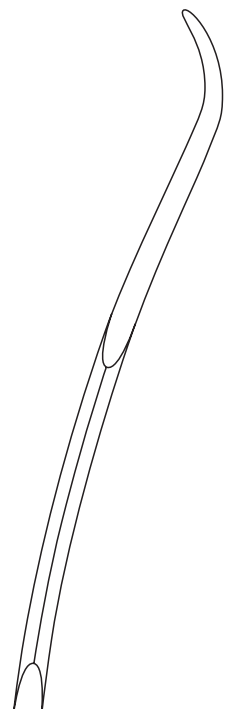

Hohmann



Knochenhebel
Bone Levers
Elevadores para hueso
Leviers à os
Elevatori per ossa

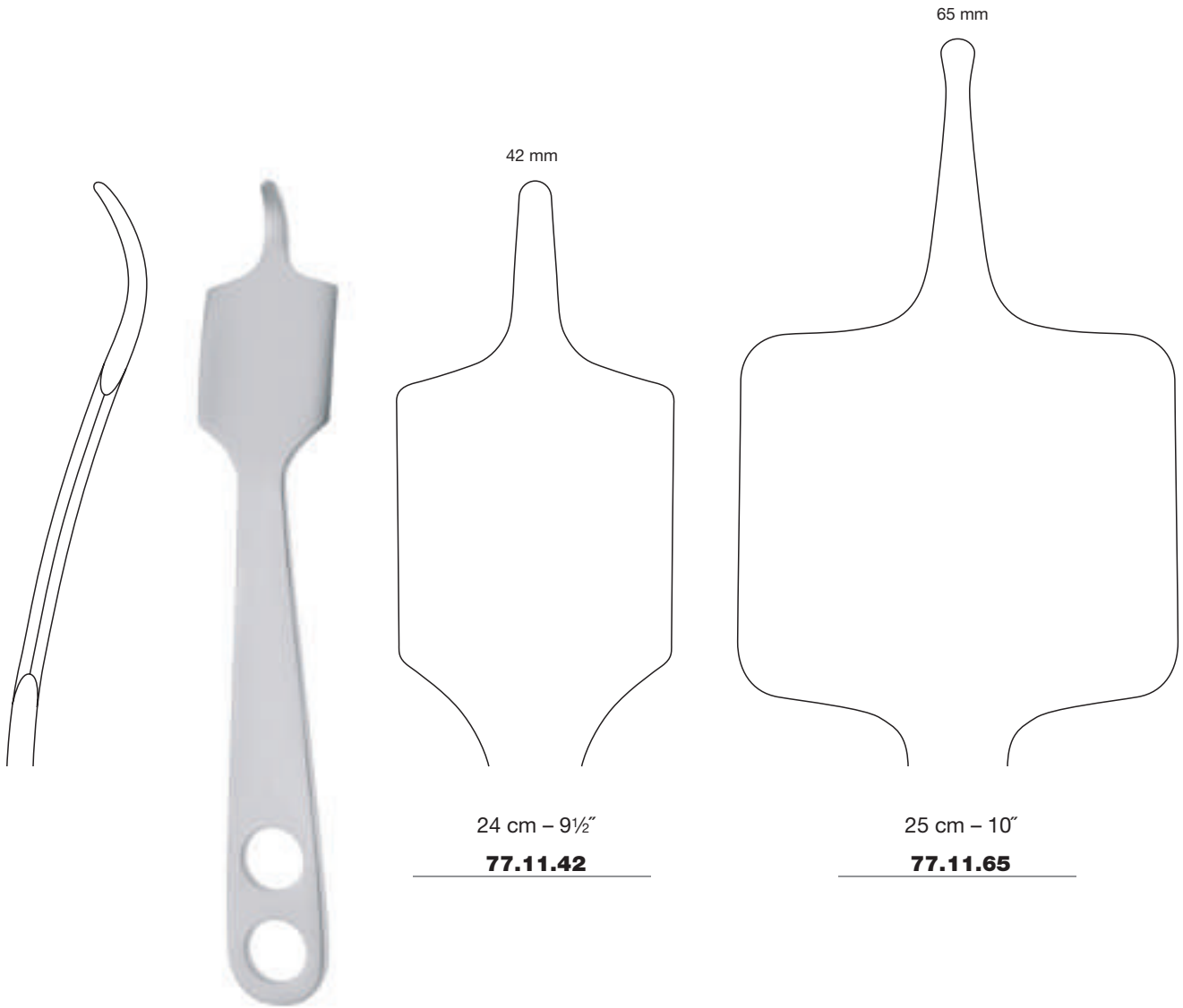

42 mm

65 mm

24 cm - 9½"

77.11.42

25 cm - 10"

77.11.65

Verbrugge-Hohmann



Knochenhebel
Bone Levers
Elevadores para hueso
Leviers à os
Elevatori per ossa

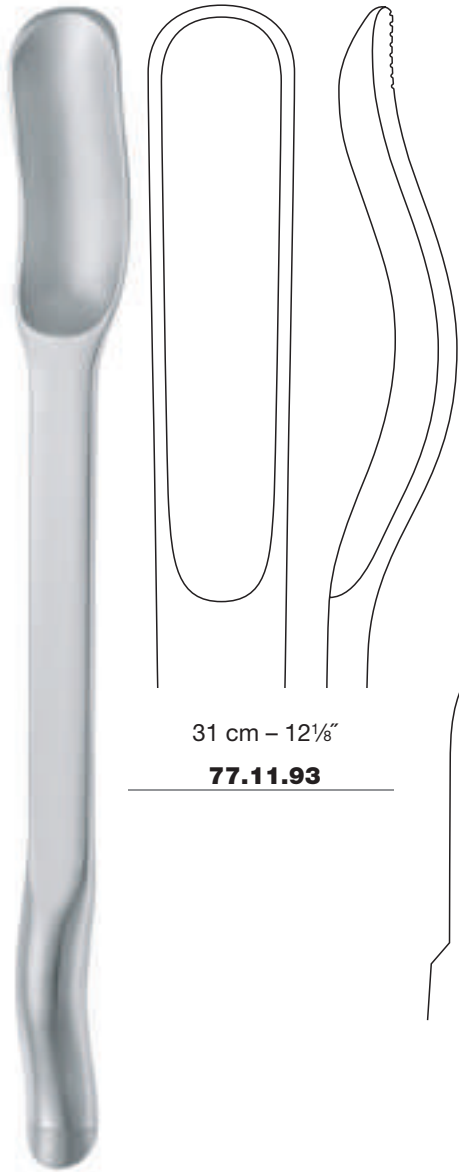

31 cm – 12¹/₈"

77.11.93

Murphy-Lane



65 mm

24 cm – 9¹/₂"

77.12.06

Bennett

45 mm

24 cm – 9¹/₂"

77.12.04



Knochenhebel
Bone Levers
Elevadores para hueso
Leviers à os
Elevatori per ossa

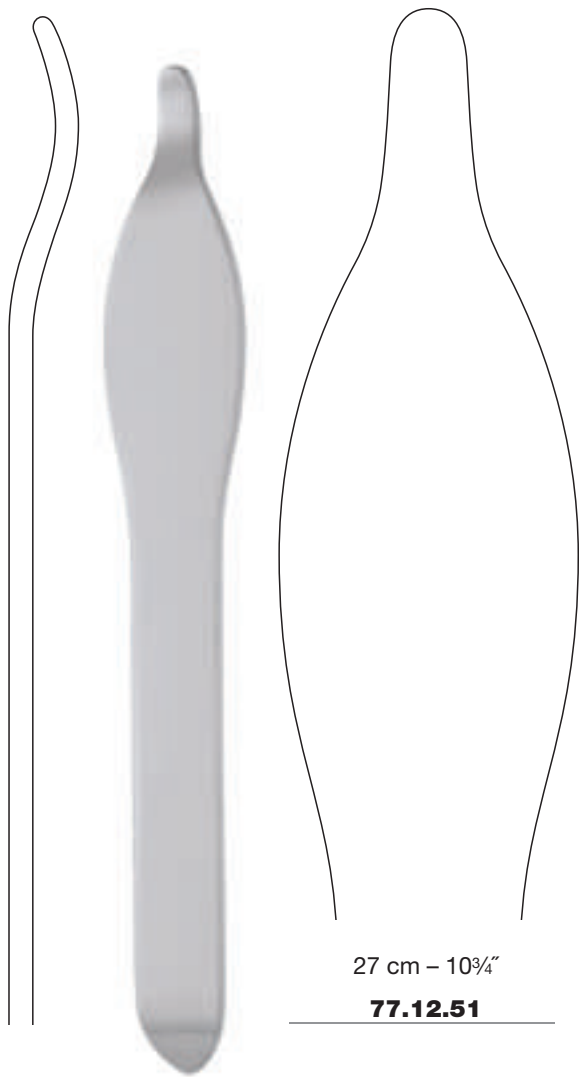

27 cm - 10 3/4"

77.12.51

Blount

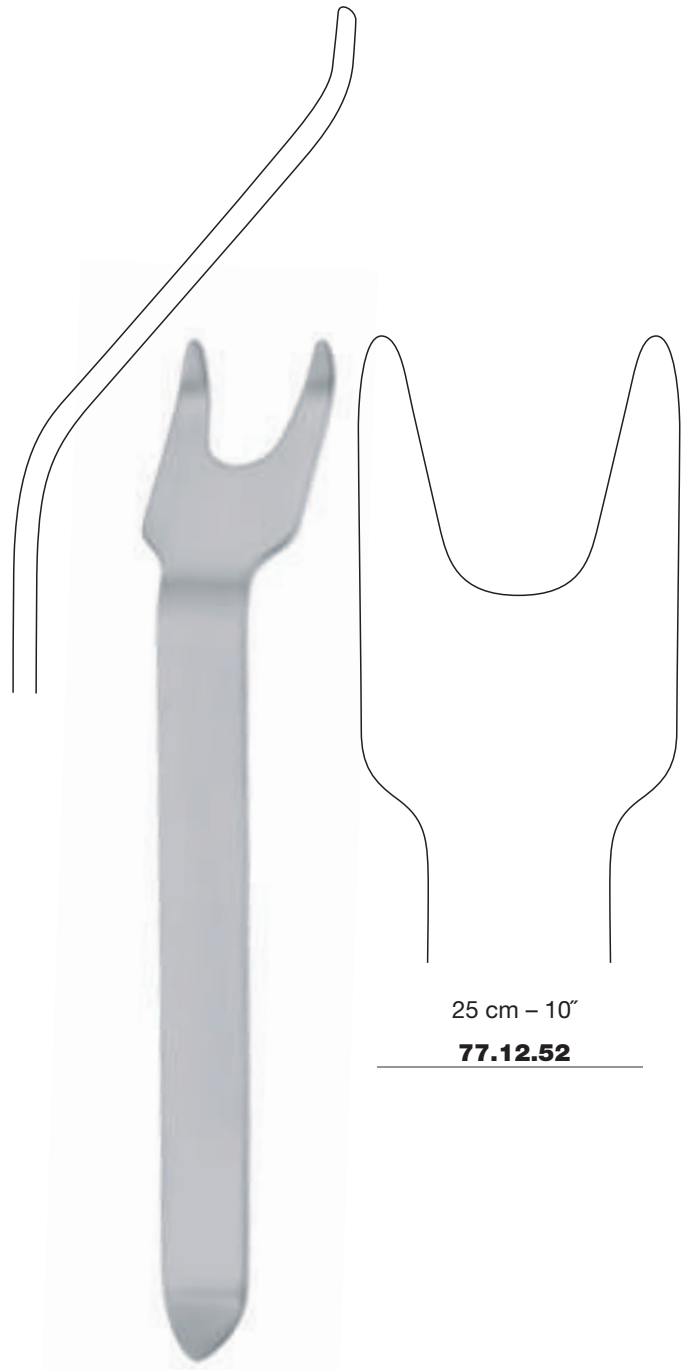

25 cm - 10"

















77.12.52

Blount



Schraubendrehereinsätze, auswechselbar
Screwdriver inserts, interchangeable
Insertos para atornilladores, intercambiables
Inserts pour tournevis, interchangeables
Insertos per cacciavite, intercambiabile

Schraubendrehereinsätze
 Screwdriver inserts
 Insertos para atornilladores
 Inserts pour tournevis
 Inserti per cacciavite

	75.22.62		flach flat plano plat piatto
	75.22.63		Kreuzschlitz cross-slot en cruz fente en croix per viti a croce
	75.22.64		Phillips klein Phillips small Phillips pequeño Phillips petit Phillips piccolo
	75.22.65		Phillips groß Phillips large Phillips grande Phillips grand Phillips grande
	75.22.66		Sechskant 1,5 mm hexagon 1,5 mm hexágono 1,5 mm hexagonal 1,5 mm esagono 1,5 mm
	75.22.67		Sechskant 2,5 mm hexagon 2,5 mm hexágono 2,5 mm hexagonal 2,5 mm esagono 2,5 mm
	75.22.68		Sechskant 3,5 mm hexagon 3,5 mm hexágono 3,5 mm hexagonal 3,5 mm esagono 3,5 mm
	75.22.69		Sechskant 4,5 mm hexagon 4,5 mm hexágono 4,5 mm hexagonal 4,5 mm esagono 4,5 mm



20 cm – 8"

Schraubendrehergriff
 Screwdriver handle
 Mango para atornillador
 Manche pour tournevis
 Manico per cacciavite



75.22.61

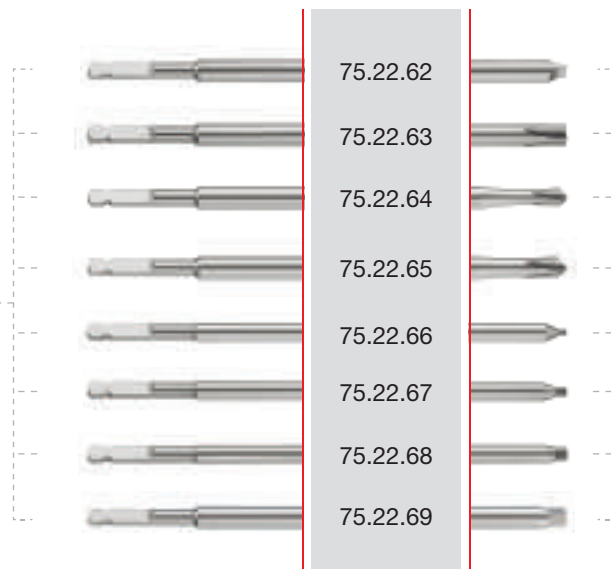

75.22.60

Schraubendreher-Satz
 Screwdriver set
 Juego de atornillador
 Jeu de tournevis
 Set di cacciavite



Schraubendreher
Screwdriver
Atornilladores
Tournevis
Cacciavite

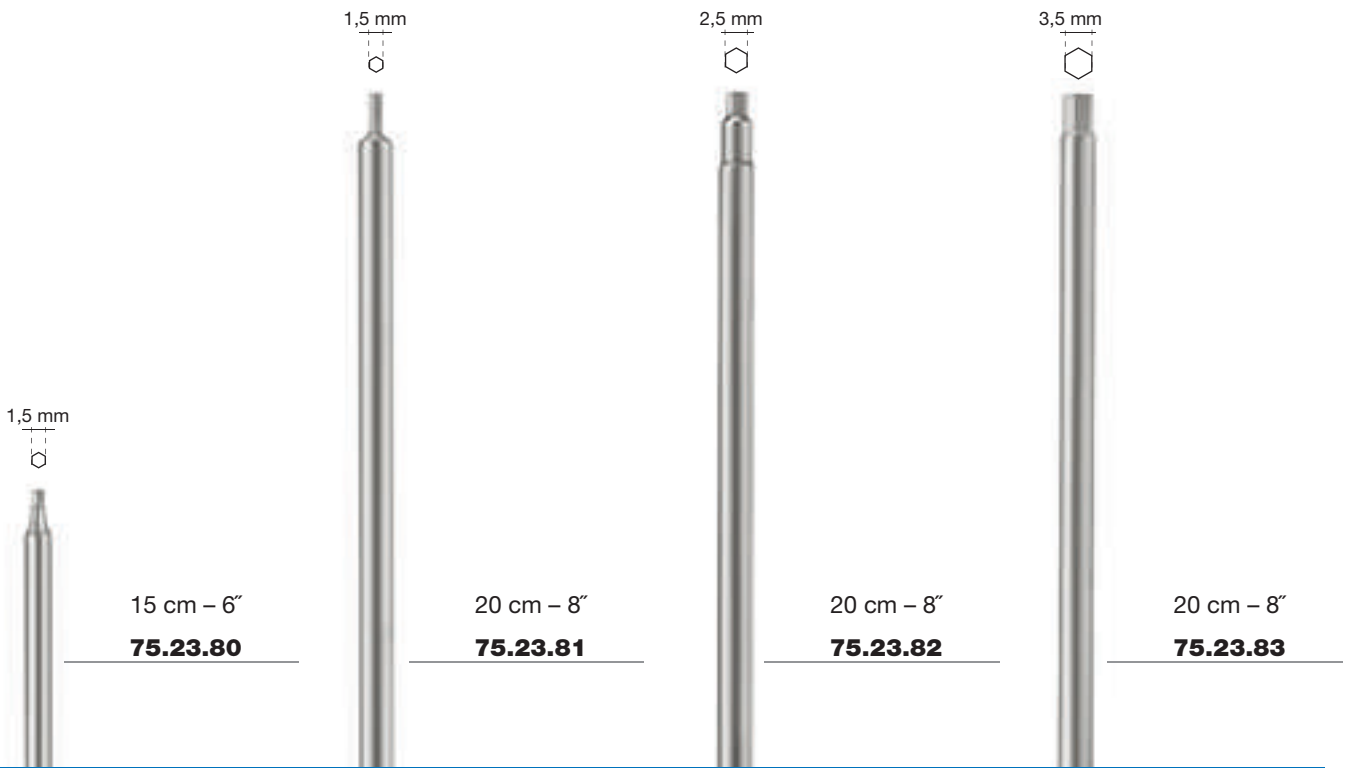

Messinstrumente
Measuring Instruments
Instrumentos de medida
Instrumenti de mesure
Strumenti per misurazione



1,5 m

44.35.15

Leinen-Bandmaß, graduiert in mm
 Tape measure, linen, graduated in mm
 Cinta métrica de tela, graduada en mm
 Mètre à ruban en toile, graduée en mm
 Nastro metrico di tela, graduato in mm

Stahllineale, rostfrei
 Rulers, stainless steel
 Reglas de acero, inoxidable
 Règles en acier, inoxydable
 Righe in acciaio, inossidabile



graduiert in mm und Zoll
 graduated in mm and inches
 graduado en mm y pulgadas
 graduée en mm et pouces
 graduate in mm e pollici

15 cm – 6"

44.37.15

20 cm – 8"

44.37.20

30 cm – 11³/₄"

44.37.30

50 cm – 19³/₄"

44.37.50



Messinstrumente
Measuring Instruments
Instrumentos de medida
Instrumenti de mesure
Strumenti per misurazione

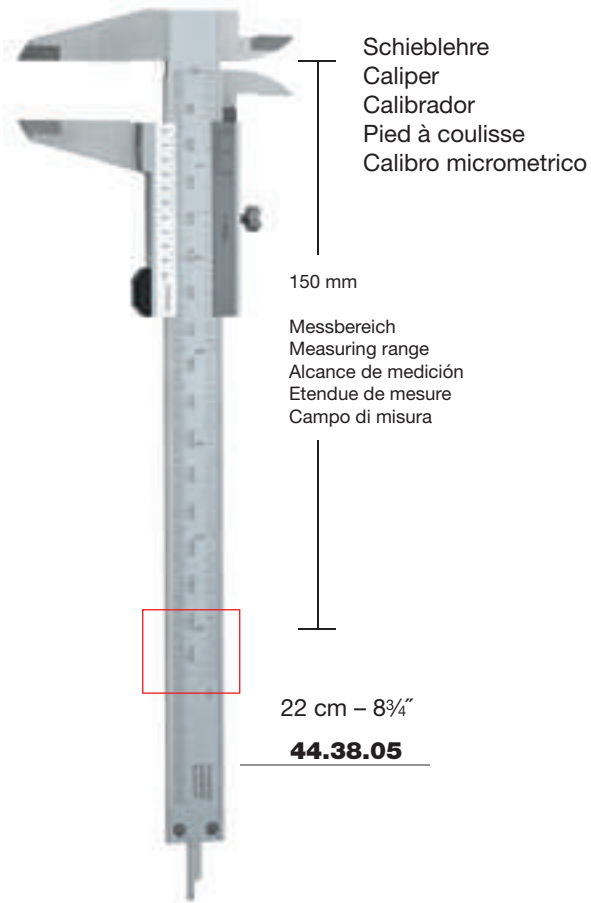

Schieblehre
Caliper
Calibrador
Pied à coulisse
Calibro micrometrico

150 mm

Messbereich
Measuring range
Alcance de medición
Etendue de mesure
Campo di misura

22 cm – 8¾"

44.38.05



zusammenlegbar
folding
plegable
pliable
pieghevole

Winkelmesser
Flexometer
Goniómetro
Goniomètre
Goniometro

23,5 cm – 9¼"

44.38.10

Möltgen

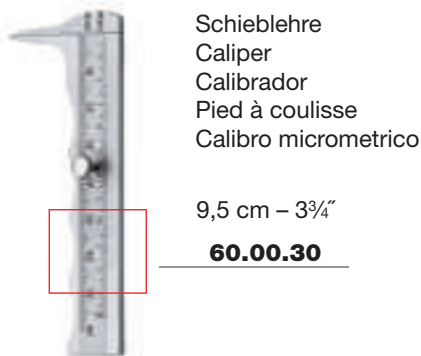

Schieblehre
Caliper
Calibrador
Pied à coulisse
Calibro micrometrico

9,5 cm – 3¾"

60.00.30



Finger-Goniometer
Finger goniometer
Goniómetro para dedos
Goniomètre pour doigts de mains
Goniometro per le dita

14,5 cm – 5¾"

44.38.30

Jameson



graduiert in mm und Zoll
graduated in mm and inches
graduado en mm y pulgadas
graduée en mm et pouces
graduato in mm e pollici

ORTHOPAEDICS

IMPLANTS AND INSTRUMENTS

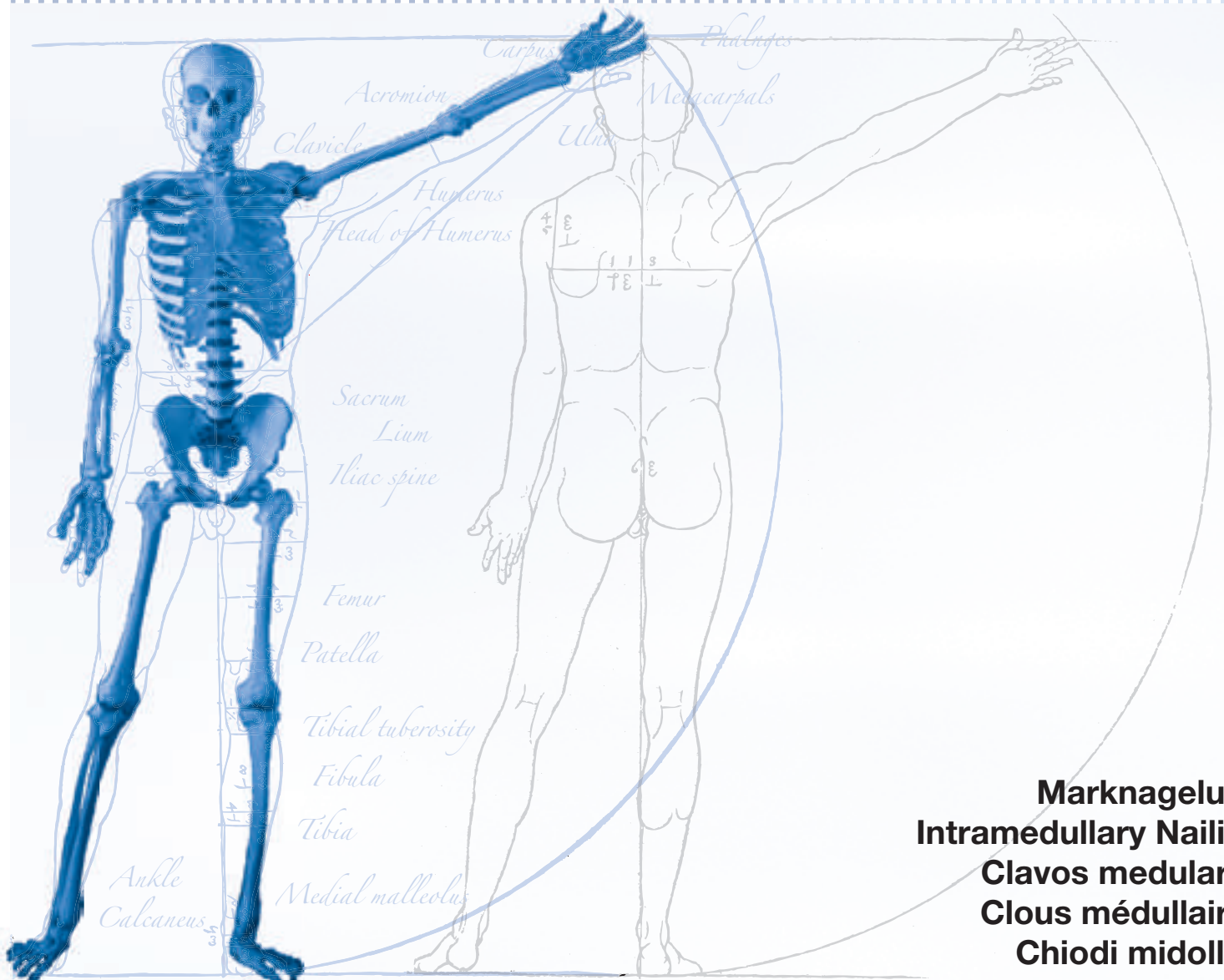

Marknagelung
Intramedullary Nailing
Clavos medulares
Clous médullaires
Chiodi midollari

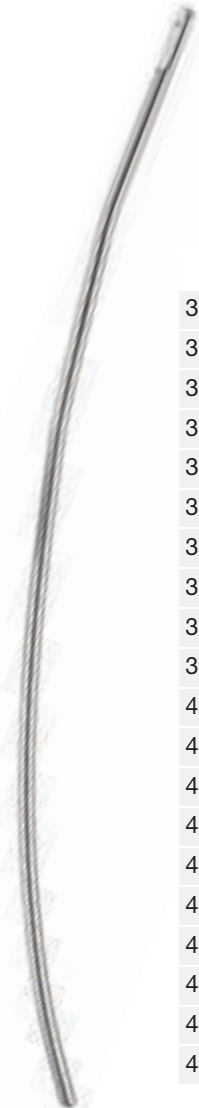

Ender Marknagelung
Ender Intramedullary Nailing
Ender Clavos medulares
Ender Clous médullaires
Ender Chiodi midollari

**Ender**

	Ø 4,5 mm
30 cm – 11¾"	75.66.30
31 cm – 12¾"	75.66.31
32 cm – 12½"	75.66.32
33 cm – 13"	75.66.33
34 cm – 13¾"	75.66.34
35 cm – 13¾"	75.66.35
36 cm – 14½"	75.66.36
37 cm – 14½"	75.66.37
38 cm – 15"	75.66.38
39 cm – 15¾"	75.66.39
40 cm – 15¾"	75.66.40
41 cm – 16½"	75.66.41
42 cm – 16½"	75.66.42
43 cm – 17"	75.66.43
44 cm – 17½"	75.66.44
45 cm – 17¾"	75.66.45
46 cm – 18½"	75.66.46
47 cm – 18½"	75.66.47
48 cm – 19"	75.66.48
49 cm – 19¼"	75.66.49

**75.66.05**

Einbringinstrument
 Inserting instrument
 Instrumento para insertar
 Instrument pour insertion
 Strumento da inserire

Für, for, para, pour, per 75.66.30 - 49

**75.66.06**

Einschläger
 Impactor
 Impacteur
 Inseritore

Ender Marknagelung
Ender Intramedullary Nailing
Ender Clavos medulares
Ender Clous médullaires
Ender Chiodi midollari



75.66.07
 Einschläger/Ausschläger
 Impactor/extractor
 Impactor/extractor
 Impacteur/extracteur
 Inseritore/estrattore



75.66.08
 Extraktionsinstrument
 Extracting instrument
 Instrumento para extracción
 Instrument pour extraction
 Strumento per estrazione



20,5 cm – 8"
75.49.53
 Biegehebel
 Bending tool
 Palanca para doblar
 Levier à plier
 Leva piegare



Haken-Marknägel
Intramedullary Hook-end Nails
Clavos medulares con gancho
Clous médullaires à crochet
Chiodi midollari ad uncino

für Finger, Fuß und Clavicula
 for finger, foot and clavicle
 para dedo, pie y clavícula
 pour doigt, pied et clavicule
 per dita, piede e clavicola

für Unterarm und Clavicula
 for forearm and clavicle
 para antebrazo y clavícula
 pour avant-bras et clavicule
 per avambraccio e clavicola

für Unterschenkel und Oberarm
 for tibia and humerus
 para tibia y húmero
 pour tibia et humérus
 per tibia e omero

für Unterarm und Unterschenkel
 for forearm and tibia
 para antebrazo y tibia
 pour avant-bras et tibia
 per avambraccio e tibia



	Ø 2,4 mm	Ø 3,2 mm	Ø 4,8 mm	Ø 6,4 mm
2,5 cm – 1"	75.70.02			
3,0 cm – 1 1/8"	75.70.03			
4,0 cm – 1 1/2"	75.70.04			
4,5 cm – 1 3/4"	75.70.54			
5,0 cm – 2"	75.70.05			
6,0 cm – 2 3/8"	75.70.06			
6,5 cm – 2 1/2"	75.70.56			
7,0 cm – 2 3/4"	75.70.07			
7,5 cm – 3"	75.70.57			
8,5 cm – 3 3/8"	75.70.08			
9,0 cm – 3 1/2"	75.70.09			
9,5 cm – 3 3/4"	75.70.59			
10,0 cm – 4"	75.70.10	75.71.10		
11,5 cm – 4 1/2"	75.70.11	75.71.12		
12,5 cm – 5"	75.70.12	75.71.13		
14,0 cm – 5 1/2"	75.70.14	75.71.14		
15,0 cm – 6"	75.70.15	75.71.15		
16,5 cm – 6 1/2"	75.70.17	75.71.16		
18,0 cm – 7 1/8"	75.70.18	75.71.17		
19,0 cm – 7 1/2"	75.70.19	75.71.19		
20,5 cm – 8"	75.70.20	75.71.20	75.72.20	
21,5 cm – 8 1/2"	75.70.21	75.71.21		
23,0 cm – 9"	75.70.22	75.71.22	75.72.22	
24,0 cm – 9 1/2"	75.70.23	75.71.24	75.72.24	
25,5 cm – 10"	75.70.24	75.71.25	75.72.26	
28,0 cm – 11"			75.72.28	75.73.28
29,5 cm – 11 1/2"			75.72.30	75.73.29
31,5 cm – 12 3/8"			75.72.32	75.73.32
33,5 cm – 13 1/8"			75.72.34	75.73.34
35,5 cm – 14"			75.72.36	75.73.36
37,5 cm – 14 3/4"				75.73.37
39,5 cm – 15 1/2"				75.73.39
41,0 cm – 16 1/8"				75.73.41
43,0 cm – 17"				75.73.43

Haken-Marknägel
Intramedullary Hook-end Nails
Clavos medulares con gancho
Clous médullaires à crochet
Chiodi midollari ad uncino



75.70.00

- ▶ Satz von 13 Haken-Marknägeln, Ø 2,4 mm, bestehend aus je 1 Stück 25 mm bis 100 mm Länge
- ▶ Set of 13 intramedullary hook-end nails, Ø 2,4 mm, consisting of 1 piece each 25 mm to 100 mm length
- ▶ Juego de 13 clavos medulares con gancho, Ø 2,4 mm, compuesto de 1 pieza de cada uno de los largos de 25 hasta 100 mm
- ▶ Jeu de 13 clous médullaires à crochet, Ø 2,4 mm, se composant de 1 pièce de chacune des longueurs de 25 à 100 mm
- ▶ Serie di 13 chiodi midollari ad uncino, Ø 2,4 mm, composta da 1 pezzo per tipo da 25 fino a 100 mm

75.71.00

- ▶ Satz von 13 Haken-Marknägeln, Ø 3,2 mm, bestehend aus je 1 Stück 100 mm bis 250 mm Länge
- ▶ Set of 13 intramedullary hook-end nails, Ø 3,2 mm, consisting of 1 piece each 100 mm to 250 mm length
- ▶ Juego de 13 clavos medulares con gancho, Ø 3,2 mm, compuesto de 1 pieza de cada uno de los largos de 100 hasta 250 mm
- ▶ Jeu de 13 clous médullaires à crochet, Ø 3,2 mm, se composant de 1 pièce de chacune des longueurs de 100 à 250 mm
- ▶ Serie di 13 chiodi midollari ad uncino, Ø 3,2 mm, composta da 1 pezzo per tipo da 100 fino a 250 mm

75.72.00

- ▶ Satz von 9 Haken-Marknägeln, Ø 4,8 mm, bestehend aus je 1 Stück 205 mm bis 355 mm Länge
- ▶ Set of 9 intramedullary hook-end nails, Ø 4,8 mm, consisting of 1 piece each 205 mm to 355 mm length
- ▶ Juego de 9 clavos medulares con gancho, Ø 4,8 mm, compuesto de 1 pieza de cada uno de los largos de 205 hasta 355 mm
- ▶ Jeu de 9 clous médullaires à crochet, Ø 4,8 mm, se composant de 1 pièce de chacune des longueurs de 205 à 355 mm
- ▶ Serie di 9 chiodi midollari ad uncino, Ø 4,8 mm, composta da 1 pezzo per tipo da 205 fino a 355 mm

75.73.00

- ▶ Satz von 9 Haken-Marknägeln, Ø 6,4 mm, bestehend aus je 1 Stück 280 mm bis 430 mm Länge
- ▶ Set of 9 intramedullary hook-end nails, Ø 6,4 mm, consisting of 1 piece each 280 mm to 430 mm length
- ▶ Juego de 9 clavos medulares con gancho, Ø 6,4 mm, compuesto de 1 pieza de cada uno de los largos de 280 hasta 430 mm
- ▶ Jeu de 9 clous médullaires à crochet, Ø 6,4 mm, se composant de 1 pièce de chacune des longueurs de 280 à 430 mm
- ▶ Serie di 9 chiodi midollari ad uncino, Ø 6,4 mm, composta da 1 pezzo per tipo da 280 fino a 430 mm



Haken-Marknägel
Intramedullary Hook-end Nails
Clavos medulares con gancho
Clous médullaires à crochet
Chiodi midollari ad uncino

Vorbohrer für Haken-Marknägel
 Taps for intramedullary hook-end nails
 Preperforador para clavos medulares con gancho
 Perforateurs initiaux pour clous médullaires à crochet
 Punteruolo per chiodi midollari ad uncino



für Nägel
 for nails
 para clavos
 pour clous
 per chiodi

75.74.22	75.74.23	75.74.24	75.74.26
18 cm – 7 ¹ / ₈ "	22 cm – 8 ³ / ₄ "	26 cm – 10 ¹ / ₄ "	27 cm – 10 ³ / ₄ "
Ø 2,4 mm	Ø 3,2 mm	Ø 4,8 mm	Ø 6,4 mm



Ein- und Ausschlaginstrument für Haken-Marknägel,
 mit Querbohrung zum Biegen
 Impactor and Extractor for intramedullary hook-end nails,
 with cross-bore for bending
 Impactor para clavos medulares con gancho,
 con taladro transversal para doblar
 Impacteur-extracteur pour clous médullaires à crochet,
 à forage transversal pour les plier
 Introduttore-estrattore di chiodi midollari ad uncino,
 con foro per piegare i chiodi

für Nägel
 for nails
 para clavos
 pour clous
 per chiodi

75.74.52	75.74.53	75.74.54	75.74.56
Ø 2,4 mm	Ø 3,2 mm	Ø 4,8 mm	Ø 6,4 mm

ORTHOPAEDICS

IMPLANTS AND INSTRUMENTS

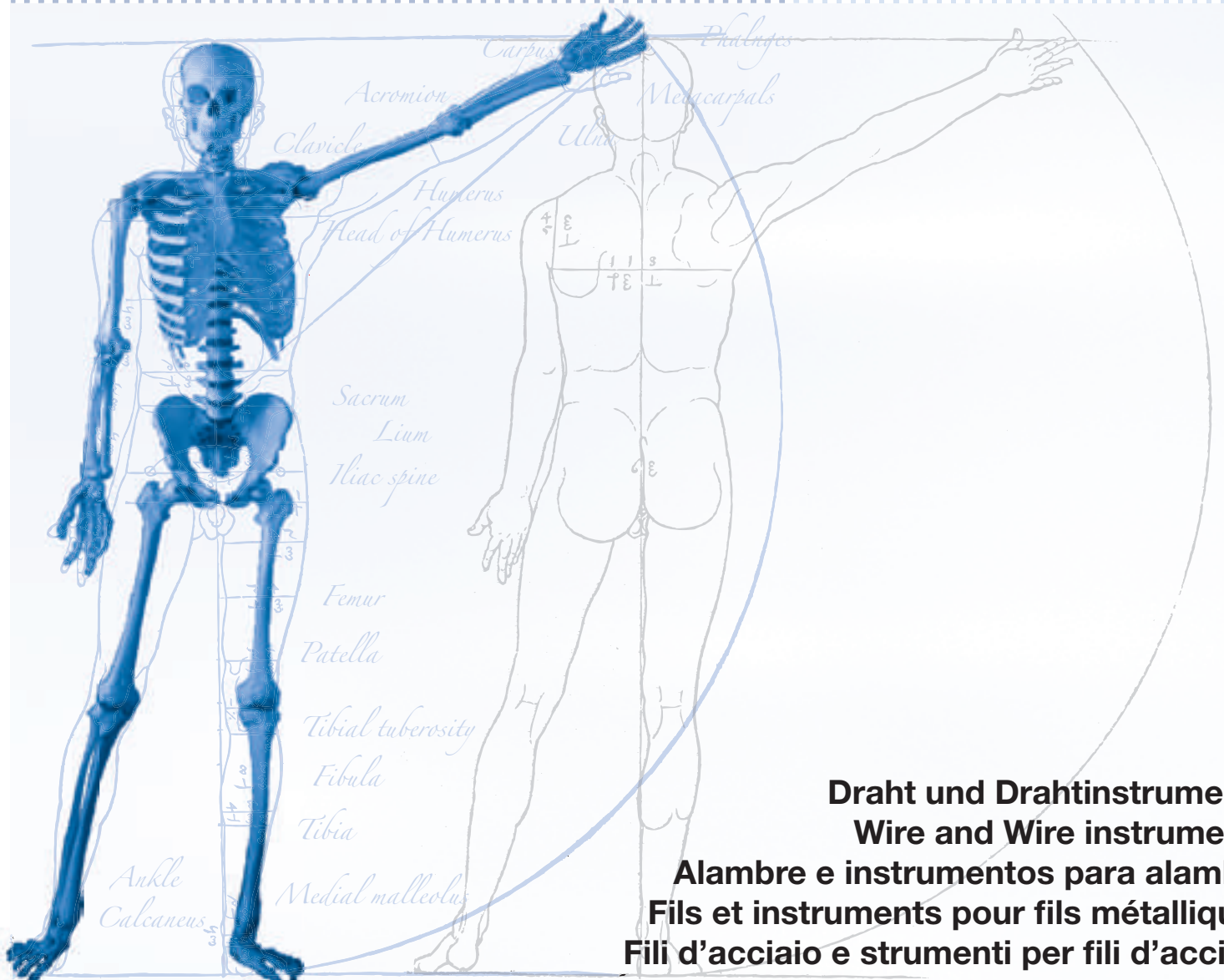

Draht und Drahtinstrumente
Wire and Wire instruments
Alambre e instrumentos para alambre
Fils et instruments pour fils métalliques
Fili d'acciaio e strumenti per fili d'acciaio



KIRSCHNER Bohrdrähte
KIRSCHNER Wires
KIRSCHNER Brocas
KIRSCHNER Broches
KIRSCHNER Fili perforatori



1:1

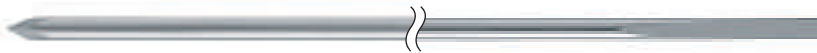

	6 cm – 2"	10 cm – 4"	12 cm – 4¾"	15 cm – 6"	23 cm – 9"	31 cm – 12½"
Ø 0,8 mm	76.06.08	76.07.08	76.08.10	76.10.08	76.11.08	76.12.08
Ø 0,9 mm	76.06.09	76.07.09	76.08.11	76.10.09	76.11.09	76.12.09
Ø 1,0 mm	76.06.10	76.07.10	76.08.12	76.10.10	76.11.10	76.12.10
Ø 1,1 mm	76.06.11	76.07.11	76.08.13	76.10.11	76.11.11	76.12.11
Ø 1,2 mm	76.06.12	76.07.12	76.08.14	76.10.12	76.11.12	76.12.12
Ø 1,3 mm	76.06.13	76.07.13	76.08.15	76.10.13	76.11.13	76.12.13
Ø 1,4 mm	76.06.14	76.07.14	76.08.16	76.10.14	76.11.14	76.12.14
Ø 1,5 mm	76.06.15	76.07.15	76.08.17	76.10.15	76.11.15	76.12.15
Ø 1,6 mm	76.06.16	76.07.16	76.08.18	76.10.16	76.11.16	76.12.16
Ø 1,7 mm	76.06.17	76.07.17	76.08.19	76.10.17	76.11.17	76.12.17
Ø 1,8 mm	76.06.18	76.07.18	76.08.20	76.10.18	76.11.18	76.12.18
Ø 1,9 mm	76.06.19	76.07.19	76.08.21	76.10.19	76.11.19	76.12.19
Ø 2,0 mm	76.06.20	76.07.20	76.08.22	76.10.20	76.11.20	76.12.20
Ø 2,2 mm	76.06.22	76.07.22	76.08.23	76.10.22	76.11.22	76.12.22
Ø 2,4 mm						76.12.24
Ø 2,5 mm	76.06.25	76.07.25	76.08.24	76.10.25	76.11.25	76.12.25
Ø 3,0 mm					76.11.30	76.12.30



1:1



	6 cm – 2¾"	10 cm – 4"	12 cm – 4¾"	15 cm – 6"	23 cm – 9"	31 cm – 12½"
Ø 0,8 mm	76.06.58	76.07.58	76.08.30	76.10.58	76.11.58	76.12.58
Ø 0,9 mm	76.06.59	76.07.59	76.08.31	76.10.59	76.11.59	76.12.59
Ø 1,0 mm	76.06.40	76.07.60	76.08.32	76.10.60	76.11.60	76.12.60
Ø 1,1 mm	76.06.61	76.07.61	76.08.33	76.10.61		
Ø 1,2 mm	76.06.62	76.07.62	76.08.34	76.10.62	76.11.62	76.12.62
Ø 1,3 mm	76.06.63	76.07.63	76.08.35	76.10.63		
Ø 1,4 mm	76.06.64	76.07.64	76.08.36	76.10.64	76.11.64	76.12.64
Ø 1,5 mm	76.06.65	76.07.65	76.08.37	76.10.65	76.11.65	76.12.65
Ø 1,6 mm	76.06.66	76.07.66	76.08.38	76.10.66	76.11.66	76.12.66
Ø 1,7 mm	76.06.67	76.07.67	76.08.39	76.10.67	76.11.67	76.12.67
Ø 1,8 mm	76.06.68	76.07.68	76.08.40	76.10.68	76.11.68	76.12.68
Ø 1,9 mm	76.06.69	76.07.69	76.08.41	76.10.69		
Ø 2,0 mm	76.06.70	76.07.70	76.08.42	76.10.70	76.11.70	76.12.70
Ø 2,2 mm	76.06.72	76.07.72	76.08.43	76.10.72	76.11.72	76.12.72
Ø 2,5 mm	76.06.75	76.07.75	76.08.44	76.10.75	76.11.75	76.12.75
Ø 3,0 mm					76.11.80	76.12.80



Verpackungseinheit "X" Stück
 Packing unit "X" pieces
 Paquete de "X" unidades
 Emballage de "X" pièces
 Confezione da "X" pezzi



Trokarspitze
 Trocar point
 Punta de trocar
 Pointe trocart
 Punta a trequarti



Flaches Schaftende
 Flat shaft end
 Extremo del vástago plano
 Bout de tige plat
 Estremità piatta



Rundes Schaftende
 Round end
 Extremo del vástago redondo
 Bout de tige rond
 Estremità tonda



KIRSCHNER Bohrdrähte
KIRSCHNER Wires
KIRSCHNER Brocas
KIRSCHNER Broches
KIRSCHNER Fili perforatori

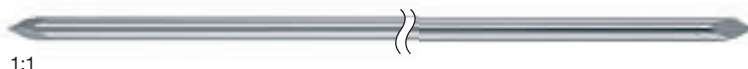

	6 cm – 2 ³ / ₈ "	10 cm – 4"	12 cm – 4 ³ / ₄ "	15 cm – 6"	31cm – 12 ¹ / ₈ "
Ø 0,8 mm	76.06.78	76.07.78	76.08.50	76.10.78	76.13.08
Ø 0,9 mm	76.06.79	76.07.79	76.08.51	76.10.79	
Ø 1,0 mm	76.06.80	76.07.80	76.08.52	76.10.80	76.13.10
Ø 1,1 mm	76.06.81	76.07.81	76.08.53	76.10.81	
Ø 1,2 mm	76.06.82	76.07.82	76.08.54	76.10.82	76.13.12
Ø 1,3 mm	76.06.83	76.07.83	76.08.55	76.10.83	
Ø 1,4 mm	76.06.84	76.07.84	76.08.56	76.10.84	76.13.14
Ø 1,5 mm	76.06.85	76.07.85	76.08.57	76.10.85	76.13.15
Ø 1,6 mm	76.06.86	76.07.86	76.08.58	76.10.86	76.13.16
Ø 1,7 mm	76.06.87	76.07.87	76.08.59	76.10.87	
Ø 1,8 mm	76.06.88	76.07.88	76.08.60	76.10.88	76.13.18
Ø 1,9 mm	76.06.89	76.07.89	76.08.61	76.10.89	
Ø 2,0 mm	76.06.90	76.07.90	76.08.62	76.10.90	76.13.20
Ø 2,2 mm	76.06.92	76.07.92	76.08.63	76.10.92	76.13.22
Ø 2,5 mm	76.06.95	76.07.95	76.08.64	76.10.95	76.13.25
Ø 3,0 mm				76.11.00	76.13.30

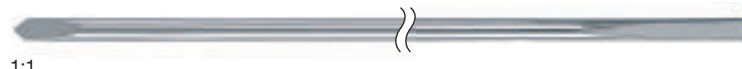

	31cm – 12 ¹ / ₈ "
Ø 0,8 mm	76.15.08
Ø 1,0 mm	76.15.10
Ø 1,2 mm	76.15.12
Ø 1,4 mm	76.15.14
Ø 1,5 mm	76.15.15
Ø 1,6 mm	76.15.16
Ø 1,7 mm	76.15.17
Ø 1,8 mm	76.15.18
Ø 1,9 mm	76.15.19
Ø 2,0 mm	76.15.20
Ø 2,2 mm	76.15.22
Ø 2,5 mm	76.15.25
Ø 3,0 mm	76.15.30



Verpackungseinheit "X" Stück
 Packing unit "X" pieces
 Paquete de "X" unidades
 Emballage de "X" pièces
 Confezione da "X" pezzi



Trokarspitze
 Trocar point
 Punta de trocar
 Pointe trocar
 Punta a tre quarti



Lanzenspitze
 Lancet point
 Punta lanceolar
 Pointe lancéolée
 Punta a forma di lancetta



Flaches Schaftende
 Flat shaft end
 Extremo del vástago plano
 Bout de tige plat
 Estremità piatta



STEINMANN Nägel
STEINMANN Nails
STEINMANN Clavos
STEINMANN Clous
STEINMANN Chiodi



1:1



	14 cm – 5½"	16 cm – 6¼"	18 cm – 7⅛"	20 cm – 8"	23 cm – 9"	26 cm – 10¼"
Ø 2,0 mm			76.21.20		76.21.70	
Ø 2,5 mm			76.21.25		76.21.75	
Ø 3,0 mm			76.21.30		76.21.80	
Ø 3,5 mm	76.17.00	76.17.09	76.21.35	76.17.18	76.21.85	76.17.27
Ø 4,0 mm	76.17.01	76.17.10	76.21.40	76.17.19	76.21.90	76.17.28
Ø 4,5 mm	76.17.02	76.17.11	76.21.45	76.17.20	76.21.95	76.17.29
Ø 5,0 mm	76.17.03	76.17.12	76.21.50	76.17.21	76.22.00	76.17.30



1:1



	14 cm 5½"	15 cm 6"	16 cm 6¼"	18 cm 7⅛"	20 cm 8"	21 cm 8¼"	23 cm 9"	26 cm 10¼"
Ø 2,0 mm				76.22.20			76.22.70	
Ø 2,5 mm				76.22.25			76.22.75	
Ø 3,0 mm				76.22.30			76.22.80	
Ø 3,5 mm	76.17.51		76.17.60	76.22.35	76.17.69		76.22.85	76.17.78
Ø 4,0 mm	76.17.52	76.44.15	76.44.16	76.22.40	76.44.20	76.44.21	76.22.90	76.17.79
Ø 4,5 mm	76.17.53		76.17.62	76.22.45	76.17.71		76.22.95	76.17.80
Ø 5,0 mm	76.17.54		76.17.63	76.22.50	76.17.72		76.23.00	76.17.81



Trokarspitze
Trocar point
Punta de trocar
Pointe trocar
Punta a trequarti



Vierkant-Schaftende
Square shaft end
Extremo de vástago cuadrado
Bout de tige quatre-pans
Estremità quadrangolare



STEINMANN Nägel
STEINMANN Nails
STEINMANN Clavos
STEINMANN Clous
STEINMANN Chiodi



	14 cm – 5½"	16 cm – 6¼"	18 cm – 7⅛"	20 cm – 8"	23 cm – 9"	26 cm – 10¼"
Ø 2,0 mm			76.23.20		76.23.70	
Ø 2,5 mm			76.23.25		76.23.75	
Ø 3,0 mm			76.23.30		76.23.80	
Ø 3,5 mm	76.18.01	76.18.10	76.23.35	76.18.19	76.23.85	76.18.28
Ø 4,0 mm	76.18.02	76.18.11	76.23.40	76.18.20	76.23.90	76.18.29
Ø 4,5 mm	76.18.03	76.18.12	76.23.45	76.18.21	76.23.95	76.18.30
Ø 5,0 mm	76.18.04	76.18.13	76.23.50	76.18.22	76.24.00	76.18.31

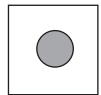

	14 cm – 5½"	16 cm – 6¼"	18 cm – 7⅛"	20 cm – 8"	23 cm – 9"	26 cm – 10¼"
Ø 3,5 mm	76.18.51	76.18.60	76.18.69	76.18.78	76.18.87	76.18.96
Ø 4,0 mm	76.18.52	76.18.61	76.18.70	76.18.79	76.18.88	76.18.97
Ø 4,5 mm	76.18.53	76.18.62	76.18.71	76.18.80	76.18.89	76.18.98
Ø 5,0 mm	76.18.54	76.18.63	76.18.72	76.18.81	76.18.90	76.18.99



Trokarspitze
 Trocar point
 Punta de trocar
 Pointe trocart
 Punta a trequarti



Dreikant-Schaftende
 Triangular shaft end
 Extremo del vástago triangular
 Bout de tige triangulaire
 Estremità triangolare



Rundes Schaftende
 Round end
 Extremo del vástago redondo
 Bout de tige rond
 Estremità tonda

**STEINMANN Nägel / SCHANZ Schrauben / Bohrdrabtbehälter****STEINMANN Nails / SCHANZ Screws / Wire Containers****STEINMANN Clavos / SCHANZ Tornillos / Contenedores para brocas****STEINMANN Clous / SCHANZ Vis / Tubes pour broches****STEINMANN Chiodi / SCHANZ Viti / Contenitori per fili**

1:1

**Steinmann**Mittelgewinde
Center thread
Rosca central
Filetage central
Filettatura centrale

	Ø 4,5 mm	Ø 5,0 mm
15 cm – 6"	76.19.50	76.19.51
18 cm – 7 1/8"	76.19.57	76.19.58
20 cm – 8"	76.19.64	76.19.65



Gewinde-Ø ist 0,5 mm größer als Nagel-Ø
Thread Ø is 0,5 mm larger than nail Ø
Ø rosca es 0,5 mm más grande que el Ø del clavo
Ø du filetage est de 0,5 mm plus grand que Ø du clou
Il Ø della filettatura è 0,5 mm più grande del Ø del chiodo



1:1

**Schanz**Gewinde
Thread
Rosca
Filetage
Filettatura

	Ø 5,0 mm
8 cm – 3 1/8"	76.20.00
12 cm – 4 3/4"	76.20.01
15 cm – 6"	76.20.02
17 cm – 6 3/4"	76.20.03
20 cm – 8"	76.20.04
25 cm – 10"	76.20.05



Gewinde-Ø ist 0,5 mm kleiner als Nagel-Ø
Thread Ø is 0,5 mm smaller than nail Ø
Ø rosca es 0,5 mm más pequeño que el Ø del clavo
Ø du filetage est de 0,5 mm inférieur que Ø du clou
Il Ø della filettatura è 0,5 mm inferiore a Ø del chiodo

Ø 12 mm

**Kirschner**

Lieferung ohne Bohrdrähte
Supplied without wires
Sumministrado sin brocas
Livraison sans broches
Fornitura senza fili

76.16.03
16 cm – 6 1/4"**76.16.04**
19 cm – 7 1/2"**76.16.05**
32 cm – 12 1/2"

15 cm

18 cm

31 cm

für Bohrdrähte bis:
for wires up to:
para brocas hasta:
pour broches jusqu'à:
per fili fino a:

rostfreier 18/8 Stahl
18/8 stainless steel
acero inoxidable 18/8
acier inoxydable 18/8
acciaio inossidabile 18/8



Trokarspitze
Trocar point
Punta de trocar
Pointe trocar
Punta a trequarti



Dreikant-Schaftende
Triangular shaft end
Extremo del vástago triangular
Bout de tige triangulaire
Estremità triangolare

Extensionsbügel
Traction Bows
Estribos de extensión
Etriers à extension
Staffe per trazione

Für Drähte bis max. Ø 2 mm
 For wires of max. Ø 2 mm
 Para alambres de max. Ø 2 mm
 Pour fils à max. Ø 2 mm
 Per fili da max. Ø 2 mm

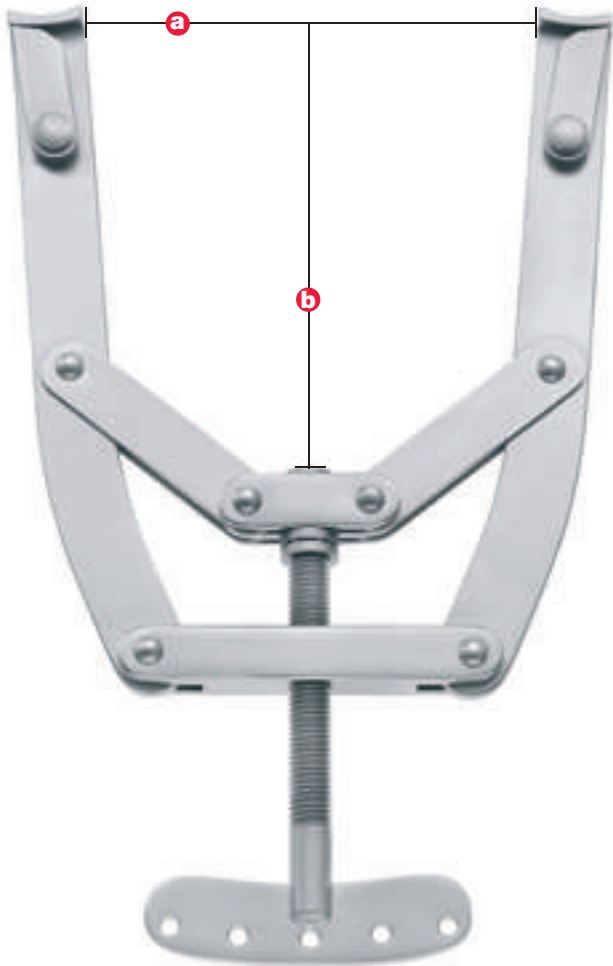

Kirschner
Mod. USA

komplett mit 3 Zughaken
 complete with 3 traction hooks
 completo con 3 ganchos de tracción
 complet avec 3 crochets de traction
 completa di 3 ganci di trazione

76.40.01

a = 4,5 – 13 cm - 1¾" – 5⅛"
b = 1,5 – 10 cm - ½" – 4"

kleines Modell
 small pattern
 modelo pequeño
 petit modèle
 modello piccolo

76.40.03

a = 0 – 16 cm - 0" – 6¼"
b = 9 – 13 cm - 3½" – 5⅛"

großes Modell
 large pattern
 modelo grande
 grand modèle
 modello grande

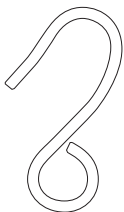

76.41.41

Zughaken allein, klein
 Traction hook only, small
 Gancho de tracción sólo, pequeño
 Crochet de traction seul, petit
 Gancio di trazione solo, piccolo

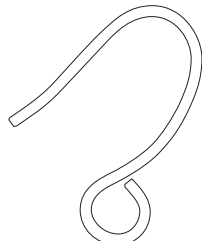

76.41.42

Zughaken allein, groß
 Traction hook only, large
 Gancho de tracción sólo, grande
 Crochet de traction seul, grand
 Gancio di trazione solo, grande

für KIRSCHNER Extensionsbügel
 for KIRSCHNER traction bows
 para KIRSCHNER estribos de extensión
 pour de KIRSCHNER étriers à extension
 per KIRSCHNER staffe per trazione



Extensionsbügel
Traction Bows
Estribos de extensión
Etriers à extension
Staffe per trazione

Für Drähte bis max. Ø 3 mm
 For wires of max. Ø 3 mm
 Para alambres de max. Ø 3 mm
 Pour fils à max. Ø 3 mm
 Per fili da max. Ø 3 mm

**Kirschner**

komplett mit 3 Zughaken
 complete with 3 traction hooks
 completo con 3 ganchos de tracción
 complet avec 3 crochets de traction
 completo di 3 ganci di trazione

76.40.21

a = 4,5 - 13 cm - 1¾" - 5⅛"

b = 10 cm - 4"

kleines Modell
 small pattern
 modelo pequeño
 petit modèle
 modello piccolo

76.40.23

a = 7 - 19 cm - 2¾" - 7½"

b = 16 cm - 6¼"

großes Modell
 large pattern
 modelo grande
 grand modèle
 modello grande



15 cm - 6"

76.40.25

Schraubenschlüssel
 Wrench
 Llave
 Clé
 Chiave

Extensionsbügel
Traction Bows
Estribos de extensión
Etriers à extension
Staffe per trazione

Für Drähte bis max. Ø 2 mm
 For wires of max. Ø 2 mm
 Para alambres de max. Ø 2 mm
 Pour fils à max. Ø 2 mm
 Per fili da max. Ø 2 mm

Kirschner

komplett mit 3 Zughaken
 complete with 3 traction hooks
 completo con 3 ganchos de tracción
 complet avec 3 crochets de traction
 completo di 3 ganci di trazione

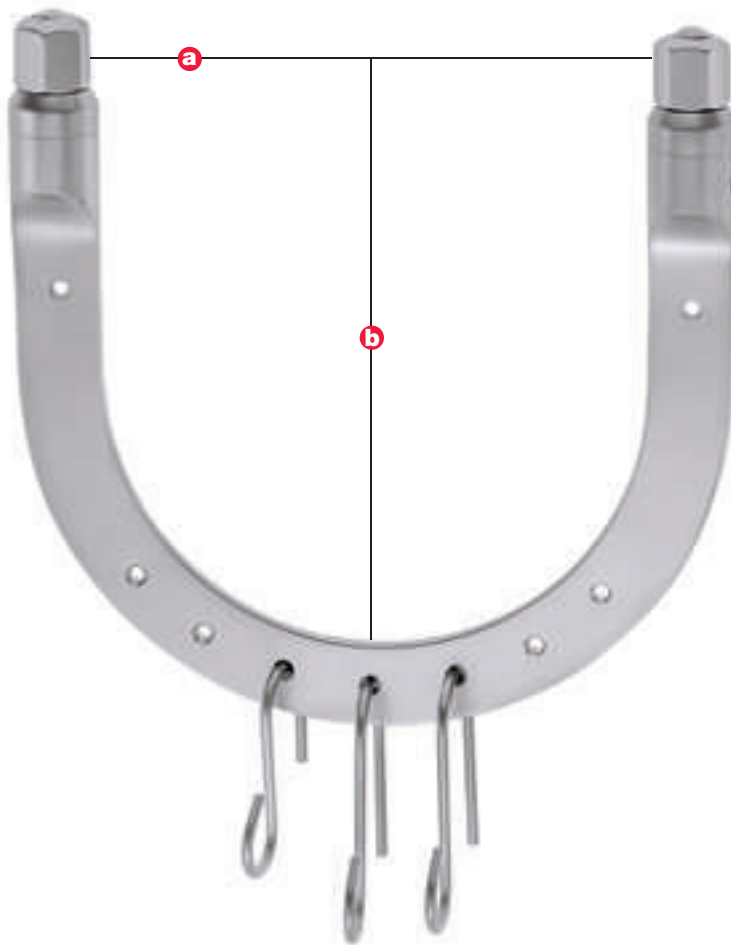

76.41.01	für Hüfte for hip para cadera pour hanche per anca
a = 20,0 cm – 8"	
b = 15,5 cm – 6 1/8"	

76.41.02	für Oberschenkel for femur para fémur pour fémur per femore
a = 15,5 cm – 6 1/8"	
b = 15,5 cm – 6 1/8"	

76.41.03	für Knie for knee para rodilla pour genou per ginocchio
a = 13,5 cm – 5 3/8"	
b = 13,0 cm – 5 1/8"	

76.41.04	für Knie for knee para rodilla pour genou per ginocchio
a = 12,0 cm – 4 3/4"	
b = 12,0 cm – 4 3/4"	

Extensionsbügel
Traction Bows
Estribos de extensión
Etriers à extension
Staffe per trazione

Für Drähte bis max. Ø 2 mm
For wires of max. Ø 2 mm
Para alambres de max. Ø 2 mm
Pour fils à max. Ø 2 mm
Per fili da max. Ø 2 mm

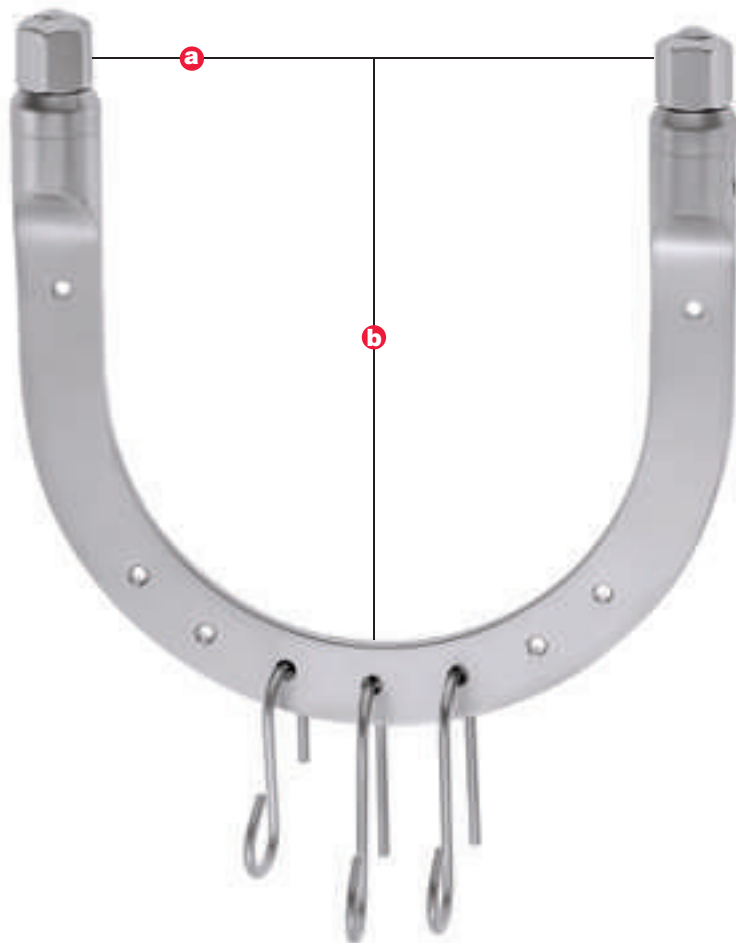
**Kirschner**

komplett mit 3 Zughaken
complete with 3 traction hooks
completo con 3 ganchos de tracción
complet avec 3 crochets de traction
completa di 3 ganci di trazione

76.41.05

- a** = 9,5 cm – 3¾"
b = 11,0 cm – 4¾"

für Fersenbein
for heel
para calcáneo
pour calcanéum
per calcagno

76.41.06

- a** = 9,5 cm – 3¾"
b = 7,0 cm – 2¾"

für Arm
for arm
para brazo
pour bras
per braccio

76.41.07

- a** = 6,0 cm – 2¾"
b = 5,0 cm – 2"

für Ellenbogen
for elbow
para codo
pour coude
per gomito

76.41.50

Fixierscheiben für Bohrdrähte mit Stellschraube, Paar
Fixation discs for wires with setscrew, pair
Discos de fijación para brocas filiformes con tornillo de ajuste, par
Disques de fixation pour broches avec vis de serrage, paire
Dischi di fissaggio per perforatori filiformi con vite di chiusura, paio

76.41.55

Fixierscheiben mit Schlitz und Stellschraube, Paar
Fixation discs with slit and setscrew, pair
Discos de fijación con hendidura y tornillo de ajuste, par
Disques de fixation avec fente et vis de serrage, paire
Dischi di fissaggio con fessura e vite di chiusura, paio

Extensionsbügel
Traction Bows
Estribos de extensión
Etriers à extension
Staffe per trazione

Spannschlüssel zum Spannen des Bohrdrabtes, passend für KIRSCHNER Extensionsbügel Nr. 76.41.01 – 76.41.07
Wrench for tightening the wire, fits KIRSCHNER traction bows No. 76.41.01 – 76.41.07
Llave para tensar las brocas filiformes, apropiada para estribos de extensión KIRSCHNER No. 76.41.01 – 76.41.07
Clé pour tendre la broche, pour étriers KIRSCHNER No. 76.41.01 – 76.41.07
Chiave tenditrice per perforatori filiformi, adatta alle staffe di trazione di KIRSCHNER No. 76.41.01 – 76.41.07



Schraubenschlüssel für die Spannmutter der KIRSCHNER Extensionsbügel Nr. 76.41.01 – 76.41.07
Wrench for adjusting KIRSCHNER traction bow nuts, No. 76.41.01 – 76.41.07
Atornillador para las tuercas tensoras de los estribos de extensión de KIRSCHNER No. 76.41.01 – 76.41.07
Clé pour les écrous-tendeurs des étriers KIRSCHNER No. 76.41.01 – 76.41.07
Chiave per i dadi delle staffe di trazione di KIRSCHNER No. 76.41.01 – 76.41.07



Fixierzwinde zum Halten der Spannmutter des Spannschlüssels Nr. 76.41.20
Spring clamp, stabilizes the adjusting nut of the tightening wrench No. 76.41.20
Manija para sujetar la tuerca de la llave tensora No. 76.41.20
Bride de fixation pour écrou de la clé No. 76.41.20
Morsetto per stringere il dado della chiave tenditrice No. 76.41.20



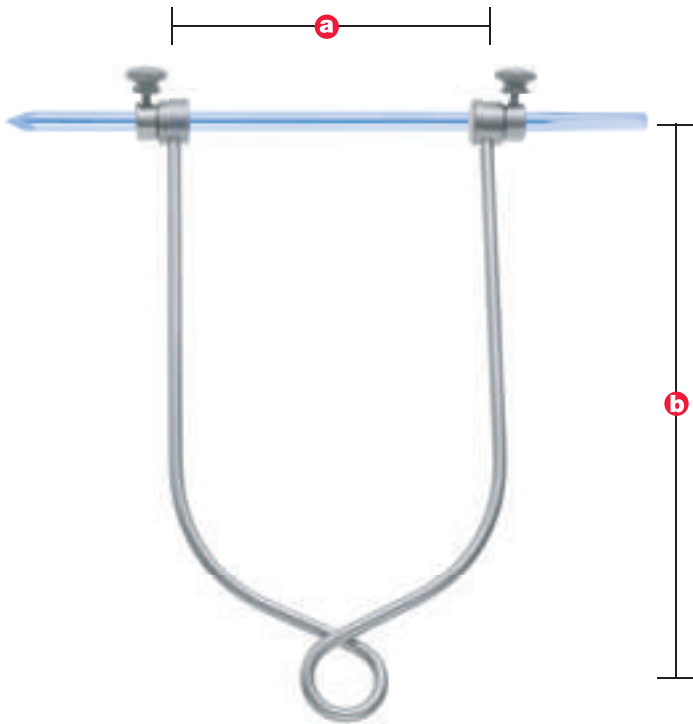

Extensionsbügel
Traction Bows
Estribos de extensión
Etriers à extension
Staffe per trazione

**Böhler****76.44.01**

a = 9 cm – 3½"

b = 16 cm – 6¼"

für Arm
 for arm
 para brazo
 pour bras
 per braccio

komplett mit 1 Nagel Ø 4 mm × 15 cm Nr. 76.44.15
 complete with 1 nail Ø 4 mm × 15 cm No. 76.44.15
 completo con 1 clavo Ø 4 mm × 15 cm No. 76.44.15
 complet avec 1 clou Ø 4 mm × 15 cm No. 76.44.15
 completo di 1 chiodo Ø 4 mm × 15 cm No. 76.44.15

76.44.03

a = 11 cm – 4¾"

b = 21 cm – 8¼"

für Knie und Oberschenkel
 for knee and femur
 para rodilla y femur
 pour genou et fémur
 per ginocchio e femore

komplett mit 1 Nagel Ø 4 mm × 18 cm Nr. 76.22.40
 complete with 1 nail Ø 4 mm × 18 cm No. 76.22.40
 completo con 1 clavo Ø 4 mm × 18 cm No. 76.22.40
 complet avec 1 clou Ø 4 mm × 18 cm No. 76.22.40
 completo di 1 chiodo Ø 4 mm × 18 cm No. 76.22.40

76.44.05

a = 15 cm – 3"

b = 21 cm – 8¼"

für Knie und Oberschenkel
 for knee and femur
 para rodilla y femur
 pour genou et fémur
 per ginocchio e femore

komplett mit 1 Nagel Ø 4 mm × 21 cm Nr. 76.44.21
 complete with 1 nail Ø 4 mm × 21 cm No. 76.44.21
 completo con 1 clavo Ø 4 mm × 21 cm No. 76.44.21
 complet avec 1 clou Ø 4 mm × 21 cm No. 76.44.21
 completo di 1 chiodo Ø 4 mm × 21 cm No. 76.44.21



Handbohrer, Knochendrähte
Hand Drills, Bone Suturing Wires
Perforadoras de mano, Alambre para huesos
Perforateurs à main, Fils d'acier à os
Perforatori a mano, Fili d'acciaio per ossa

mit Dreibacken-Spannfutter, von Hand zu spannen, max. Spannweite 4 mm, kanüliert
 with three-jaw chuck, to be locked by hand, max. spread 4 mm, canulated
 con plato de tres mordazas, tensor, a mano, apertura máxima 4 mm, canulado
 avec mandrin à trois mâchoires, tendre à main, ouverture maximale 4 mm, canulé
 con mandrino a tre ganasce, da tendere a mano, apertura massima 4 mm, canalizzato



78.03.05

mit Jacobs-Dreibacken-Spannfutter mit Spannschlüssel, max. Spannweite 4 mm, kanüliert
 with Jacobs three-jaw chuck and tightening wrench, max. spread 4 mm, canulated
 con plato de tres mordazas de Jacobs, con llave tensora, apertura máxima 4 mm, canulado
 avec mandrin de Jacobs à trois mâchoires, avec clé, ouverture maximale 4 mm, canulé
 con mandrino di Jacobs a tre ganasce, con chiave di tensione, apertura massima 4 mm, canalizzato



78.03.07

76.01.02	Ø 0,25 mm – 31 G
76.01.03	Ø 0,30 mm – 29 G
76.01.04	Ø 0,40 mm – 27 G
76.01.05	Ø 0,50 mm – 25 G
76.01.06	Ø 0,60 mm – 23 G
76.01.07	Ø 0,70 mm – 22 G
76.01.08	Ø 0,80 mm – 21 G
76.01.09	Ø 0,90 mm – 20 G
76.01.10	Ø 1,00 mm – 19 G
76.01.12	Ø 1,20 mm – 18 G
76.01.15	Ø 1,50 mm – 17 G
76.01.18	Ø 1,80 mm – 15 G
76.01.20	Ø 2,00 mm – 14 G



Rolle zu 10 m, weich
 Coil 10 m (33.3 ft.), soft
 Rollo de 10 m, blando
 Rouleau de 10 m, souple
 Rotolo da 10 m, dolce



Drahtumföhrungsnadeln
Wire Guides
Agujas conductoras de alambre
Passe-fils
Aghi passafilo

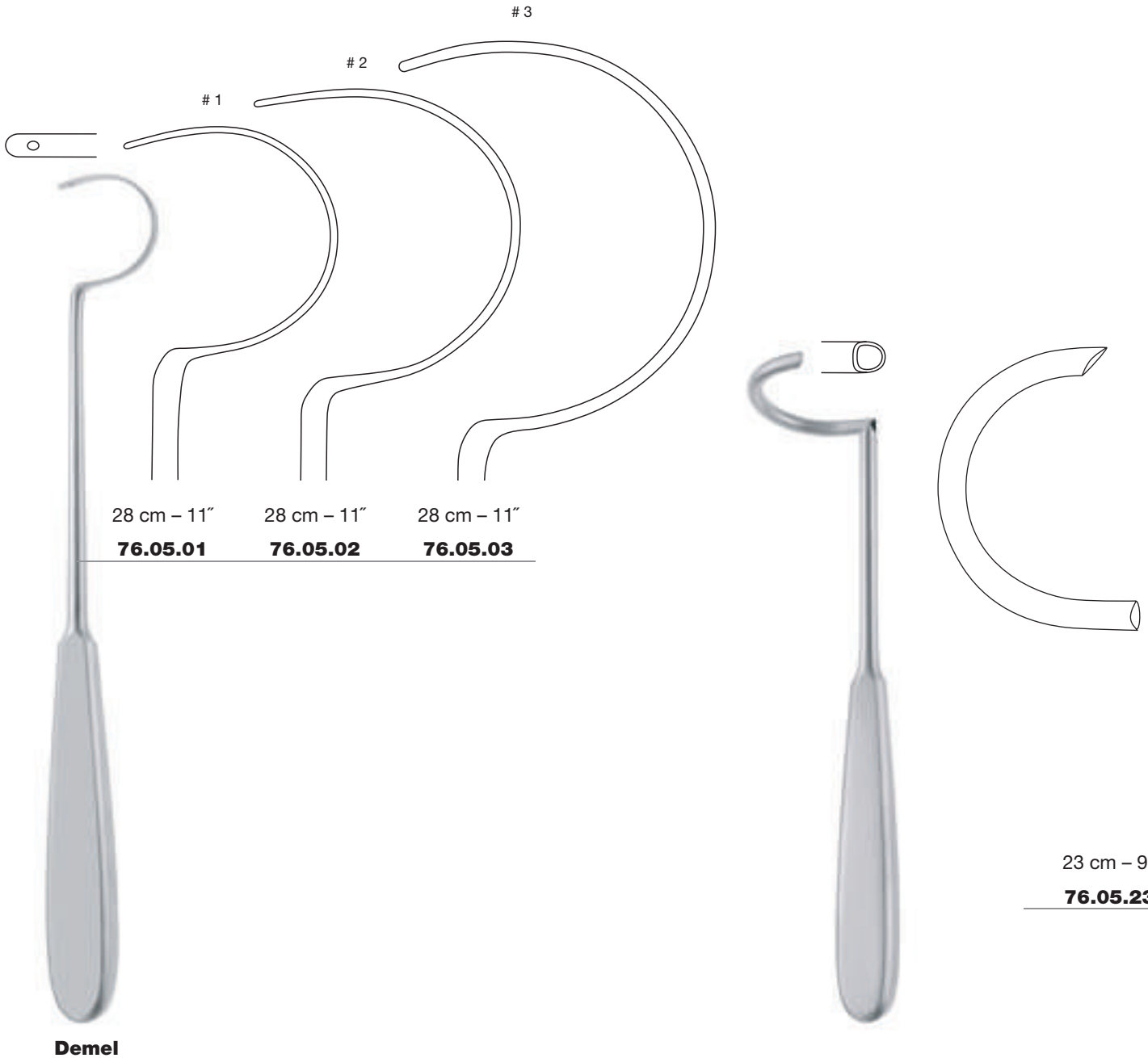

Demel

23 cm - 9"

76.05.23



Drahtumführungsnadeln
Wire Guides
Agujas conductoras de alambre
Passe-fils
Aghi passafilo

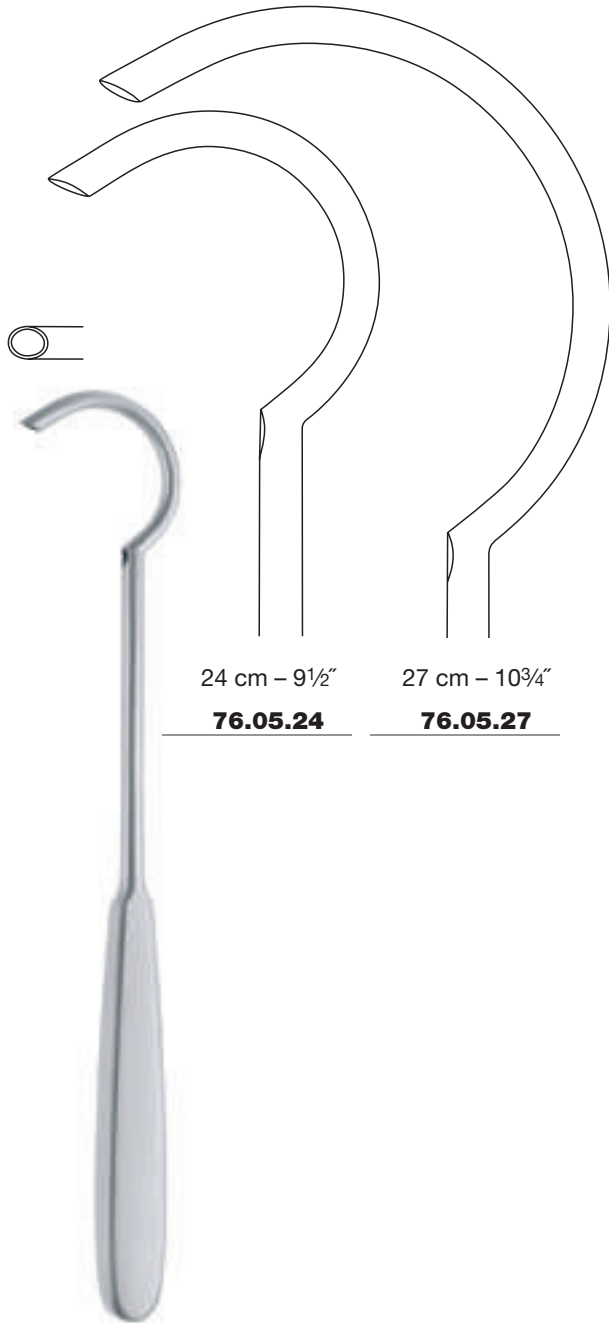

24 cm – 9½”
76.05.24

27 cm – 10¾”
76.05.27



21 cm – 8¼”
76.08.00

21 cm – 8¼”
76.08.01



Kunststoffgriff (autoklavierbar bis 134 °C bei 3 bar)
 Plastic handle (autoclavable up to 134 °C at 3 bar)
 Mango de plástico (autoclavable hasta 134 °C bajo presión de 3 bar)
 Manche en plastique (autoclavable à 134 °C sous pression de 3 bars)
 Manico di plastica (autoclavabile fino a 134 °C sotto pressione di 3 bar)



Drahtspanninstrumente
Wire Tightening Instruments
Instrumentos tensores de alambre
Tendeurs-fil
Strumenti tendifilo metallico

Für Drähte bis max. Ø 1 mm
For wires of max. Ø 1 mm
Para alambres de max. Ø 1 mm
Pour fils à max. Ø 1 mm
Per fili da max. Ø 1 mm



22 cm – 8¾"

76.05.50

Loute



28 cm – 11"

76.05.60

Demel

Drahtspanninstrument
Wire Tightening Instrument
Instrumento tensores de alambre
Tendeur-fil
Strumento tendifilo metallico



Platte dreh- und auswechselbar
Plate rotating and interchangeable
Placa giratoria e intercambiabile
Disque pivotant et interchangeable
Placca girevole ed intercambiabile



Anzeige der Zugkraft mittels Skala bis 125 kg
Indication of traction by scale up to 125 kg
Indicación de la fuerza de tracción mediante una escala hasta 125 kg
Indication de force de traction par échelle jusqu'à 125 kg
Indicazione della forza di trazione tramite una scala fino a 125 kg

26 cm – 10¼"

76.05.65

für Drähte von Ø 1,5 – 2,5 mm
for wires of Ø 1,5 – 2,5 mm
para alambres de Ø 0,5 – 2,5 mm
pour fils à Ø 0,5 – 2,5 mm
per fili da Ø 0,5 – 2,5 mm



Drahtspannzangen, Flachzangen
Wire Twisting Forceps, Flat Nose Pliers
Pinzas tensoras de alambre, Alicates planos
Pinces serre-fil, Pinces plates
Pinze tendifili, Tenaglie piatte

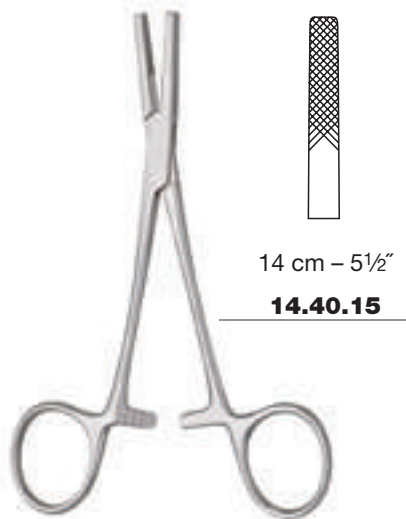

14 cm - 5½"
14.40.15

Niro



14 cm - 5½"
14.40.65

Niro "HM"



15 cm - 6"
14.41.65

"HM"



17 cm - 6¾"
14.44.17

Medicon



17 cm - 6¾"
14.44.67

Medicon "HM"

"HM"
 Hartmetall
 Tungsten carbide
 Carburo de tungsteno
 Carbure de tungstène
 Carburo di tungsteno



Drahtspannzangen, Flachzangen
Wire Twisting Forceps, Flat Nose Pliers
Pinzas tensoras de alambre, Alicates planos
Pinces serre-fil, Pinces plates
Pinze tendifili, Tenaglie piatte



14 cm - 5½"
14.46.14



15 cm - 6"
14.46.15

Universal



5 mm



18 cm - 7⅛"
14.48.05

7 mm

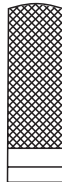

18 cm - 7⅛"
14.48.07

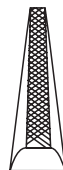

18 cm - 7⅛"
14.48.04



Drahtspannzangen, Flachzangen
Wire Twisting Forceps, Flat Nose Pliers
Pinzas tensoras de alambre, Alicates planos
Pinces serre-fil, Pinces plates
Pinze tendifili, Tenaglie piatte

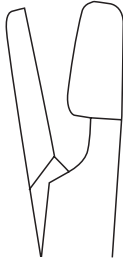

Maulteile gerieft
 serrated jaws
 boca estriada
 mors striés
 morsi striati

17 cm – 6¾"

14.48.01

"HM"



16 cm – 6¼"

14.48.03

Corwin-Hegar "HM"



17 cm – 6¾"

76.45.10



17 cm – 6¾"

76.45.15

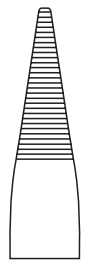

19 cm – 7½"

76.45.19



"HM"

Hartmetall
 Tungsten carbide
 Carburo de tungsteno
 Carbure de tungstène
 Carburo di tungsteno



Draht- und Nagelextraktionszangen
Wire and Nail Extracting Forceps
Pinzas para extraer alambres y clavos
Pinces à extraction fils et clous
Pinze per estrazione di fili e chiodi



18 cm – 7 1/8"
76.45.18



20 cm – 8"
76.45.21

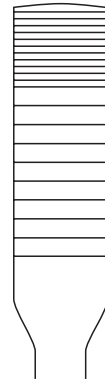

24 cm – 9 1/2"
76.45.22

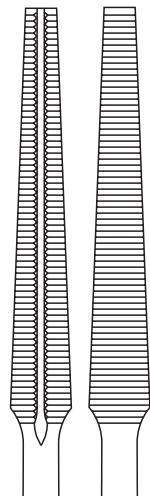

22 cm – 8 3/4"
76.45.25

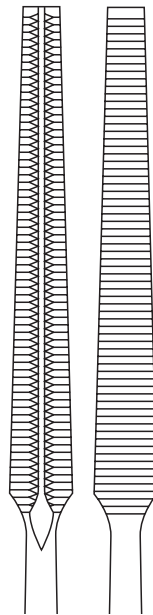

25 cm – 10"
76.45.26

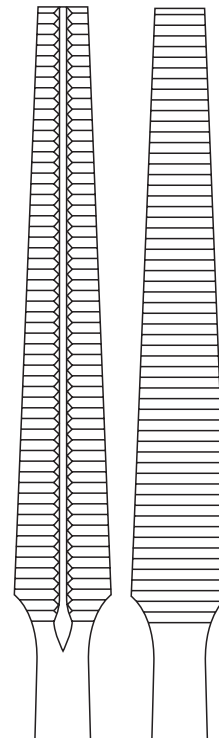

30 cm – 11 3/4"
76.45.27



Draht- und Nagelextraktionszangen
Wire and Nail Extracting Forceps
Pinzas para extraer alambres y clavos
Pinces à extraction fils et clous
Pinze per estrazione di fili e chiodi



mit Seitenschneider für Drähte bis max. Ø 1,6 mm
with side cutter for wires up to max. Ø 1,6 mm
con pinza cortante para alambres hasta máx. Ø 1,6 mm
avec pince coupante pour fils jusqu'à max. Ø 1,6 mm
con pinza tagliente per fili fino a max. Ø 1,6 mm

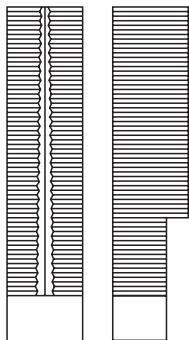

18,5 cm – 7¼"

76.45.29

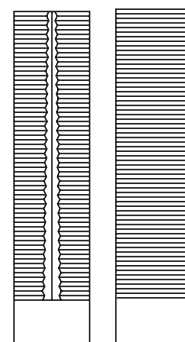

18 cm – 7⅛"

76.45.30



Drahtscheren
Wire Cutting Scissors
Tijeras para cortar alambre
Ciseaux coupe-fil
Forbici per fili d'acciaio



Beebee

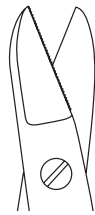

10,5 cm – 4 1/8"

14.24.10



10,5 cm – 4 1/8"

14.24.20



10,5 cm – 4 1/8"

14.26.10



10,5 cm – 4 1/8"

14.26.20



10,5 cm – 4 1/8"

14.25.10

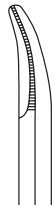

10,5 cm – 4 1/8"

14.25.20



10,5 cm – 4 1/8"

14.27.10



10,5 cm – 4 1/8"

14.27.20



12,5 cm – 5"

14.24.12

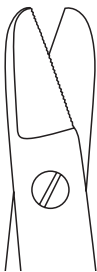

12,5 cm – 5"

14.24.22



12,5 cm – 5"

14.26.12



12,5 cm – 5"

14.26.22



12,5 cm – 5"

14.25.12



12,5 cm – 5"

14.25.22



12,5 cm – 5"

14.27.12



12,5 cm – 5"

14.27.22



Eine Schneide gezahnt
 One blade serrated
 Una hoja dentada
 Une lame dentelée
 Una lama dentellata



Drahtscheren
Wire Cutting Scissors
Tijeras para cortar alambre
Ciseaux coupe-fil
Forbici per fili d'acciaio

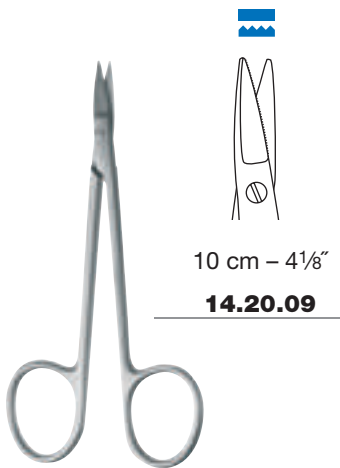

10 cm – 4 1/8"

14.20.09

Schuknecht



13 cm – 5 1/8"

14.20.10

Harvey

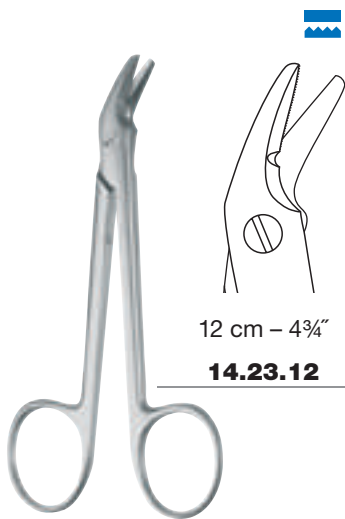

12 cm – 4 3/4"

14.23.12

Universal



12 cm – 4 3/4"

14.23.62

0,3 mm

0,8 mm

Universal "HM"



16 cm – 6 1/4"

14.23.66

0,8 mm

1,2 mm

Universal "HM"

"HM"
 Hartmetall
 Tungsten carbide
 Carburo de tungsteno
 Carbure de tungstène
 Carburo di tungsteno

max.
 Harte Drähte
 Hard wires
 Alambres duros
 Fils durs
 Fili duri

max.
 Weiche Drähte
 Soft wires
 Alambres blandos
 Fils mous
 Fili dolci

max.
 Eine Schneide gezahnt
 One blade serrated
 Una hoja dentada
 Une lame dentelée
 Una lama dentellata



Drahtscheren, Drahtkneifzangen
Wire Cutting Scissors, Wire Cutting Pliers
Tijeras para cortar alambre, Pinzas para cortar alambre
Ciseaux coupe-fil, Pincas coupe-fil
Forbici per fili d'acciaio, Tenaglie tagliafili



12 cm – 4¾"
14.26.72

“HM”



16 cm – 6¼"
14.28.68

“HM”



16 cm – 6¼"
14.29.68

“HM”

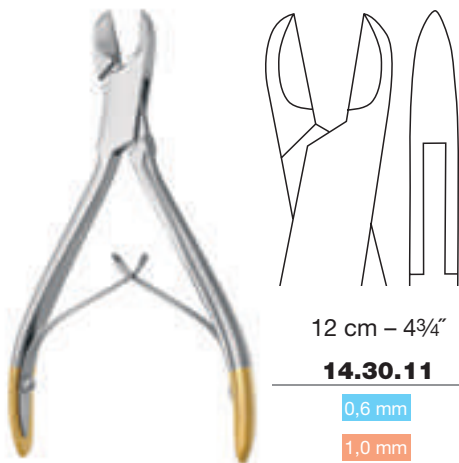

12 cm – 4¾"
14.30.11

0,6 mm
 1,0 mm

“HM”



13 cm – 5⅛"
14.30.13

1,2 mm
 1,6 mm

“HM”

“HM”
 Hartmetall
 Tungsten carbide
 Carburo de tungsteno
 Carbone de tungstène
 Carburo di tungsteno

max.
 Harte Drähte
 Hard wires
 Alambres duros
 Fils durs
 Fili duri

max.
 Weiche Drähte
 Soft wires
 Alambres blandos
 Fils mous
 Fili dolci

Eine Schneide gezahnt
 One blade serrated
 Una hoja dentada
 Une lame dentelée
 Una lama dentellata



Drahtkneifzangen
Wire Cutting Pliers
Pinzas para cortar alambre
Pinces coupe-fil
Tenaglie tagliafili

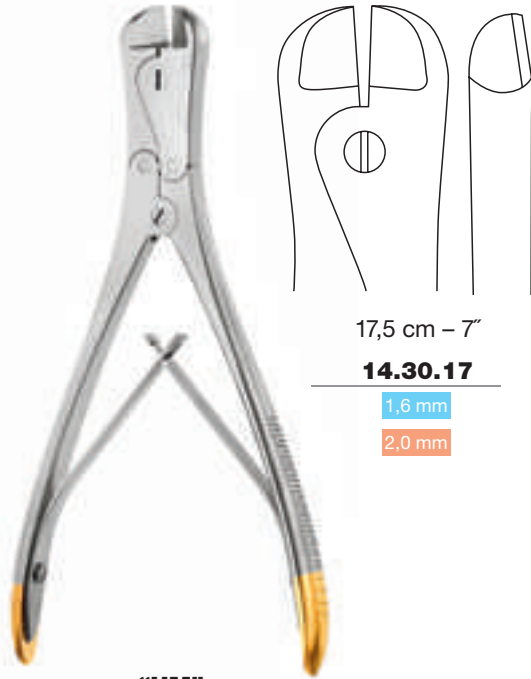

17,5 cm – 7"

14.30.17

1,6 mm

2,0 mm

"HM"



19 cm – 7½"

14.30.28

1,5 mm

2,0 mm



15 cm – 6"

14.30.65

1,5 mm

2,0 mm

"HM"



16 cm – 6¼"

14.30.76

1,5 mm

2,0 mm

"HM"
 Hartmetall
 Tungsten carbide
 Carburo de tungsteno
 Carbure de tungstène
 Carburo di tungsteno

max.
 Harte Drähte
 Hard wires
 Alambres duros
 Fils durs
 Fili duri

max.
 Weiche Drähte
 Soft wires
 Alambres blandos
 Fils mous
 Fili dolci



Drahtkneifzangen
Wire Cutting Pliers
Pinzas para cortar alambre
Pinces coupe-fil
Tenaglie tagliafili



18,5 cm – 7¼"

76.45.47

1,6 mm



21,5 cm – 8½"

76.45.43

2,5 mm

"HM"



23 cm – 9"

76.45.73

2,5 mm

"HM"

"HM"
 Hartmetall
 Tungsten carbide
 Carburo de tungsteno
 Carbure de tungstène
 Carburato di tungsteno

max.
 Harte Drähte
 Hard wires
 Alambres duros
 Fils durs
 Fili duri



Drahtkneifzange
Wire Cutting Pliers
Pinza para cortar alambre
Pince coupe-fil
Tenaglia tagliafilii

Kunststoffbacken halten den Draht nach dem Durchtrennen in der Zange fest.

Plastic inserts hold wire piece after being cut.

Mordazas de plástico retienen el alambre después del corte.

Mors en plastique tiennent le fil après couper.

Le guance di plastica sostengono il filo nel morso della pinza dopo il taglio.



Easy Cut "HM"



20 cm – 8"

76.45.85

1.8 mm

76.45.85

Drahtkneifzange mit auswechselbaren Hartmetallschneiden, inkl. Service-Set (76.45.86).

Inhalt Service-Set:

Ersatzschneiden "HM" (Paar) 76.45.87

Kunststoffbacken (Paar) 76.45.88

Schrauben (4 Stück) 76.45.89

Schraubendreher 76.45.90

Wire cutting pliers with exchangeable TC edges, incl. service set (76.45.86).

Contents of service set:

Replacement TC edges (pair) 76.45.87

Plastic inserts (pair) 76.45.88

Screws (4 pieces) 76.45.89

Screwdriver 76.45.90

Pinza para cortar alambre con hojas intercambiables de tungsteno, incl. set de servicio (76.45.86).

Contenido del set de servicio:

Hojas de tungsteno de repuesto (par) 76.45.87

Hojas de plástico (par) 76.45.88

Tornillos (4 piezas) 76.45.89

Destornillador 76.45.90

Pince coupe-fil avec lames en tungstène interchangeables, set de service inclut (76.45.86).

Contenu du set de service:

Lames de rechange en tungstène (paire) 76.45.87

Mors en plastique (4 pièces) 76.45.88

Vis (paire) 76.45.89

Tournevis 76.45.90

Tenaglia tagliafilii con lame intercambiabili, completa di set di servizio (76.45.86).

Contenuto del set di servizio:

Lame TC (paio) 76.45.87

Guance di plastica (4 pezzi) 76.45.88

Viti (paio) 76.45.89

Cacciavite 76.45.90

"HM"

Hartmetall
 Tungsten carbide
 Carburo de tungsteno
 Carbure de tungstène
 Carburo di tungsteno

max.

Harte Drähte
 Hard wires
 Alambres duros
 Fils durs
 Fili duri



Drahtkneifzangen
Wire Cutting Pliers
Pinzas para cortar alambre
Pinces coupe-fil
Tenaglie tagliafili

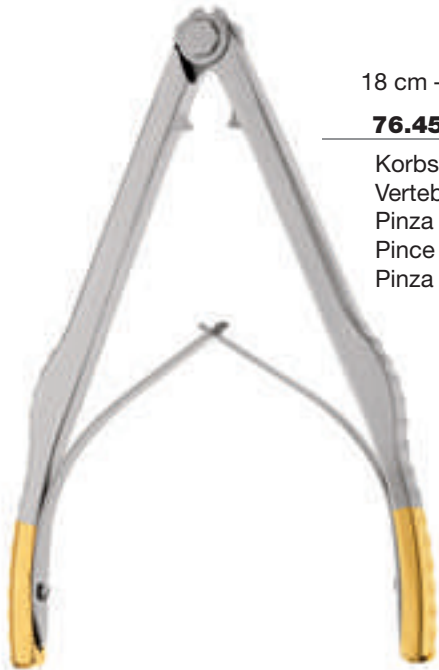

18 cm – 7 1/8"

76.45.55

Korbschneider
 Vertebral cutting forceps
 Pinza cortante vertebral
 Pince coupante vertébrale
 Pinza tagliante vertebrale

Harms "HM"



Kunststoffbacken halten den Draht nach dem Durchtrennen in der Zange fest
 Plastic inserts hold wire piece after being cut
 Mordazas de plástico retienen el alambre después del corte
 Mors en plastique tiennent le fil après couper
 Le guance di plastica sostengono il filo nel morso della pinza dopo il taglio



18 cm – 7 1/8"

76.45.60

1,6 mm

2,0 mm

"HM"

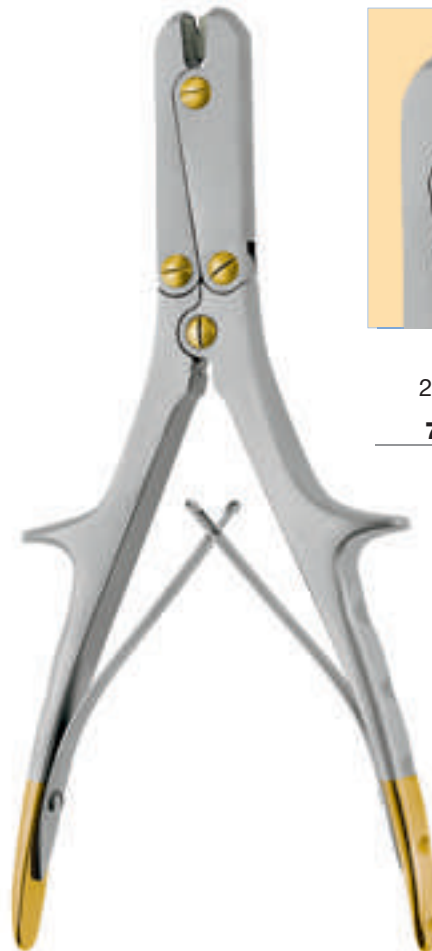

25 cm – 10"

76.45.75

3,0 mm

Goliath "HM"

"HM"
 Hartmetall
 Tungsten carbide
 Carburo de tungsteno
 Carbure de tungstène
 Carburo di tungsteno

max.
 Harte Drähte
 Hard wires
 Alambres duros
 Fils durs
 Fili duri

max.
 Weiche Drähte
 Soft wires
 Alambres blandos
 Fils mous
 Fili dolci



Drahtkneifzangen
Wire Cutting Pliers
Pinzas para cortar alambre
Pinces coupe-fil
Tenaglie tagliafili



26 cm – 10¼"
76.45.79
 3,0 mm



45 cm – 17¾"
76.45.80
 6,0 mm

1:4



57,5 cm – 22½"
76.45.81
 6,35 mm



Griffe demontierbar
 Handles dismantable
 Manchos desmontables
 Manches démontables
 Manici smontabili

1:4

max.
 Harte Drähte
 Hard wires
 Alambres duros
 Fils durs
 Fili duri

ORTHOPAEDICS

IMPLANTS AND INSTRUMENTS

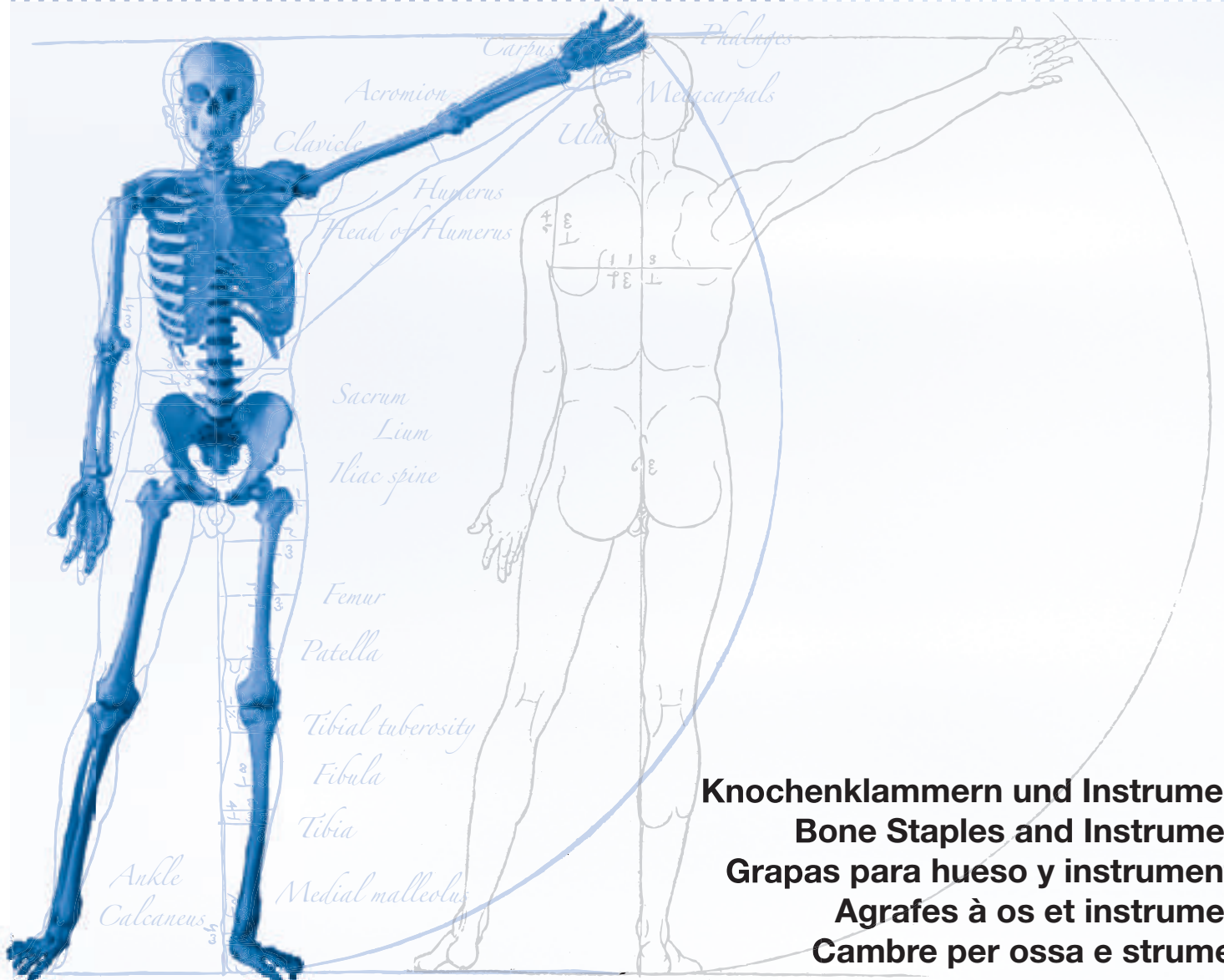

Knochenklammern und Instrumente
Bone Staples and Instruments
Grapas para hueso y instrumentos
Agrafes à os et instruments
Cambre per ossa e strumenti



Knochenklammern
Bone Staples
Grapas para hueso
Agrafes à os
Agrafes per ossa

	a	b	Ø	
	76.09.15	8,7 mm	16 mm	2 mm
	76.09.16	8,7 mm	19 mm	2 mm
	76.09.17	8,7 mm	22 mm	2 mm
	76.09.18	8,7 mm	25 mm	2 mm

	a	b	Ø	
	76.09.25	22 mm	19 mm	2,5 mm
	76.09.26	16 mm	19 mm	2,5 mm
	76.09.28	22 mm	19 mm	1,5 mm
	76.09.29	16 mm	19 mm	1,5 mm

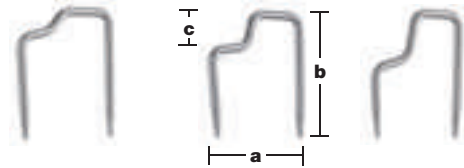

	a	b	c
76.09.20	24 mm	33 mm	4,8 mm
76.09.21	24 mm	33 mm	9,5 mm
76.09.22	24 mm	33 mm	14,0 mm

**Hernandez-Ros**

19 cm – 7½"

76.09.09

Klammerheber
 Staple extractor
 Extractor de grapas
 Extracteur d'agrafes
 Estrattore di agrafes

**Hernandez-Ros**

15,5 cm – 6⅛"

76.09.08

Klammerstößel
 Staple driver
 Impactor de grapas
 Pilon pour agrafes
 Impattatore per agrafes

**Hernandez-Ros**

16 cm – 6¼"

76.09.07

Klammerhalter
 Staple holder
 Porta-grapas
 Porte-agrafes
 Porta agrafes



Knochenklammern, Einschlaginstrumente
Bone Staples, Impactors
Grapas para hueso, impactores
Agrafes à os, impacteurs
Agrafes per ossa, impattatori

Einschlaginstrument
 Impactor
 Impactor
 Impacteur
 Introduttore



25 cm – 10"

76.09.72

für, for, para, pour, per
76.09.40/41/42
76.09.50/51/52/53

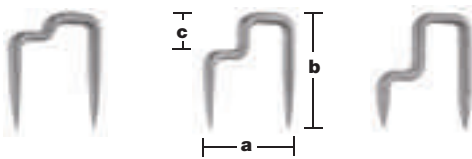

	a	b	c
76.09.40	24 mm	30 mm	5 mm
76.09.41	24 mm	30 mm	10 mm
76.09.42	24 mm	30 mm	15 mm



Blount

	a	b
76.09.50	9,5 mm	22 mm
76.09.51	16,0 mm	22 mm
76.09.52	22,0 mm	22 mm
76.09.53	28,0 mm	22 mm

Einschlaginstrument
 Impactor
 Impactor
 Impacteur
 Introduttore



25 cm – 10"

76.09.70

für, for, para, pour, per
76.09.45/46/47

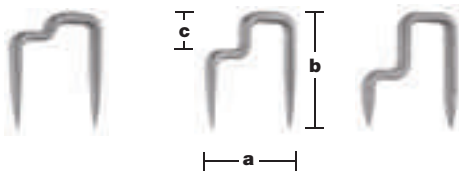

	a	b	c
76.09.45	24 mm	35 mm	5 mm
76.09.46	24 mm	40 mm	10 mm
76.09.47	24 mm	45 mm	15 mm

the art of surgery

Weitere MEDICON-Produkte finden Sie in unserem Hauptkatalog.

You will find further MEDICON products in our main catalogue.

Más productos de MEDICON se encuentra en nuestro catálogo general.

Vous trouverez d'autres produits MEDICON dans notre catalogue général.

Altri prodotti MEDICON si trovano nel nostro catalogo generale.

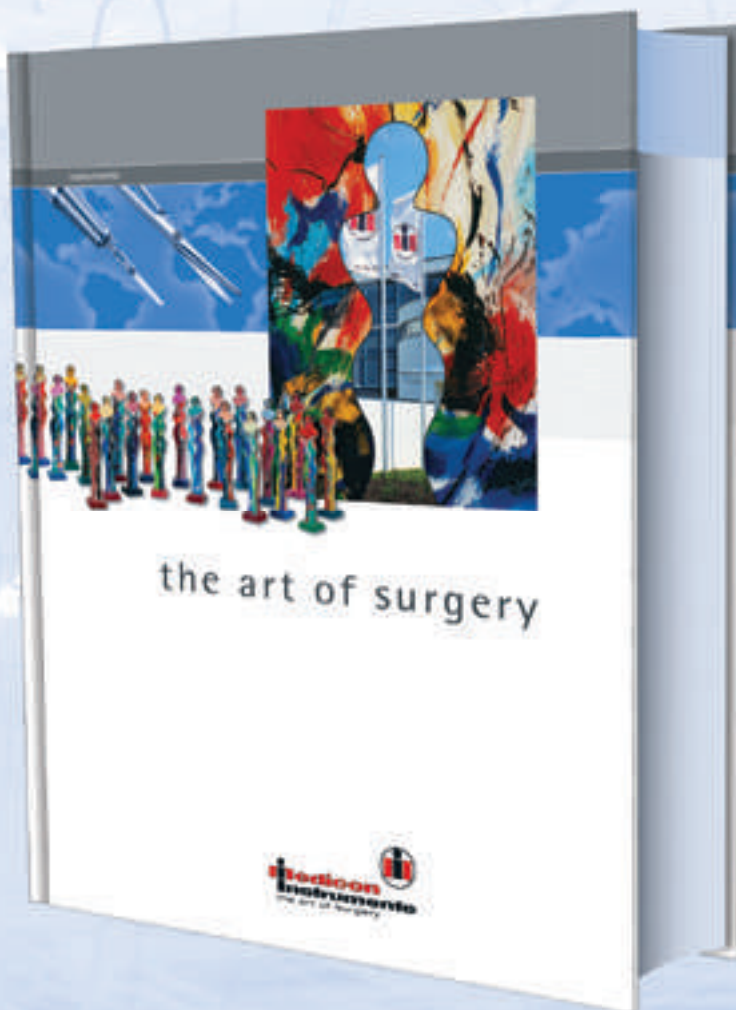

450.00.03

ORTHO PAEDICS

IMPLANTS AND INSTRUMENTS

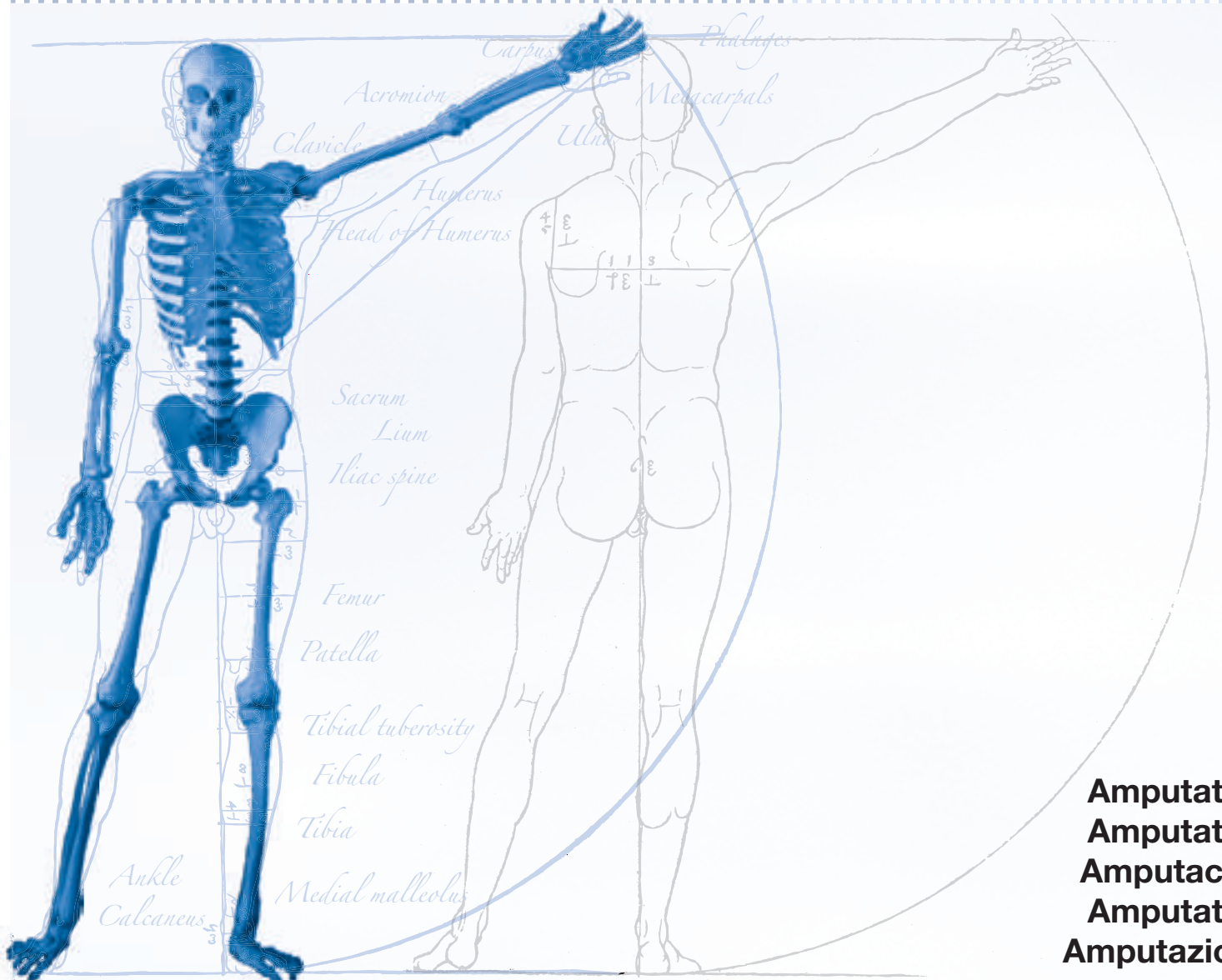

**Amputation
Amputation
Amputación
Amputation
Amputazione**



Resektionsmesser, Amputationsmesser
Resection Knives, Amputation Knives
Cuchillos para resección, Cuchillos para amputación
Couteaux à résection, Couteaux à amputation
Coltelli per resezione, Coltelli per amputazione

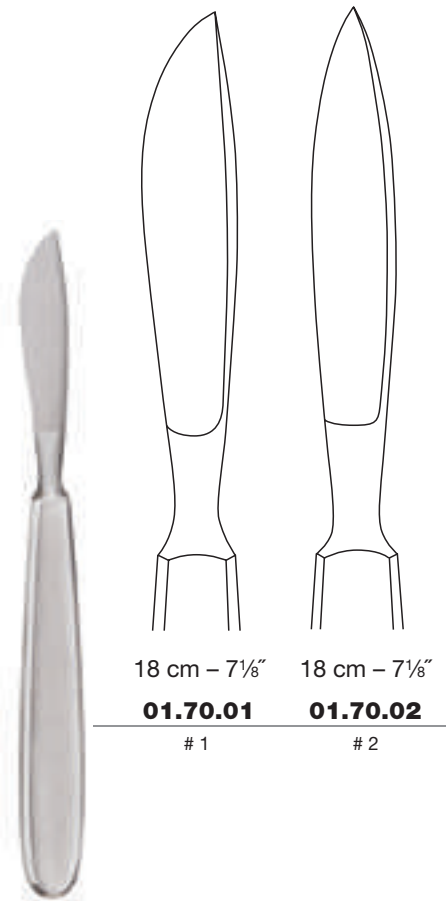

18 cm – 7 $\frac{1}{8}$ "

01.70.01

1

18 cm – 7 $\frac{1}{8}$ "

01.70.02

2

Langenbeck

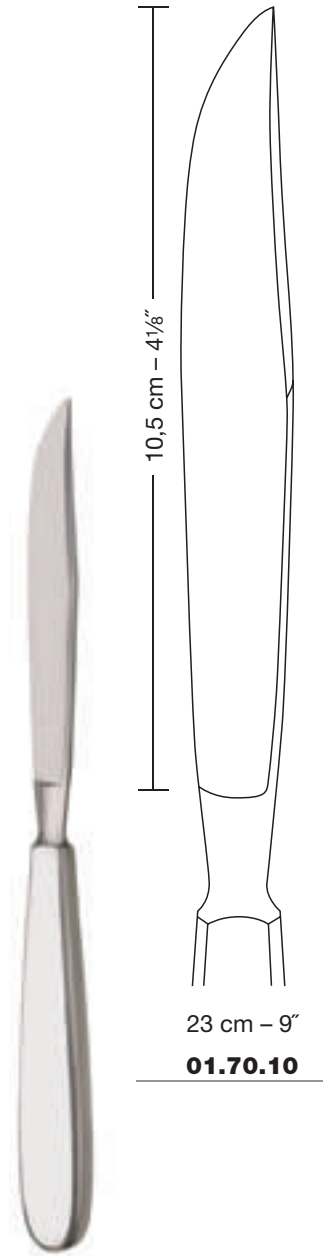

10,5 cm – 4 $\frac{1}{8}$ "

23 cm – 9"

01.70.10

Liston



Resektionsmesser, Amputationsmesser
Resection Knives, Amputation Knives
Cuchillos para resección, Cuchillos para amputación
Couteaux à résection, Couteaux à amputation
Coltelli per resezione, Coltelli per amputazione

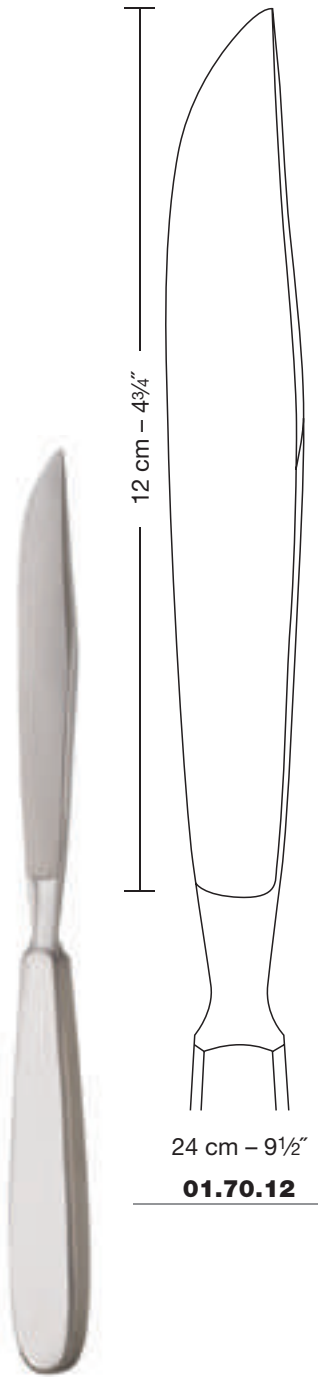

24 cm - 9 1/2"
01.70.12

Langenbeck

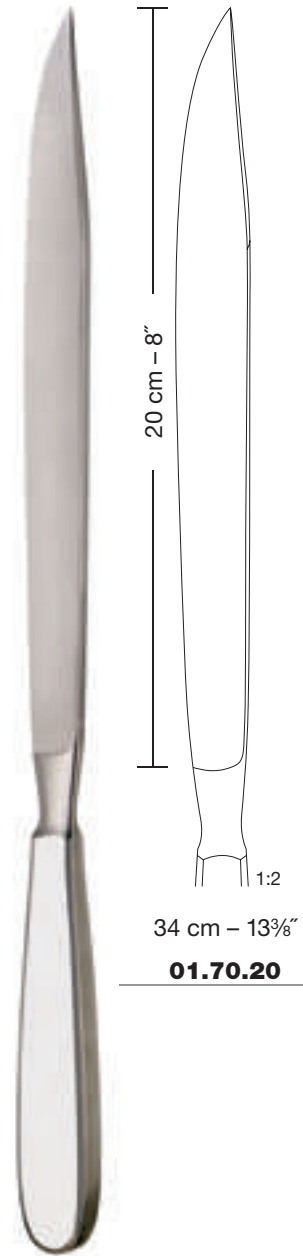

34 cm - 13 3/8"
01.70.20

Liston



Amputationsmesser
Amputation Knives
Cuchillos para amputación
Couteaux à amputation
Coltelli per amputazione

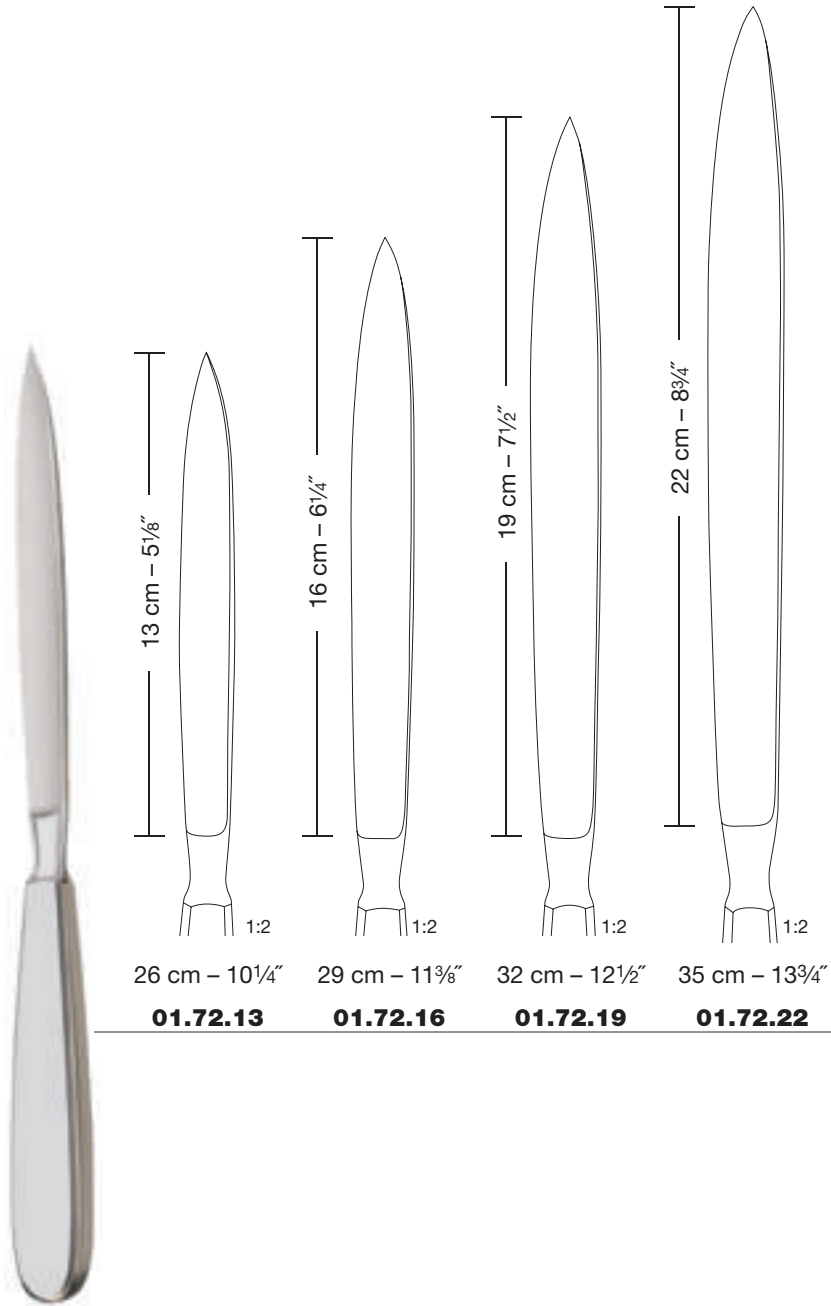



Amputationsmesser
Amputation Knives
Cuchillos para amputación
Couteaux à amputation
Coltelli per amputazione

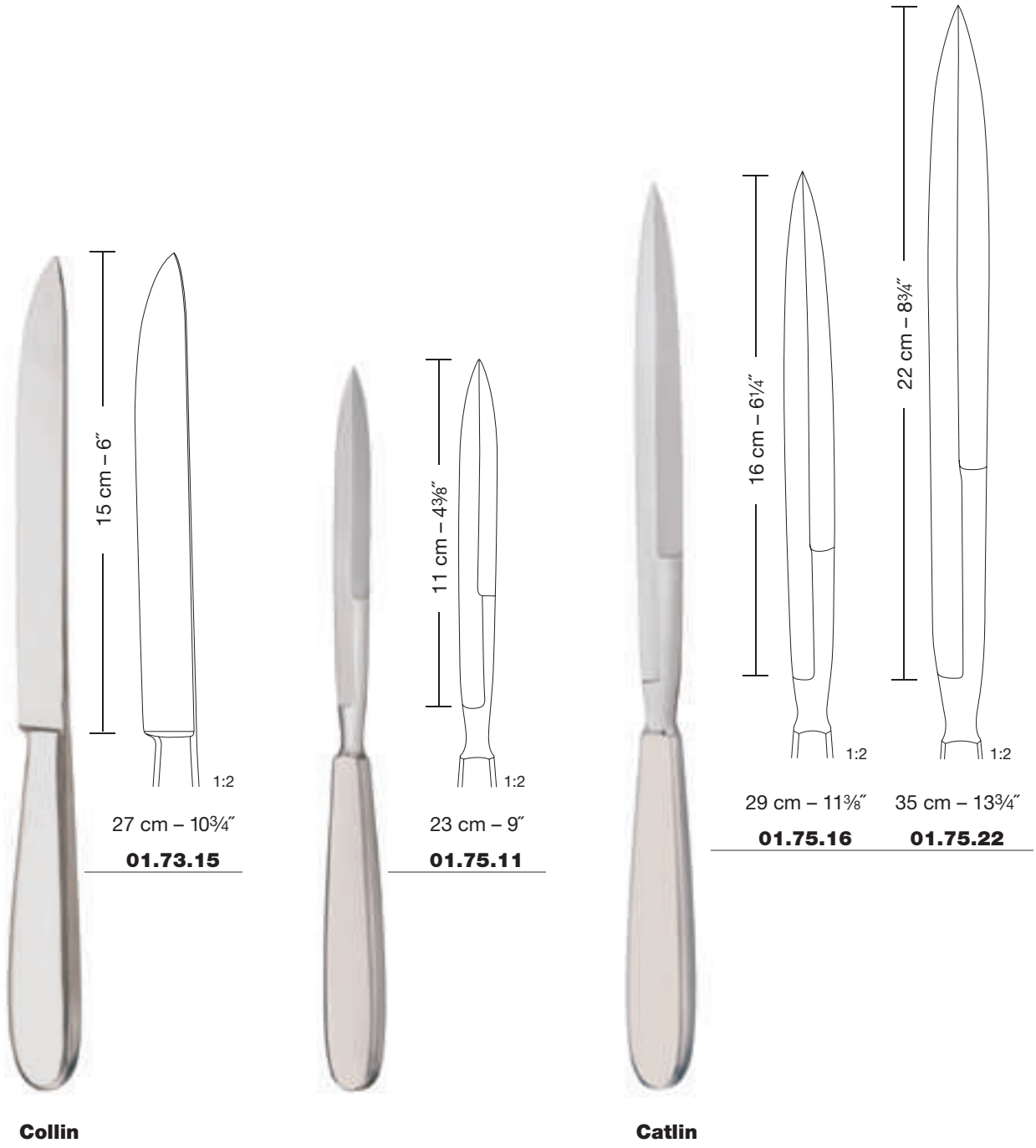

Collin

Catlin



Stichsägen, Amputationssägen
Compass Saws, Amputation Saws
Sierras de calar, Sierras de amputación
Scies à guichet, Scies à amputation
Seghe a coda di topo, Seghe per amputazione



17,5 cm – 7"

77.02.14



23 cm – 9"

77.02.23

Langenbeck

77.04.70

Ersatzsägeblatt
 Spare blade
 Hoja de repuesto
 Lame de rechange
 Lama di ricambio



29 cm – 11³/₈"

77.04.29

1:3

Satterlee

12 mm 18 mm

77.05.62 77.05.68

Ersatzsägeblätter
 Spare blades
 Hojas de repuesto
 Lames de rechange
 Lama di ricambio



35 cm – 13³/₄"

77.05.35

komplett mit:
 complete with:
 completo con:
 complet avec:
 completo con:

77.05.62 + 77.05.68

1:3

Charrière



Amputationssägen
Amputation Saws
Sierras de amputación
Scies à amputation
Seghe per amputazione



4 mm 6 mm 8 mm
77.05.74 77.05.76 77.05.78

Ersatzsägeblätter
 Spare blades
 Hojas de repuesto
 Lames de rechange
 Lame di ricambio

42 cm – 16½"

77.05.39

komplett mit:
 complete with:
 completo con:
 complet avec:
 completo con:
 77.05.74 + 77.05.76 + 77.05.78

Bier



12 mm 18 mm
77.05.92 77.05.98

Ersatzsägeblätter
 Spare blades
 Hojas de repuesto
 Lames de rechange
 Lame di ricambio

38 cm – 15"

77.05.40

komplett mit:
 complete with:
 completo con:
 complet avec:
 completo con:
 77.05.92 + 77.05.98

Rust



Amputations-Retraktor
Amputation Retractor
Retractor de amputación
Rétracteur à amputation
Protettore per amputazione



77.09.50

Percy

ORTHO PAEDICS

IMPLANTS AND INSTRUMENTS

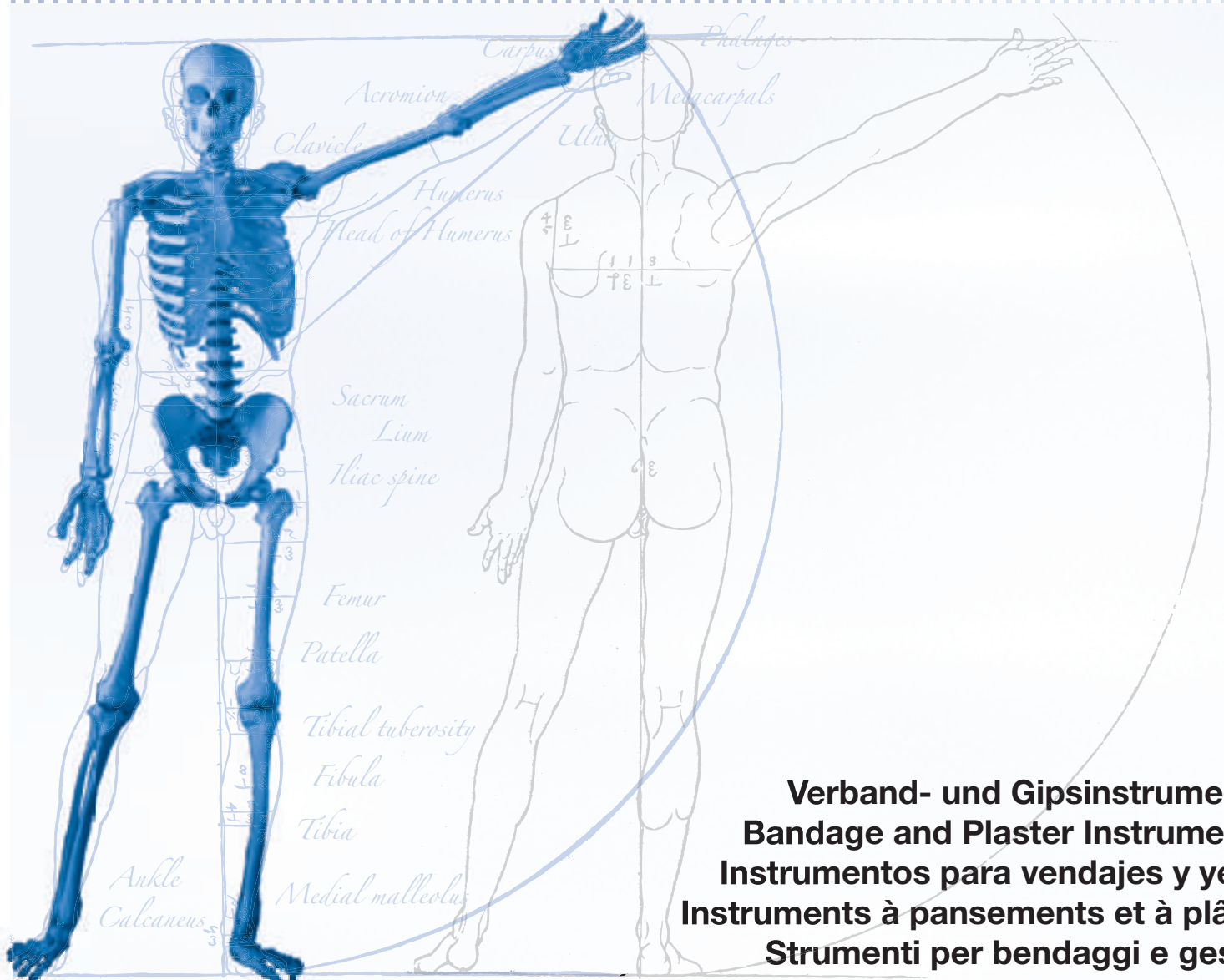

Verband- und Gipsinstrumente
Bandage and Plaster Instruments
Instrumentos para vendajes y yeso
Instrumenti à pansements et à plâtre
Strumenti per bendaggi e gesso



Verbandscheren
Bandage Scissors
Tijeras para vendajes
Ciseaux à pansements
Forbici per bendaggi

mit großem Ring
with big ring
con anillo grande
avec grands anneaux
con anello grande

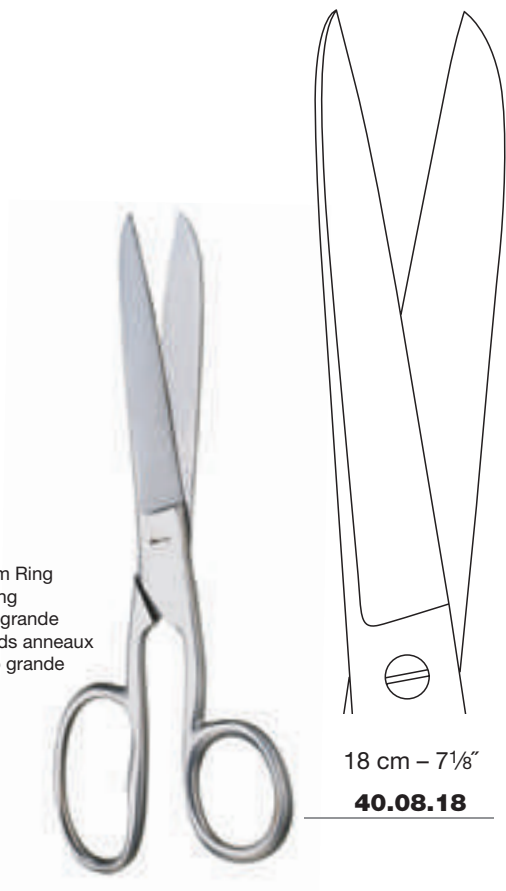

18 cm – 7 1/8"

40.08.18

Smith



14 cm – 5 1/2"

40.20.84

Knowles

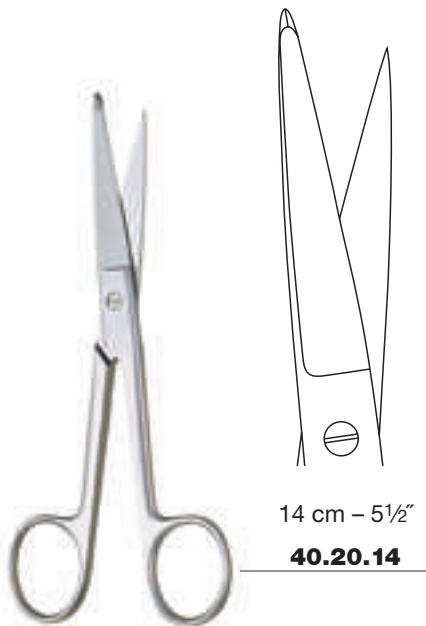

14 cm – 5 1/2"

40.20.14

Knowles

Verbandscheren
Bandage Scissors
Tijeras para vendajes
Ciseaux à pansements
Forbici per bendaggi

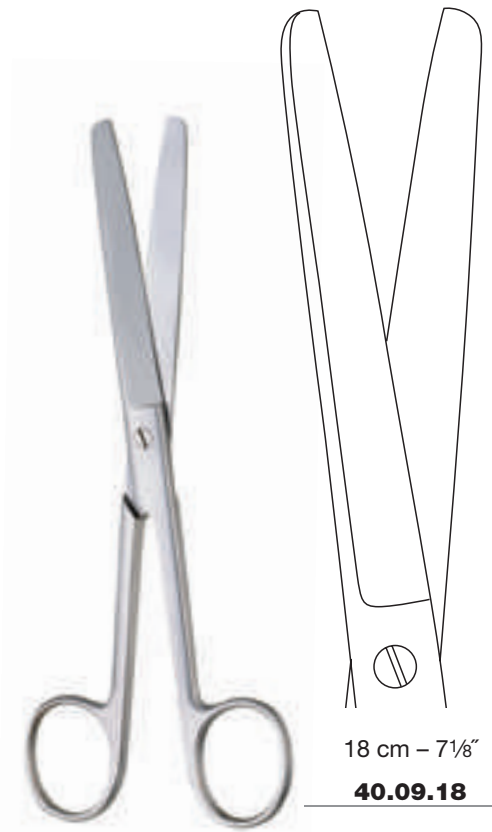

18 cm - 7 1/8"

40.09.18

Lange



24 cm - 9 1/2"

40.13.24

Lorenz



Verbandscheren
Bandage Scissors
Tijeras para vendajes
Ciseaux à pansements
Forbici per bendaggi

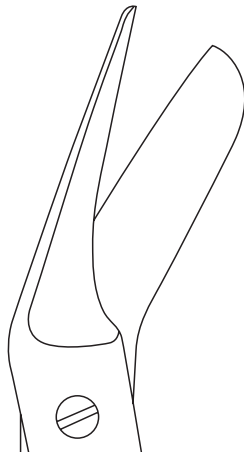

17 cm - 6¾"

standard

40.24.17

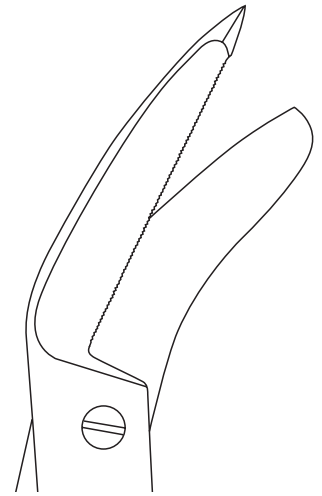

16 cm - 6¼"

standard

40.25.96

supercut

240.25.96

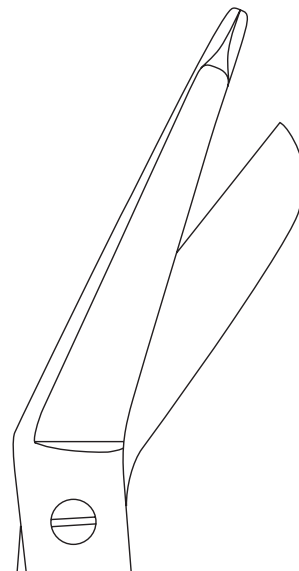
Lister-Excentric

20 cm - 8"

standard

40.26.20

supercut

240.26.20

"HM"

40.26.80

mit großem Ring
 with big ring
 con anillo grande
 avec grands anneaux
 con anello grande

Lister



Verbandscheren
Bandage Scissors
Tijeras para vendajes
Ciseaux à pansements
Forbici per bendaggi

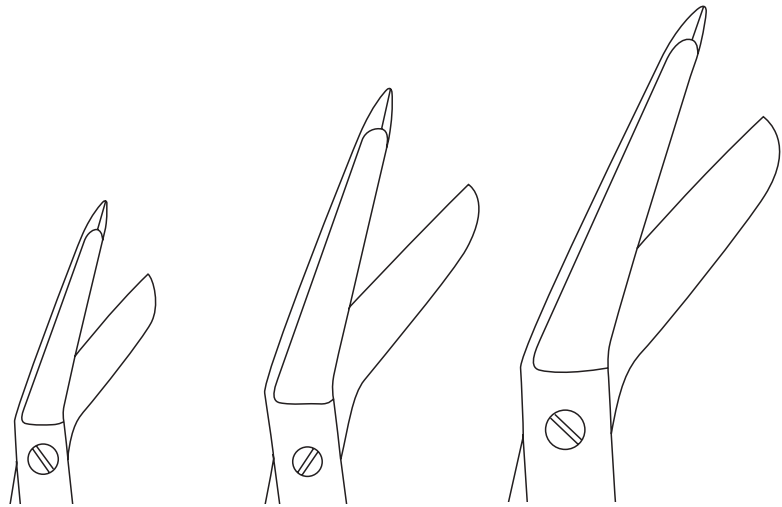

9 cm – 3½"

11,5 cm – 4½"

14 cm – 5½"

standard	40.25.09	40.25.11	40.25.14
supercut			240.25.14
"HM"			40.25.64



Lister

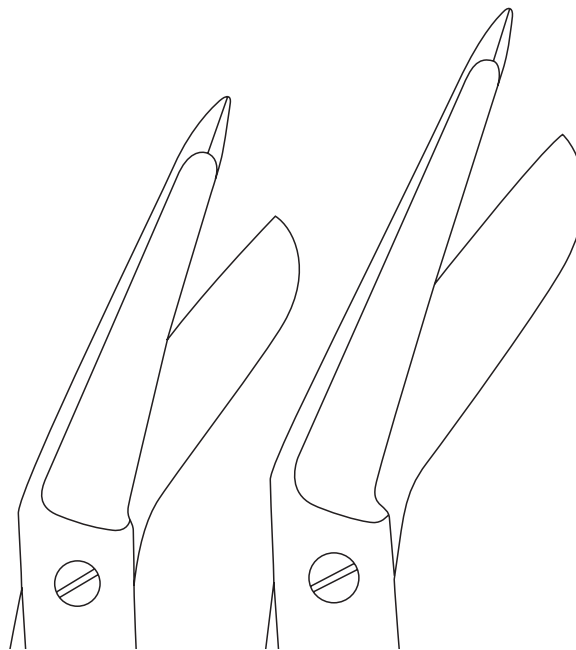

18 cm – 7⅛"

20 cm – 8"

standard	40.25.18	40.25.20
supercut	240.25.18	240.25.20
"HM"	40.25.68	40.25.70



Verbandscheren
Bandage Scissors
Tijeras para vendajes
Ciseaux à pansements
Forbici per bendaggi



Esmarch

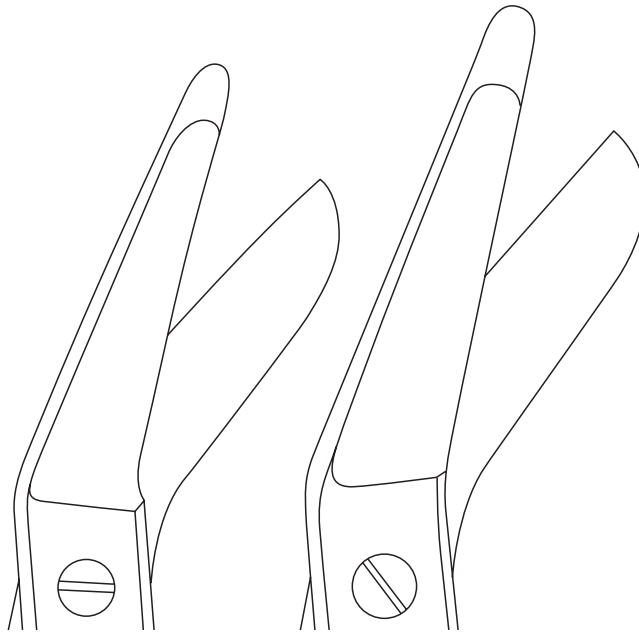

20 cm - 8"

22 cm - 8¾"

standard

40.31.20

40.31.22

supercut

240.31.20



Bergmann

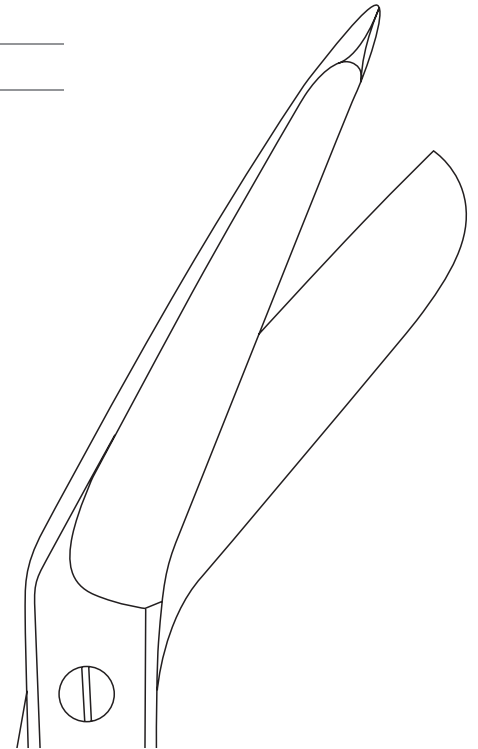

23 cm - 9"

standard

40.33.23



Verbandscheren
Bandage Scissors
Tijeras para vendajes
Ciseaux à pansements
Forbici per bendaggi



24 cm - 9½"

standard 40.41.23

Brun's



24 cm - 9½"

standard	40.41.24
supercut	240.41.24
"HM"	40.41.74

Brun's



Verbandscheren
Bandage Scissors
Tijeras para vendajes
Ciseaux à pansements
Forbici per bendaggi



15 cm - 6"

40.47.14

19 cm - 7½"

40.47.18

Universal

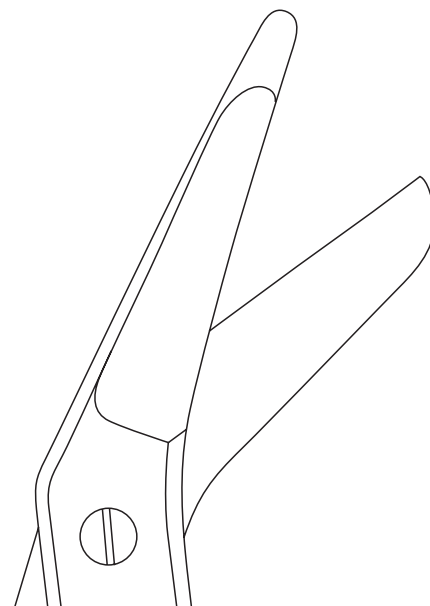

21 cm - 8¼"

40.47.21

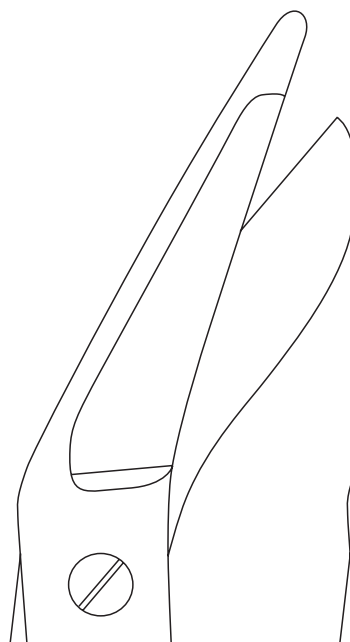

23 cm - 9"

40.49.23

Seutin

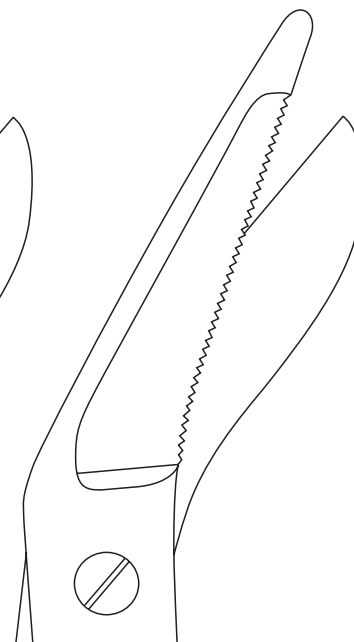

23 cm - 9"

40.53.22

Medicon



Eine Schneide gezahnt
One blade serrated
Una hoja dentada
Une lame dentelée
Una lama dentellata



Gipsscheren
Plaster Shears
Cizallas para vendajes
Cisailles à plâtre
Cesoie per bendaggi

40.53.73

Ersatzklinge für 40.53.23
 Spare blade for 40.53.23
 Hoja de repuesto para 40.53.23
 Lame de rechange pour 40.53.23
 Lama di ricambio per 40.53.23



23 cm – 9"

40.53.23

Stille

40.55.70

Ersatzklinge für 40.55.20
 Spare blade for 40.55.20
 Hoja de repuesto para 40.55.20
 Lame de rechange pour 40.55.20
 Lama di ricambio per 40.55.20



20 cm – 8"

40.55.20

Stille-Mini



Gipsscheren
Plaster Shears
Cizallas para yeso
Cisailles à plâtre
Cesoie per gesso

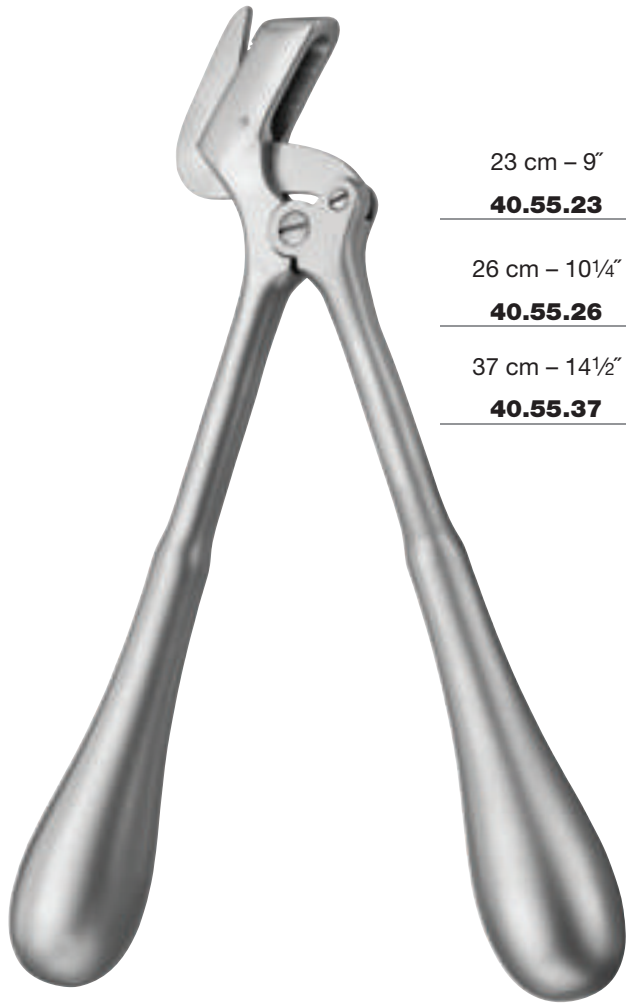

23 cm – 9"

40.55.23

26 cm – 10¼"

40.55.26

37 cm – 14½"

40.55.37**Stille****40.56.77**

Ersatzklinge für 40.56.37

Spare blade for 40.56.37

Hoja de repuesto para 40.56.37

Lame de rechange pour 40.56.37

Lama di ricambio per 40.56.37

37 cm – 14½"

40.56.37**Stille**

Ersatzklingen
 Spare blades
 Hojas de repuesto
 Lames de rechanges
 Lama di ricambio

für
 for
 para
 pour
 per

40.55.73

40.55.23

40.55.76

40.55.26

40.55.77

40.55.37



**Gipsmesser
Plaster Knives
Cuchillos para yeso
Couteaux à plâtre
Coltelli per gesso**

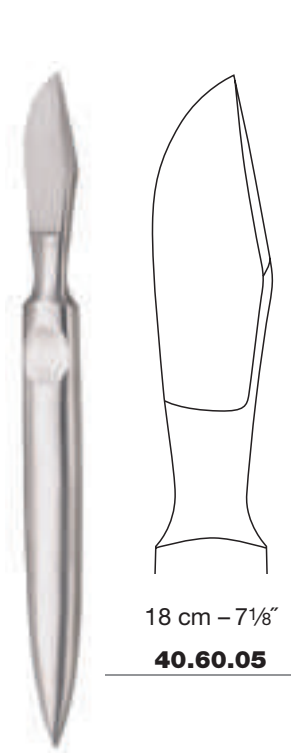

18 cm - 7 1/8"

40.60.05

Esmarch

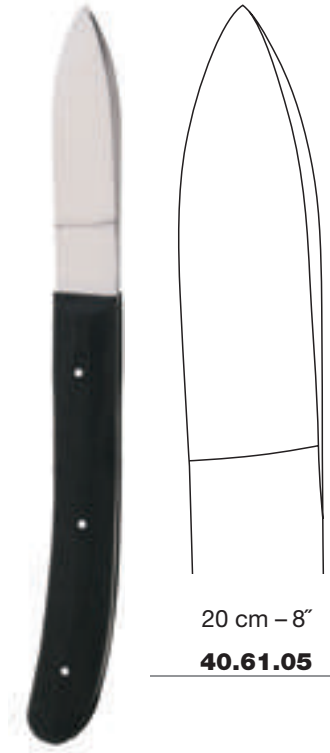

20 cm - 8"

40.61.05

Hopkins

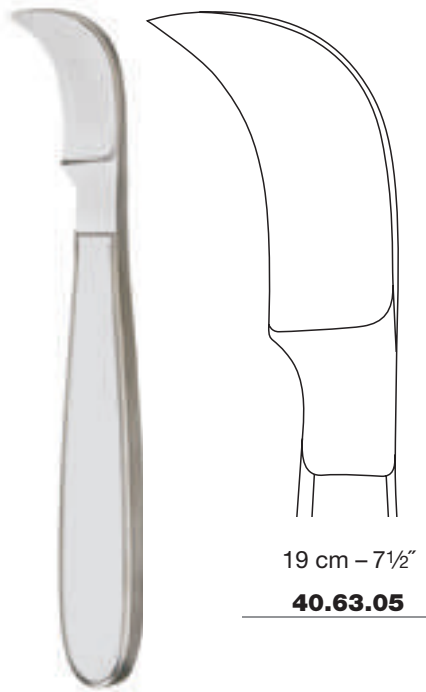

19 cm - 7 1/2"

40.63.05

Reiner



Gipssäge
Plaster saw
Sierra para yeso
Scie à plâtre
Sega per gesso

15 cm - 6"

40.66.05

Engel



Gipsspreizer, Gipsabreißzangen
Plaster Spreaders, Plaster Cast Breakers
Pinzas para abrir vendajes, Pinzas para arrancar vendajes enyesados
Ecarteurs à plâtre, Pincas pour arracher les plâtres
Allargagessi, Pinze strappagessi

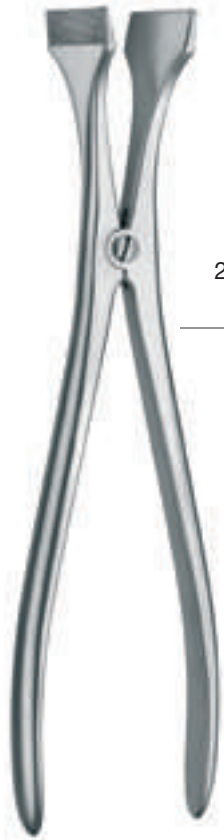

27 cm – 10¾"

40.70.27

Hennig



23 cm – 9"

40.75.23

Mod. USA



18 cm – 7⅛"

40.81.18

27,5 cm – 10¾"

40.81.24

Wolff-Böhler

ORTHOPAEDICS

IMPLANTS AND INSTRUMENTS

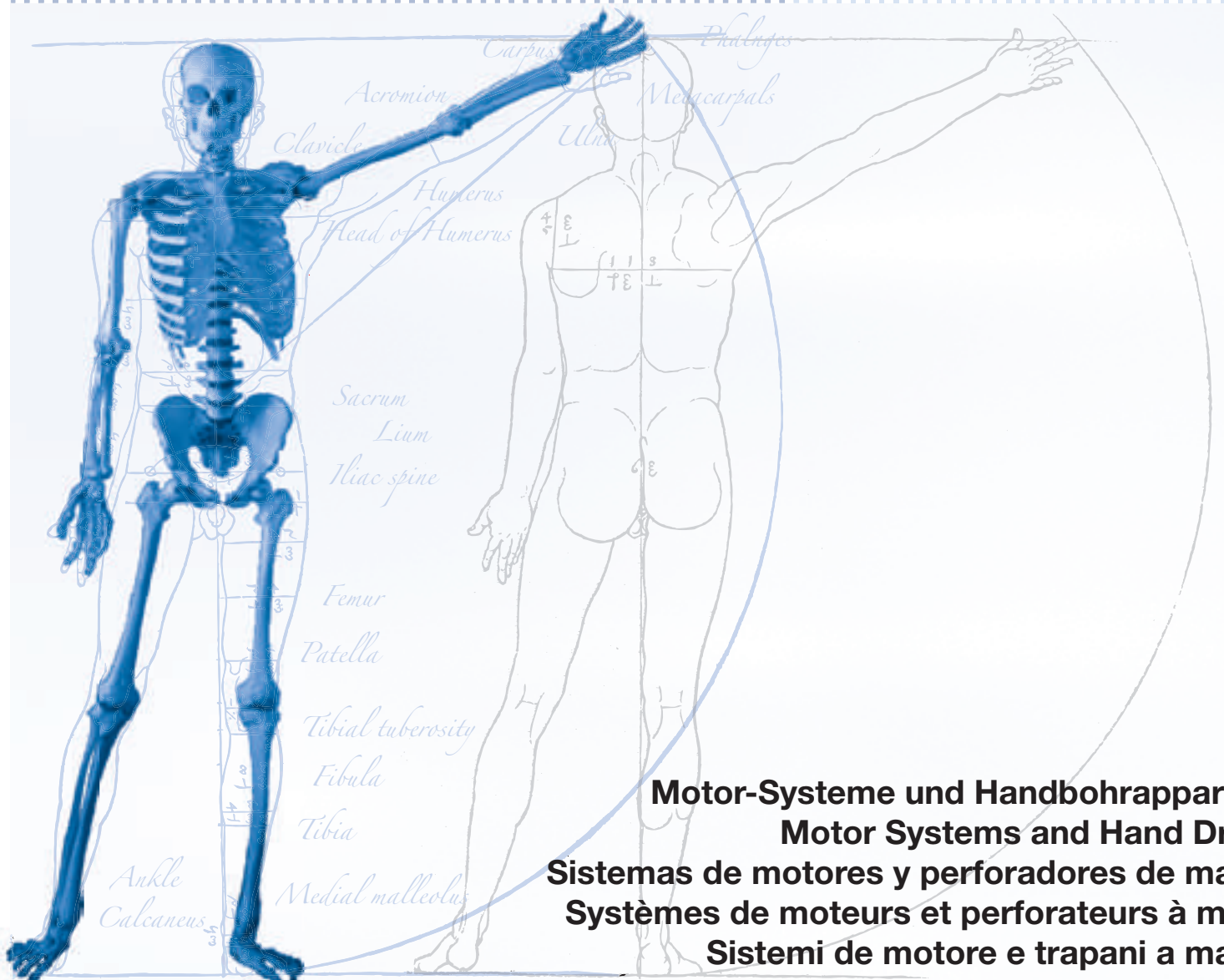

Motor-Systeme und Handbohrapparate
Motor Systems and Hand Drills
Sistemas de motores y perforadores de mano
Systèmes de moteurs et perforateurs à main
Sistemi di motore e trapani a mano



Elektrische oszillierende Verbandsäge
Electric Oscillating Plaster Saw
Sierra eléctrica oscilante para vendajes
Scie électrique oscillante à plâtre
Sega elettrica oscillante per gesso



TIGER



120 Volt

40.50.81

230 Volt

40.50.82

Satz komplett im Kunststoffkoffer, bestehend aus:
 Set complete in plastic case, consisting of:
 Juego completo en maletín de plástico, compuesto de:
 Jeu complet en valise plastique, se composant de:
 Serie completa in valigetta di plastica, composta da:

Verbandsäge
 Plaster saw
 Sierra para vendajes
 Scie à plâtre
 Sega per gesso

40.50.65
 1 Sägeblatt Ø 50 mm
 1 Saw blade Ø 50 mm
 1 Hoja de sierra Ø 50 mm
 1 Lame de scie Ø 50 mm
 1 Lama da sega Ø 50 mm

40.50.69
 1 Sägeblatt Ø 65 mm
 1 Saw blade Ø 65 mm
 1 Hoja de sierra Ø 65 mm
 1 Lame de scie Ø 65 mm
 1 Lama da sega Ø 65 mm

40.50.71
 1 Paar Gabelschlüssel
 1 Pair of wrenches
 1 Par de llaves
 1 Paire de clés
 1 Paio di chiavi

Ø 50 mm

40.50.65

Sägeblatt für Kunststoff- und Fiberglas-Hartverbände
 Saw blade for synthetic and fibre-glass dressings
 Hoja de sierra para vendajes sintéticos y fibra de vidrio
 Lame de scie pour plâtres durs synthétiques et en résine
 Lama da sega per gesso duro in sintetico e fibra di vetro



Ø 65 mm

40.50.69

Sägeblatt für Naturgipsverband
 Saw blade for plaster dressing
 Hoja de sierra para vendajes de yeso natural
 Lame de scie pour bandage en plâtre naturel
 Lama da sega per bendaggi in gesso naturale

**40.50.71**

Zubehör siehe Seite 278 + 279
 Accessories please see page 278 + 279
 Accesorios adicionales vea la página 278 + 279
 Accessoires voir page 278 + 279
 Accessori vedi pagina 278 + 279



Elektrische oszillierende Verbandsäge
Electric Oscillating Plaster Saw
Sierra eléctrica oscilante para vendajes
Scie électrique oscillante à plâtre
Sega elettrica oscillante per gesso



Vorteile:

- ▶ Robuste Konstruktion
- ▶ Hohe Belastbarkeit im Dauerbetrieb
- ▶ Vibrationsarm
- ▶ Automatischer Überlastungsschutz
- ▶ Wartungsfrei
- ▶ Geringes Gewicht
- ▶ Ergonomisches Handling
- ▶ Schwingungen sind stufenlos regulierbar
- ▶ Motorlagerung geschützt gegen Verbandstoffstaub

Advantages:

- ▶ Solid construction
- ▶ High capacity during permanent use
- ▶ Low vibrations
- ▶ Automatic overload protection
- ▶ Maintenance free
- ▶ Low weight
- ▶ Ergonomic handling
- ▶ Continuously variable adjustment of oscillations
- ▶ Motor protected against dust of dressings

Ventajas:

- ▶ Construcción robusta
- ▶ Gran capacidad de carga, también en uso continuo
- ▶ Nivel de vibración reducido
- ▶ Protección automática contra sobrecarga
- ▶ Libre de mantenimiento
- ▶ Peso reducido
- ▶ Manejo ergonómico
- ▶ Oscilaciones regulables sin escalonamientos
- ▶ Motor protegido contra polvo de vendaje

Avantages:

- ▶ Construction robuste
- ▶ Capacité élevée pendant usage permanent
- ▶ Niveau de vibration réduit
- ▶ Protection automatique contre surcharge
- ▶ Demande pas d'entretien
- ▶ Poids réduit
- ▶ Ergonomique
- ▶ Réglables progressivement oscillations
- ▶ Moteur avec protection contre poussière de plâtre

Vantaggi:

- ▶ Costruzione robusta
- ▶ Elevata capacità alle sollecitazioni anche in uso continuo
- ▶ Ridotto livello di vibrazioni
- ▶ Protezione automatica contro sovraccarichi
- ▶ Senza manutenzione
- ▶ Peso ridotto
- ▶ Ergonomica
- ▶ Oscillazioni regolabili in modo continuo
- ▶ Motore protetto contro la polvere del gesso

Technische Daten:

230 Volt, 50 Hz oder 120 Volt, 60 Hz
 500 Watt
 6500-24000 Schwingungen pro Minute
 Anschlußkabel 5 m
 Doppelschutzisolierung
 Schutzklasse II
 Typ BF

Technical data:

230 Volt, 50 cycles or 120 Volt, 60 cycles
 500 Watt
 6500-24000 oscillations per minute
 Connecting cable 5 m
 Double insulated
 Safety classification II
 Typ BF

Especificaciones técnicas:

230 Voltios, 50 Hz o bien 120 Voltios, 60 Hz
 500 Vatios
 6500-24000 oscilaciones por minuto
 Cable de conexión eléctrico 5 m
 Aislamiento protector doble
 Clase de protección II
 Tipo BF

Caractéristiques techniques:

230 volt, 50 Hz ou 120 volt, 60 Hz
 500 watt
 6500-24000 oscillations par minute
 Câble d'alimentation de 5 m
 Double isolation
 Classe de protection II
 Type BF

Dati tecnici:

230 volt, 50 Hz o 120 volt, 60 Hz
 500 watt
 6500-24000 oscillazioni al minuto
 Cavo di connessione 5 m
 Doppio isolamento
 Classe protettiva II
 Tipo BF



Elektrische oszillierende Verbandsäge
Electric Oscillating Plaster Saw
Sierra eléctrica oscilante para vendajes
Scie électrique oscillante à plâtre
Sega elettrica oscillante per gesso

OSCILLO V



120 Volt

40.50.39

230 Volt

40.50.40

Satz komplett im Kunststoffkoffer, bestehend aus:
 Set complete in plastic case, consisting of:
 Juego completo en maletín de plástico, compuesto de:
 Jeu complet en valise plastique, se composant de:
 Serie completa in valigetta di plastica, composta da:

Verbandsäge
 Plaster saw
 Sierra para vendajes
 Scie à plâtre
 Sega per gesso

40.50.65
 1 Sägeblatt Ø 50 mm
 1 Saw blade Ø 50 mm
 1 Hoja de sierra Ø 50 mm
 1 Lame de scie Ø 50 mm
 1 Lama da sega Ø 50 mm

40.50.69
 1 Sägeblatt Ø 65 mm
 1 Saw blade Ø 65 mm
 1 Hoja de sierra Ø 65 mm
 1 Lame de scie Ø 65 mm
 1 Lama da sega Ø 65 mm

40.50.71
 1 Paar Gabelschlüssel
 1 Pair of wrenches
 1 Par de llaves
 1 Paire de clés
 1 Paio di chiavi

Ø 50 mm

40.50.65

Sägeblatt für Kunststoff- und Fiberglas-Hartverbände
 Saw blade for synthetic and fibre-glass dressings
 Hoja de sierra para vendajes sintéticos y fibra de vidrio
 Lame de scie pour platres durs synthétiques et en résine
 Lama da sega per gesso duro in sintetico e fibra di vetro

Ø 65 mm

40.50.69

Sägeblatt für Naturgipsverband
 Saw blade for plaster dressing
 Hoja de sierra para vendajes de yeso natural
 Lame de scie pour bandage en plâtre naturel
 Lama da sega per bendaggi in gesso naturale

Technische Daten:**Technical data:****Especificaciones técnicas:****Caracteristiques techniques:****Dati tecnici:**

10.000 – 19.000
 Schwingungen pro Minute
 Oscillations per minute
 Oscilaciones por minuto
 Oscillations par minute
 Oscillazioni al minuto

3 m
 Anschlußkabel
 Connecting cable
 Cable de conexión eléctrico
 Cable d'alimentation
 Cavo di connessione

230 V, 50 Hz
 120 V, 60 Hz
 210 W

**40.50.71**

Zubehör siehe Seite 278 + 279
 Accessories please see page 278 + 279
 Accesorios adicionales vea la página 278 + 279
 Accessoires voir page 278 + 279
 Accessori vedi pagina 278 + 279



Staubsauger für Gipssägen
Vacuum Cleaner for plaster saws
Aspirador para sierras de yeso
Aspirateur pour scies à plâtre
Aspiratore per seghe per gesso



120 V, 1100 W

40.50.45

230 V, 1100 W

40.50.46

für; for; para; pour; per:



Lieferumfang:

1 Staubsauger (ohne Gipssäge) inkl. Saugschlauch und Ständer für Saugschlauch sowie Ablageschale für Gipssäge, 1 Saugdüse für die Befestigung des Saugschlauchs an der Gipssäge, 1 HEPA Filter, 1 Duftstäbchen, 1 Papiersack

Content of delivery:

1 Vacuum cleaner (without plaster saw) incl. suction tube, support device for suction tube and support plate for plaster saw, 1 suction nozzle to connect the suction tube to the plaster saw, 1 HEPA filter, 1 perfume stick, 1 paper bag

Suministro:

1 Aspirador (sin sierra de yeso) incl. manguera de aspiración y soporte para la manguera, además una bandeja para depositar la sierra de yeso, 1 tobera aspiradora para la fijación de la manguera de aspiración a la sierra de yeso, 1 filtro HEPA, 1 bastoncillo perfumado, 1 saco de papel

Contenu de base:

1 Aspirateur (sans scie à plâtre) avec tuyau d'aspiration et support pour le tuyau d'aspiration et panier pour le rangement de la scie à plâtre, 1 buse d'aspiration pour la fixation du tuyau d'aspiration à la scie à plâtre, 1 filtre HEPA, 1 bâtonnet odorante, 1 sac papier

Fornitura composta da:

1 Aspiratore (senza sega per gesso) incl. tubo di aspirazione e supporto per il tubo come anche l'appoggio per sega per gesso, 1 ugello per l'applicazione del tubo d'aspirazione alla sega, 1 filtro HEPA, 1 bastoncino odorante, 1 sacchetto di carta

Technische Daten:

Technical data:

Especificaciones técnicas:

Caractéristiques techniques:

Dati tecnici:

0,3 micron	Filtrierung Filtration Filtración Filtration Filtrazione
12 l	Tankinhalt Tank capacity Capacidad del tanque Capacité de la cuve Capacità del cassone
150 cm	Höhe Height Altura Hauteur Altezza
12 kg	Gewicht Weight Peso Poids Peso

40.50.48

Service Set: 1 HEPA-Filter, 6 Papiersäcke, 6 Duftstäbchen

Service set: 1 HEPA-filter, 6 paper bags, 6 perfume sticks

Set servizio: 1 filtro HEPA, 6 sacos de papel, 6 bastoncillos perfumados

Set service: 1 filtre HEPA, 6 sacs en papier, 6 bâtonnets odorants

Set servizio: 1 filtro HEPA, 6 sacchetti di carta, 6 bastoncini odoranti



Zubehör
Accessories
Accesorios
Accessoires
Accessori

für; for; para; pour; per:



Sägeblätter für Kunststoff- u. Fiberglas-Hartverbände
Saw blades for synthetic and fibre-glass dressings
Hojas de sierra para vendajes sintéticos y fibra de vidrio
Lames de scie pour plâtres durs synthétiques et en résine
Lame da sega per gesso duro in sintetico e fibra di vetro



Ø 50 mm

40.50.65



Ø 65 mm

40.50.74

Exzentrische Begrenzungsscheibe für Sägeblätter
40.50.66 und 40.50.69

Eccentric disc to limit depth of cut for saw blades
40.50.66 and 40.50.69

Disco excéntrico para limitar la profundidad del corte para
sierras 40.50.66 y 40.55.69

Disque excentrique pour limiter la profondeur de la coupe,
pour lames de scie 40.50.66 et 40.50.69

Disco eccentrico per lame da seghe
40.50.66 e 40.50.69



Ø 65 mm

40.50.66

für; for; para; pour; per:



Sägeblätter für Naturgipsverband
 Saw blades for plaster dressing
 Hojas de sierra para vendajes de yeso natural
 Lames de scie pour bandage en plâtre naturel
 Lama da sega per bendaggi in gesso naturale



Ø 50 mm
40.50.68



40.50.72
 Segmentsägeblatt
 Segmental saw blade
 Hoja de sierra de segmento
 Lame de scie en segments
 Lama da sega segmento



Ø 65 mm
40.50.69



40.50.73
 Tiefensägeblatt
 Depth saw blade
 Hoja de sierra de profundidad
 Lame de scie pour profondeur
 Lama da sega per profondità

Gabelschlüssel für Sägeblattwechsel, Paar
 Wrenches for exchange of saw blades, pair
 Llaves de boca para cambiar la hoja de sierra, par
 Clés pour échanger la lame de scie, paire
 Chiavi per cambiare la lama per sega, paio



40.50.71



Elektrische oszillierende Verbandsäge
Electric Oscillating Plaster Saw
Sierra eléctrica oscilante para vendajes
Scie électrique oscillante à plâtre
Sega elettrica oscillante per gesso

OSCILLOCOMPACT



110 / 240 Volt

40.60.60

Satz komplett im Kunststoffkoffer, bestehend aus:
 Set complete in plastic case, consisting of:
 Juego completo en maletín de plástico, compuesto de:
 Jeu complet en valise plastique, se composant de:
 Serie completa in valigetta di plastica, composta da:

40.60.61 Verbandsäge mit Netzteil
 Plaster saw with power supply
 Sierra para vendajes con equipo de alimentación
 Scie à plâtre avec transformateur
 Sega per gesso con sezione rete

40.62.50 1 Sägeblatt Ø 50 mm
 1 Saw blade Ø 50 mm
 1 Hoja de sierra Ø 50 mm
 1 Lame de scie Ø 50 mm
 1 Lama da sega Ø 50 mm

40.60.65 1 Sägeblatt Ø 65 mm
 1 Saw blade Ø 65 mm
 1 Hoja de sierra Ø 65 mm
 1 Lame de scie Ø 65 mm
 1 Lama da sega Ø 65 mm

40.60.64 1 Tiefenanschlag
 1 Depth gauge
 1 Tope de profundidad
 1 Guide de profondeur réglable
 1 Guida di profondità

Netzteil
 Power Supply
 Equipo de alimentación
 Transformateur
 Sezione rete



Technische Daten:
Technical data:
Especificaciones técnicas:
Caracteristiques techniques:
Dati tecnici:

110 / 240 Volt
 50 / 60 Hz
 100 Watt
 210 mm x Ø 46 mm, 760 g

OSCILLOCOMPACT



Ø 50 mm Ø 65 mm

40.62.50 40.62.65

Sägeblätter für Kunststoffverband
 Saw blades for synthetic dressing
 Hojas de sierra para vendajes sintéticos
 Lames de scie pour bandage synthétique
 Lame da sega per bendaggi di plastica



Ø 50 mm

40.61.50



Ø 50 mm Ø 65 mm

40.60.50 40.60.65

Sägeblätter für Naturgipsverband
 Saw blades for plaster dressing
 Hojas de sierra para vendajes de yeso natural
 Lames de scie pour bandage en plâtre naturel
 Lame da sega per bendaggi in gesso naturale



Ø 65 mm

40.61.65



40.60.64

Tiefenanschlag
 Depth gauge
 Tope de profundidad
 Guide de profondeur réglable
 Guida di profondità



40.60.62

Kunststoffkoffer
 Plastic case
 Maletín de plástico
 Valise plastique
 Valigetta di plastica



Staubsauger
Vacuum Cleaner
Aspirador
Aspirateur
Aspiratore

OSCI-CLEAN II

220-240 V, 1200 W

40.60.82**40.60.84**

Ersatz-Papiersack
 Spare paper bag
 Saco de papel de repuesto
 Sac papier de rechange
 Sacchetto di carta di ricambio

Verpackungseinheit 10 Stück
 Packing unit 10 pieces
 Unidad de 10 piezas
 Emballage de 10 pièces
 Confezione da 10 pezzi

für; for; para; pour; per:

OSCILLOCOMPACT

Technische Daten:
Technical data:
Especificaciones técnicas:
Caracteristiques techniques:
Dati tecnici:

0,3 micron	Filtrierung Filtration Filtración Filtration Filtrazione
20 l	Tankinhalt Tank capacity Capacidad del tanque Capacité de la cuve Capacità del cassone
89 cm	Höhe Height Altura Hauteur Altezza
13 kg	Gewicht Weight Peso Poids Peso

Lieferumfang:

1 Staubsauger (ohne Gipsäge) inkl. Saugschlauch und Ständer für Saugschlauch sowie Ablageschale für Gipsäge, 1 Saugdüse für die Befestigung des Saugschlauchs an der Gipsäge, 2 HEPA Filter, 1 Polyester-Filter, 1 Papiersack

Content of delivery:

1 Vacuum cleaner (without plaster saw) incl. suction tube, support device for suction tube and support plate for plaster saw, 1 suction nozzle to connect the suction tube to the plaster saw, 2 HEPA filters, 1 polyester filter, 1 paper bag

Suministro:

1 Aspirador (sin sierra de yeso) incl. manguera de aspiración y soporte para la manguera, además una bandeja para depositar la sierra de yeso, 1 tobera aspiradora para la fijación de la manguera de aspiración a la sierra de yeso, 2 filtros HEPA, 1 filtro de poliéster, 1 saco de papel

Contenu de base:

1 Aspirateur (sans scie à plâtre) avec tuyau d'aspiration et support pour le tuyau d'aspiration et panier pour le rangement de la scie à plâtre, 1 buse d'aspiration pour la fixation du tuyau d'aspiration à la scie à plâtre, 2 filtres HEPA, 1 filtre polyester, 1 sac papier.

Fornitura composta da:

1 Aspiratore (senza sega per gesso) incl. tubo di aspirazione e supporto per il tubo come anche l'appoggio per sega per gesso, 1 ugello per l'applicazione del tubo d'aspirazione alla sega, 2 filtri HEPA, 1 filtro di poliestere, 1 sacchetto di carta

**Handbohrapparat
Hand Drill
Perforador de mano
Perforateur à main
Trapano a mano**



76.50.70

Moore

76.50.71

Handbohrapparat allein
Brace only
Perforador de mano sólo
Perforateur à main seul
Trapano a mano solo

Ø 3,2 mm



7 cm – 2¾" 9 cm – 3½"

76.50.77 76.50.79

Spiralbohrer
Twist drills
Brocas espirales
Forets hélicoïdaux
Perforatori elicoidali

- ▶ mit Dreibackenspannfutter, von Hand zu spannen, komplett mit 2 Spiralbohrern Nr. 76.50.77 und 1 Spiralbohrer Nr. 76.50.79
- ▶ with three-jaw chuck, locked by hand, complete with 2 twist drills No. 76.50.77 and 1 twist drill No. 76.50.79
- ▶ con manguito trimandibular, tensor de mano, completo con 2 brocas espirales No. 76.50.77 y 1 broca espiral No. 76.50.79
- ▶ avec mandrin à trois mâchoires, tendre à main, complet avec 2 forets hélicoïdaux No. 76.50.77 et 1 foret hélicoïdal No. 76.50.79
- ▶ con mandrino a tre ganasce, da tendere a mano, completo di 2 perforatori elicoidali No. 76.50.77 ed 1 perforatore elicoidali No. 76.50.79

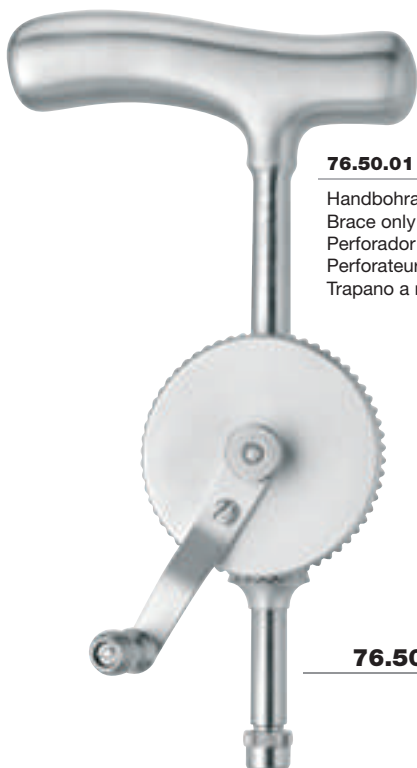

Handbohrapparate
Hand Drills
Perforadoras de mano
Perforateurs à main
Trapani a mano

**76.50.01**

Handbohrapparat allein
 Brace only
 Perforador de mano sólo
 Perforateur à main seul
 Trapano a mano solo

76.50.00**Stille**

- ▶ komplett mit 9 Bohrern und Fräsern
Nr. 76.50.11 – 76.50.19
- ▶ complete with 9 drills and burrs
No. 76.50.11 – 76.50.19
- ▶ completo con 9 brocas y fresas
No. 76.50.11 – 76.50.19
- ▶ complet avec 9 forets et fraises
No. 76.50.11 – 76.50.19
- ▶ completo con 9 perforatori e frese
No. 76.50.11 – 76.50.19

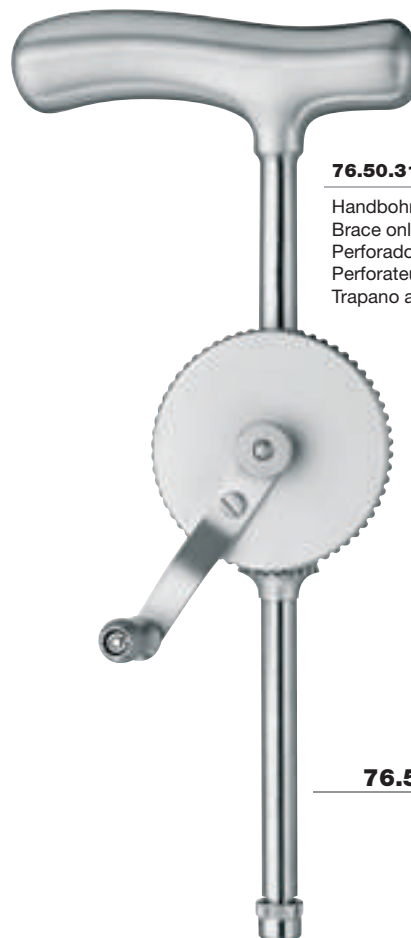
**76.50.31**

Handbohrapparat allein
 Brace only
 Perforador de mano solo
 Perforateur à main seul
 Trapano a mano solo

76.50.30**Stille-Sherman**

- ▶ komplett mit 3 Bohrern
Nr. 76.50.11, 76.50.12 und 76.50.13
- ▶ complete with 3 drills
No. 76.50.11, 76.50.12 and 76.50.13
- ▶ completo con 3 brocas
No. 76.50.11, 76.50.12 y 76.50.13
- ▶ complet avec 3 forets
No. 76.50.11, 76.50.12 et 76.50.13
- ▶ completo con 3 perforatori
No. 76.50.11, 76.50.12 e 76.50.13

Passende Bohrer, Fräser und Trepine siehe Folgesseite.
 See following page for suitable drills, burrs and trephines.
 Brocas, fresas y trépanos adecuados vease la siguiente página.
 Forets, fraises et tréphine appropriés voir à la page suivante.
 Perforatori adatti, frese e trapani vedi pagina seguente.



Einsätze für Handbohrapparate
Hand Drills Accessories
Insertos para perforadoras de mano
Embouts pour perforateurs à main
Inserti per trapani a mano

Spiralbohrer
 Twist drills
 Brocas espirales
 Forets hélicoïdaux
 Perforatori elicoidali



1 – Ø 2,5 mm # 2 – Ø 3 mm # 3 – Ø 3,5 mm # 4 – Ø 4 mm # 5 – Ø 10 mm

76.50.11 76.50.12 76.50.13 76.50.14 76.50.15

Trephine
 Trephine
 Trépano
 Tréphine
 Trapano

Fräser
 Burrs
 Fresas
 Fraises
 Frese



6 – Ø 5 mm # 7 – Ø 8 mm # 8 – Ø 12 mm # 9 – Ø 16 mm # 1 – 9

76.50.16 76.50.17 76.50.18 76.50.19 76.50.10

Satz komplett
 Set complete
 Juego completo
 Jeu complet
 Set completo

passend für 76.50.00 und 76.50.30
 suitable for 76.50.00 and 76.50.30
 adecuados para 76.50.00 y 76.50.30
 appropriés pour 76.50.00 et 76.50.30
 adatti per 76.50.00 e 76.50.30



Handbohrapparat
Hand Drill
Perforador de mano
Perforateur à main
Trapano a mano

für Bohrer bis Ø 4 mm,
für KIRSCHNER Bohrdrähte bis Ø 3 mm
for twist drills up to Ø 4 mm,
for KIRSCHNER wires up to Ø 3 mm
para brocas hasta Ø 4 mm,
para brocas de KIRSCHNER hasta Ø 3 mm
pour forets jusqu'à Ø 4 mm,
pour broches de KIRSCHNER jusqu'à Ø 3 mm
per perforatori fino Ø 4 mm,
per perforatori filiformi di KIRSCHNER fino Ø 3 mm

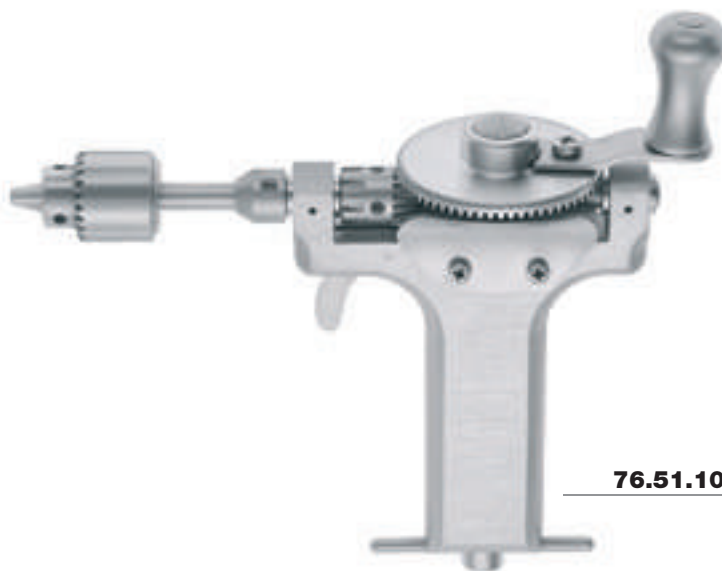

76.51.10

Bunnell



76.51.11

Spannschlüssel allein
Tightening wrench only
Llave tensora sola
Clé seule
Chiave di serraggio

- ▶ mit Jacobs-Dreibackenspannfutter und Schlüssel, kleines Modell, mit längsdurchbohrtem Kanal für KIRSCHNER Bohrdrähte
- ▶ with Jacobs three-jaw chuck and wrench, small pattern, with axial channel for passing KIRSCHNER wires
- ▶ con plato de tres mordazas de Jacobs, con llave, modelo pequeño, con conducto longitudinal para pasar brocas filiformes de KIRSCHNER
- ▶ avec mandrin de Jacobs à trois mâchoires, avec clé, petit modèle, avec conduit longitudinal pour broches de KIRSCHNER
- ▶ con mandrino Jacobs a tre ganasce, con chiave, modello piccolo, con condotto cannulato per il passaggio di perforatori filiformi di KIRSCHNER

**Handbohrapparat
Hand Drill
Perforador de mano
Perforateur à main
Trapano a mano**

für Bohrer bis Ø 6 mm,
für KIRSCHNER Bohrdrähte bis Ø 3 mm

for twist drills up to Ø 6 mm,
for KIRSCHNER wires up to Ø 3 mm

para brocas hasta Ø 6 mm,
para brocas de KIRSCHNER hasta Ø 3 mm

pour forets jusqu'à Ø 6 mm,
pour broches de KIRSCHNER jusqu'à Ø 3 mm

per perforatori fino Ø 6 mm,
per perforatori filiformi di KIRSCHNER fino Ø 3 mm



Griff umstellbar
Adjustable handle
Mango ajustable
Manche ajustable
Manico reversibile

76.50.80

- ▶ mit umstellbarem Handgriff und Dreibackenspannfutter, mit Schlüssel, mit längsdurchbohrtem Kanal für KIRSCHNER Bohrdrähte
- ▶ with adjustable handle and three-jaw chuck with wrench, with axial channel for passing KIRSCHNER wires
- ▶ con mango ajustable y plato de tres mordazas, con llave, con conducto longitudinal para pasar brocas filiformes de KIRSCHNER
- ▶ avec manche ajustable et mandrin à trois mâchoires, avec clé, avec conduit longitudinal pour broches de KIRSCHNER
- ▶ con manico reversibile e mandrino a tre ganasce, con chiave, con condotto cannulato per il passaggio di perforatori filiformi di KIRSCHNER



76.50.81

Spannschlüssel allein
Tightening wrench only
Llave tensora sola
Clé seule
Chiave di serraggio sola



Handbohrapparat, Bohrer
Hand Drill, Drills
Perforador de mano, Brocas
Perforateur à main, Forets
Trapano a mano, Perforatori

für Bohrer bis Ø 7 mm,
 für KIRSCHNER Bohrdrähte bis Ø 4 mm

for twist drills up to Ø 7 mm,
 for KIRSCHNER wires up to Ø 4 mm

para brocas hasta Ø 7 mm,
 para brocas de KIRSCHNER hasta Ø 4 mm

pour forets jusqu'à Ø 7 mm,
 pour broches de KIRSCHNER jusqu'à Ø 4 mm

per perforatori fino Ø 7 mm,
 per perforatori filiformi di KIRSCHNER fino Ø 4 mm

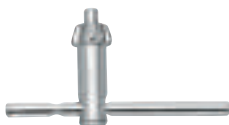
**76.51.20****Ralk****76.51.21**

Spannschlüssel allein
 Tightening wrench only
 Llave tensora sola
 Clé seule
 Chiave di serraggio sola

- ▶ mit Dreibackenspannfutter und Schlüssel,
mit längsdurchbohrtem Kanal für KIRSCHNER Bohrdrähte
- ▶ with three-jaw chuck and wrench,
with axial channel for passing KIRSCHNER wires
- ▶ con plato de tres mordazas, con llave,
con conducto longitudinal para pasar brocas filiformes de KIRSCHNER
- ▶ avec mandrin à trois mâchoires, avec clé,
avec conduit longitudinal pour broches de KIRSCHNER
- ▶ con mandrino a tre ganasce, con chiave,
con condotto cannulato per il passaggio di perforatori filiformi di KIRSCHNER

Spiralbohrer
 Twist drills
 Brocas espirales
 Forets hélicoïdaux
 Perforatori elicoidali



76.69.15	Ø 1,5 mm	7,0 cm – 2¾"
76.69.20	Ø 2,0 mm	8,5 cm – 3⅜"
76.69.25	Ø 2,5 mm	9,5 cm – 3¾"
76.69.30	Ø 3,0 mm	10,0 cm – 4"
76.69.32	Ø 3,2 mm	10,0 cm – 4"
76.69.35	Ø 3,5 mm	11,0 cm – 4⅜"
76.69.40	Ø 4,0 mm	12,0 cm – 4¾"
76.69.45	Ø 4,5 mm	13,0 cm – 5⅛"
76.69.50	Ø 5,0 mm	13,0 cm – 5⅛"
76.69.60	Ø 6,0 mm	14,0 cm – 5½"

**Handbohrapparat
Hand Drill
Perforador de mano
Perforateur à main
Trapano a mano**

für Bohrer bis Ø 6,5 mm,
für KIRSCHNER Bohrdrähte bis Ø 4 mm

for twist drills up to Ø 6,5 mm,
for KIRSCHNER wires up to Ø 4 mm

para brocas hasta Ø 6,5 mm,
para brocas de KIRSCHNER hasta Ø 4 mm

pour forets jusqu'à Ø 6,5 mm,
pour broches de KIRSCHNER jusqu'à Ø 4 mm

per perforatori fino Ø 6,5 mm,
per perforatori filiformi di KIRSCHNER fino Ø 4 mm



76.51.60

Smedberg

- ▶ mit Jacobs-Dreibackenspannfutter und Schlüssel,
mit längsdurchbohrtem Kanal für KIRSCHNER Bohrdrähte
- ▶ with Jacobs three-jaw chuck and wrench,
with axial channel for passing KIRSCHNER wires
- ▶ con plato de tres mordazas de Jacobs, con llave,
con conducto longitudinal para pasar brocas filiformes de KIRSCHNER
- ▶ avec mandrin de Jacobs à trois mâchoires, avec clé,
avec conduit longitudinal pour broches de KIRSCHNER
- ▶ con mandrino Jacobs a tre ganasce, con chiave,
con condotto cannolato per il passaggio di perforatori filiformi di KIRSCHNER



76.51.61

Spannschlüssel allein
Tightening wrench only
Llave tensora sola
Clé seule
Chiave di serraggio sola

MEDICONTAINER CONTAINER System



ORTHO PAEDICS

IMPLANTS AND INSTRUMENTS

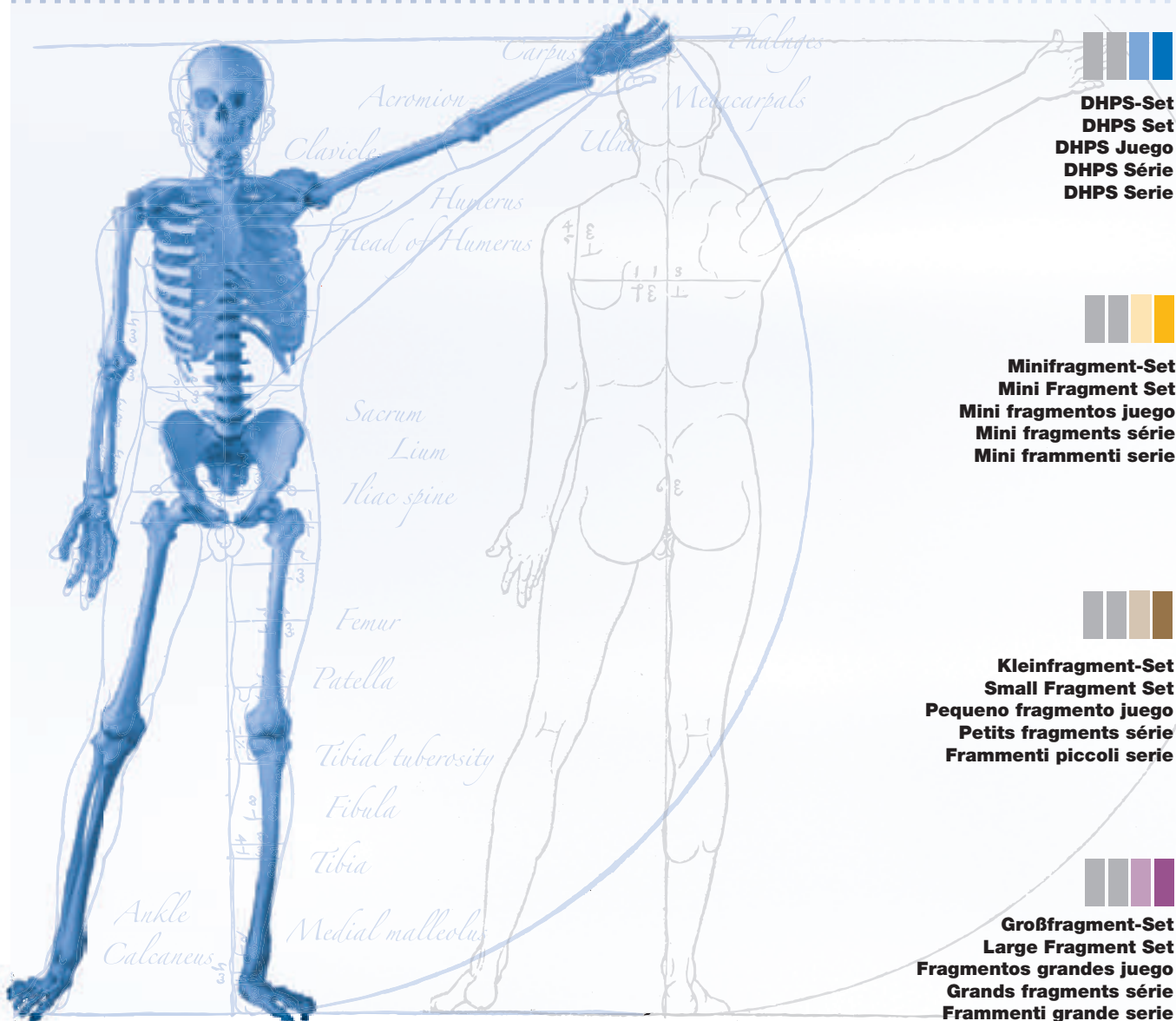

DHPS-Set
DHPS Set
DHPS Juego
DHPS Série
DHPS Serie

Minifragment-Set
Mini Fragment Set
Mini fragmentos juego
Mini fragments série
Mini frammenti serie

Kleinfragment-Set
Small Fragment Set
Pequeno fragmento juego
Petits fragments série
Frammenti piccoli serie

Großfragment-Set
Large Fragment Set
Fragmentos grandes juego
Grands fragments série
Frammenti grande serie





DHPS-Set
DHPS Set
DHPS Juego
DHPS Série
DHPS Serie

DHPS Set complete**708.30.50** contains ▾

Instruments	Qty
708.01.02 Targeting device · 135°	1
708.01.05 Targeting device · 150°	1
708.01.07 Guide wire · 2,5 mm · 230 mm	10
708.01.08 Direct measuring device	1
708.01.09 Three step reamer for standard DHPS plates	1
708.01.11 Tap · 12,5 mm · 220 mm	1
708.01.12 T-handle · large	1
708.01.13 Wrench with T-handle	1
708.01.14 Coupling screw · short	1
708.01.15 Guide shaft	1
708.01.16 Coupling screw · long	1
708.01.17 Centering sleeve · short	1
708.01.18 Centering sleeve · long	1
708.01.19 Impactor	1
709.30.12 Screwdriver insert · hexagonal · 2.5 mm · 100 mm	1
709.30.23 Drill · Ø 2,0 mm · 100 mm	2
709.30.40 Screw holding forceps	1
711.30.06 Depth gauge · large	1
711.30.09 Double drill sleeve · 6,5 / 3,2 mm	1
711.30.10 Universal drill guide · 4,5 / 3,2mm	1
711.30.12 T-Handle · small · with quick coupling	1
711.30.15 Screwdriver · hexagonal · 3,5 mm · 245 mm	1
711.30.17 Holding sleeve for 4,5 mm screws	1
711.30.18 Drill · Ø 3,2 mm · 145 mm	2
711.30.20 Drill · Ø 4,5 mm · 145 mm	2
711.30.29 Tap · 4,5 mm · 125 mm	2
711.30.30 Tap calibrated · 6,5 mm · 200 mm	1

DHPS Implant Set	Qty
76.10.70 Kirschner wire · Ø 2,0 mm · 15cm · P/10	1
708.00.00 DHPS Compression screw · 36 mm	3
708.00.04 DHPS Traction screw · 65 mm	1
708.00.05 DHPS Traction screw · 70 mm	1
708.00.06 DHPS Traction screw · 75 mm	1
708.00.07 DHPS Traction screw · 80 mm	1
708.00.08 DHPS Traction screw · 85 mm	2
708.00.09 DHPS Traction screw · 90 mm	2
708.00.10 DHPS Traction screw · 95 mm	2
708.00.11 DHPS Traction screw · 100 mm	2
708.00.12 DHPS Traction screw · 105 mm	1
708.00.13 DHPS Traction screw · 110 mm	1
708.00.14 DHPS Traction screw · 115 mm	1
708.35.04 DHPS Hip screw plate · 135° · 4 holes · 78 mm	3
708.35.05 DHPS Hip screw plate · 135° · 5 holes · 94 mm	2
708.35.06 DHPS Hip screw plate · 135° · 6 holes · 110 mm	2
708.50.04 DHPS Hip screw plate · 150° · 4 holes · 78 mm	1
708.50.05 DHPS Hip screw plate · 150° · 5 holes · 94 mm	1
708.50.06 DHPS Hip screw plate · 150° · 6 holes · 110 mm	1

	Qty
49.60.15 Medicontainer · 590 x 290 x 150 mm · silver	1
49.97.24 Wire basket · 540 x 252 x 60 mm	1
708.30.55 DHPS implant wire basket only	1

Minifragment-Set
Mini Fragment Set
Mini fragmentos juego
Mini fragments série
Mini frammenti serie

Mini Fragment Set complete

709.30.50 contains ▾



Instruments	Qty
14.30.17 HM wire cutter · 17,5cm	1
14.46.14 Flat nose pliers · 14cm	1
26.64.13 Raspatory · 3mm · 18,5 cm	1
75.23.50 Screwdriver handle with dental coupling	1
78.35.11 Bone lever · 6 mm · 16 cm	1
78.35.12 Bone lever · 8 mm · 16 cm	1
78.35.13 Bone lever · 15 mm · 16 cm	1
351.64.01 Cleaning hook	1
709.30.00 Bending lever for mini plates	1
709.30.03 Bending pliers for mini plates	1
709.30.04 Depth gauge mini	1
709.30.11 Screwdriver insert · 1,5 mm	1
709.30.12 Screwdriver insert · hexagonal · 2,5 mm · 100 mm	1
709.30.15 Screwdriver hexagonal · 2,5 mm · 210 mm	1
709.30.17 Holding sleeve for 1,5 mm screws	1
709.30.19 Holding sleeve for 2,7 / 3,5 mm screws	1
709.30.20 Drill · Ø 1,1 mm · 60 mm	2
709.30.21 Drill · Ø 1,5 mm · 85 mm	2
709.30.23 Drill · Ø 2,0 mm · 100 mm	2
709.30.25 Drill · Ø 2,7 mm · 100 mm	2
709.30.30 Countersink for screws 1,5 / 2,0 mm · 57 mm	1
709.30.31 Countersink for screws 2,7 / 3,5 / 4,0 mm · 72 mm	1
709.30.35 Holding forceps for small plates	1
709.30.38 Reposition forceps · broad	1
709.30.40 Screw holding forceps	1
709.30.41 Bending bolt for Kirschner wires 0,8 - 1,25 mm	1
710.30.07 Depth gauge small	1

Cortical screws 1,5 mm



709.15.01	6 mm	1
709.15.02	7 mm	1
709.15.03	8 mm	1
709.15.04	9 mm	1
709.15.05	10 mm	1
709.15.06	11 mm	1
709.15.07	12 mm	1
709.15.08	14 mm	1
709.15.09	16 mm	1

Cortical screws 2,0 mm



709.20.01	6 mm	1
709.20.02	8 mm	1
709.20.03	10 mm	1
709.20.04	12 mm	1
709.20.05	14 mm	1
709.20.06	16 mm	1
709.20.07	18 mm	1
709.20.08	20 mm	1



Verpackungseinheit "X" Stück
 Packing unit "X" pieces
 Paquete de "X" unidades
 Emballage de "X" pièces
 Confezione da "X" pezzi



Minifragment-Set
Mini Fragment Set
Mini fragmentos juego
Mini fragments série
Mini frammenti serie

Cortical screws 2,7 mm		
709.27.01	6 mm	1
709.27.02	8 mm	1
709.27.03	10 mm	1
709.27.04	12 mm	1
709.27.05	14 mm	1
709.27.06	16 mm	1
709.27.07	18 mm	1
709.27.08	20 mm	1
709.27.09	22 mm	1
709.27.10	24 mm	1

Washer Ø 4,5 mm		
709.00.00	2,1/4,5 mm	1

Plates for cortical screws 1,5 mm

T-plates with 9 holes 1,5 mm		Qty
709.01.02	head 3	2
709.01.03	head 4	2

Condylar plate left 1,5 mm		Qty
709.03.05	6	2

Straight plate 1,5 mm		Qty
709.00.20	20	2

Condylar plate right 1,5 mm		Qty
709.03.06	6	2

Plates for cortical screws 2,0 mm

Compression plates 2,0 mm		Qty
709.04.03	3	2
709.04.04	4	2
709.04.05	5	2

Compression plate 2,0 mm		Qty
709.04.20	20	2

Condylar plate left 2,0 mm		Qty
709.08.00	6	2

Condylar plate right 2,0 mm		Qty
709.08.01	6	2

T-plates with 9 holes 2,0 mm		Qty
709.05.00	head 3	2
709.05.01	head 4	2



Verpackungseinheit "X" Stück
 Packing unit "X" pieces
 Paquete de "X" unidades
 Emballage de "X" pièces
 Confezione da "X" pezzi



Anzahl der Löcher
 Number of holes
 Número de los orificios
 Nombre de trous
 Numero di fori



Minifragment-Set
Mini Fragment Set
Mini fragmentos juego
Mini fragments série
Mini frammenti serie

Plates for cortical screws 2,7 mm

Quarter tubular plates 2,7 mm	(x)	Qty
709.10.03	3	2
709.10.04	4	2
709.10.05	5	2
709.10.06	6	1
709.10.07	7	1
709.10.08	8	1

L-Plate oblique, left 2,7 mm	(x)	Qty
709.13.00	3	2

L-Plate oblique, right 2,7 mm	(x)	Qty
709.13.01	3	2

T-Plate 2,7 mm	(x)	Qty
709.11.03	3	4

Kirschner wires

Kirschner wires with trocar point 6 cm		P ₁₀
76.06.58	0,8 mm	1

Kirschner wires with trocar point 15 cm		P ₁₀
76.10.60	1,0 mm	1
76.10.62	1,2 mm	1
76.10.66	1,6 mm	1

49.50.13	Medicontainer · 290 x 290 x 135 mm · silver	1
49.97.02	Wire basket · 240 x 255 x 50 mm	2
709.30.55	Mini Fragment implant tray only	1

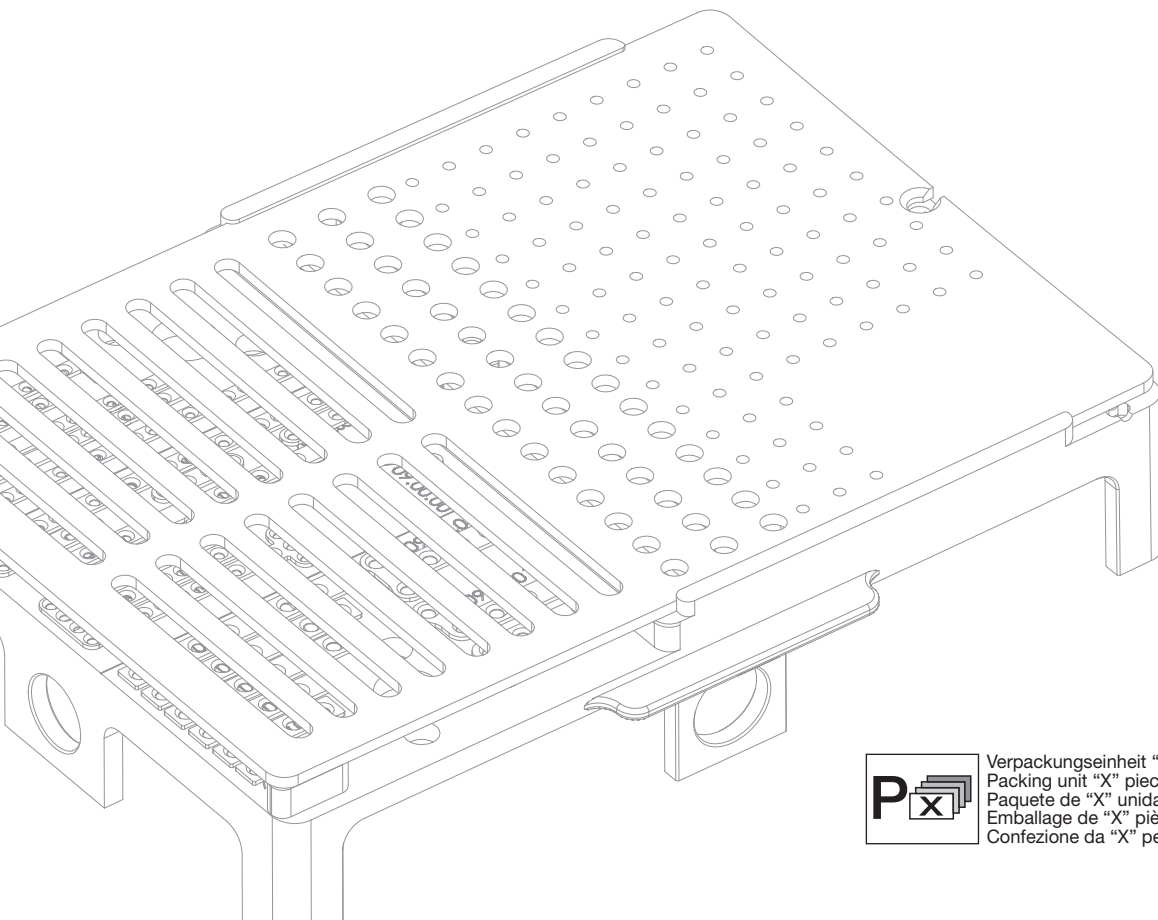

P_x Verpackungseinheit "X" Stück
 Packing unit "X" pieces
 Paquete de "X" unidades
 Emballage de "X" pièces
 Confezione da "X" pezzi



Kleinfragment-Set
Small Fragment Set
Pequeno fragmento juego
Petits fragments série
Frammenti piccoli serie

Small Fragment Set complete**710.30.50** contains ▼

49.50.15

710.30.55

49.97.02

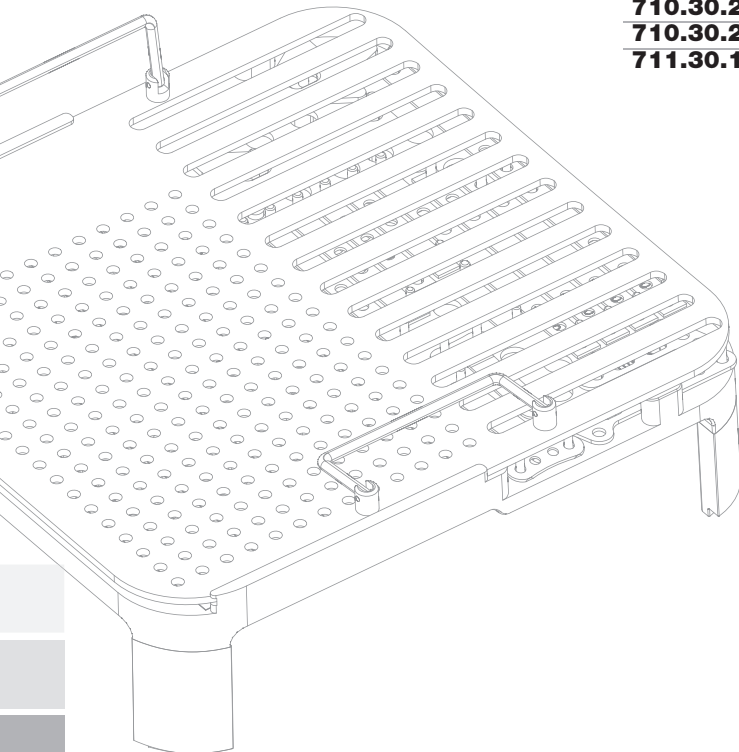

Instruments	Qty
14.30.17 HM Wire cutter 17,5 cm	1
26.64.26 Raspatory 6 mm · 18,5 cm	1
35.11.13 Bone clamp 13,5 cm	1
35.14.14 Bone clamp 14 cm	1
35.76.19 Verbrugge bone clamp 19 cm · self-centering	1
76.45.19 Flat nose pliers · 19 cm	1
78.35.11 Bone lever 6 mm · 16 cm	2
78.35.12 Bone lever 8 mm · 16 cm	2
351.64.01 Cleaning hook	1
709.30.01 Bending lever · right · for plates 3,5 mm	1
709.30.02 Bending lever · left · for plates 3,5 mm	1
709.30.05 Parallel drill guide/sleeve 2,0 mm	1
709.30.12 Screwdriver insert 2,5 mm · 100 mm · hexagonal	1
709.30.15 Screwdriver 2,5 mm · 210 mm · hexagonal	1
709.30.31 Countersink for screws 2,7 / 3,5 / 4,0 mm · 72 mm	1
709.30.40 Screw holding forceps	1
710.30.00 Bending bolt for Kirschner wires	1
710.30.01 Bending template 3,5 mm · 5 holes	1
710.30.02 Bending template 3,5 mm · 7 holes	1
710.30.03 Bending template 3,5 mm · 9 holes	1
710.30.07 Depth gauge · small	1
710.30.08 Insert drill sleeve 3,5 / 2,5 mm	1
710.30.09 Drill guide 3,5 / 2,5 mm · neutral and excentric	1
710.30.11 Drill guide 3,5 mm · neutral and excentric	1
710.30.12 Holding sleeve for 3,5 / 4,0 mm screws	1
710.30.13 Drill Ø 2,5 mm · 110 mm · for quick coupling	2
710.30.15 Drill Ø 3,5 mm · 110 mm · for quick coupling	2
710.30.21 Tap Ø 3,5 mm · 110 mm · for cortical screws	2
710.30.23 Tap Ø 4,0 mm · 110 mm · for spongiosa screws	2
711.30.12 T-Handle · small · with quick coupling	1

Cortical screws 3,5 mm

710.35.01	10 mm	2
710.35.02	12 mm	2
710.35.03	14 mm	2
710.35.04	16 mm	2
710.35.05	18 mm	2
710.35.06	20 mm	2
710.35.07	22 mm	2
710.35.08	24 mm	2
710.35.09	26 mm	2
710.35.10	28 mm	2
710.35.11	30 mm	2
710.35.12	32 mm	2
710.35.14	36 mm	2
710.35.16	40 mm	2
710.35.17	45 mm	1
710.35.18	50 mm	1



Verpackungseinheit "X" Stück
 Packing unit "X" pieces
 Paquete de "X" unidades
 Emballage de "X" pièces
 Confezione da "X" pezzi



Kleinfragment-Set
Small Fragment Set
Pequeno fragmento juego
Petits fragments série
Frammenti piccoli serie

Spongiosa screws 4,0 mm		P ₅
710.40.01	10 mm	1
710.40.02	12 mm	1
710.40.03	14 mm	1
710.40.04	16 mm	1
710.40.05	18 mm	1
710.40.06	20 mm	1
710.40.07	22 mm	1
710.40.08	24 mm	1
710.40.09	26 mm	1
710.40.10	28 mm	1
710.40.11	30 mm	1
710.40.14	36 mm	1
710.40.16	40 mm	1
710.40.19	46 mm	1
710.40.21	50 mm	1
710.40.22	55 mm	1
710.40.23	60 mm	1

Washer		P ₅
710.00.00	4,0/7,0 mm	2

Plates for cortical screws 3,5 mm and spongiosa screws 4,0 mm

One third plates with collar 3,5 mm	(x)	Qty
710.01.03	3	1
710.01.04	4	2
710.01.05	5	2
710.01.06	6	2
710.01.07	7	1
710.01.08	8	1

Plates for cortical screws 3,5 mm and spongiosa screws 4,0 mm

Compression plates 3,5 mm	(x)	Qty
710.00.06	6	1
710.00.07	7	2
710.00.08	8	2
710.00.09	9	1
710.00.10	10	1

T-Plates 90° 3,5 mm	(x)	Qty
710.02.03	3/3	1
710.02.04	4/4	1

T-Plates oblique 3,5 mm	(x)	Qty
710.03.03	3/3	1
710.03.05	5/3	1

Cloverleaf plates 3,5 mm	(x)	Qty
710.04.03	3	1
710.04.04	4	1

Kirschner wires

Kirschner wires with trocar point 15 cm	Ø mm	P ₁₀
76.10.62	1,2	1
76.10.66	1,6	1
76.10.70	2	1

49.50.15	Medicontainer · 290 x 290 x 150 mm · silver	1
49.97.02	Wire basket · 240 x 255 x 50 mm	1
710.30.55	Small Fragment implant tray only	1

(x) Anzahl der Löcher
 Number of holes
 Número de los orificios
 Nombre de trous
 Numero di fori

P_x Verpackungseinheit "X" Stück
 Packing unit "X" pieces
 Paquete de "X" unidades
 Emballage de "X" pièces
 Confezione da "X" pezzi



Großfragment-Set
Large Fragment Set
Fragmentos grandes juego
Grands fragments série
Frammenti grande serie



49.60.13

711.30.60

49.97.21

Large Fragment Set complete**711.30.50** contains ▼

Instruments		Qty
351.64.01	Cleaning hook	1
709.30.40	Screw holding forceps	1
710.30.25	Plate tensioner · with gauge	1
710.30.26	Combination wrench 11mm	1
711.30.01	Bending template 4,5 mm · 5 holes	1
711.30.02	Bending template 4,5 mm · 7 holes	1
711.30.03	Bending template 4,5 mm · 9 holes	1
711.30.04	Bending template 4,5 mm · 12 holes	1
711.30.06	Depth gauge · large	1
711.30.08	Double drill sleeve 4,5 / 3,2 mm	1
711.30.09	Double drill sleeve 6,5 / 3,2 mm	1
711.30.10	Universal drill guide 4,5 / 3,2 mm	1
711.30.11	Drill guide 4,5 mm · neutral and excentric	1
711.30.12	T-Handle small · with quick coupling	1
711.30.13	Screwdriver 3,5 mm · 100 mm · hexagonal	1
711.30.15	Screwdriver 3,5 mm · 245 mm · hexagonal	1
711.30.17	Holding sleeve for 4,5 mm screws	1
711.30.18	Drill Ø 3,2mm · 145 mm	3
711.30.20	Drill Ø 4,5mm · 145 mm	2
711.30.28	Countersink for screws 4,5 / 6,5 mm · 180 mm	1
711.30.29	Tap 4,5 mm · 125 mm	2
711.30.30	Tap 6,5 mm · 200 mm · calibrated	1

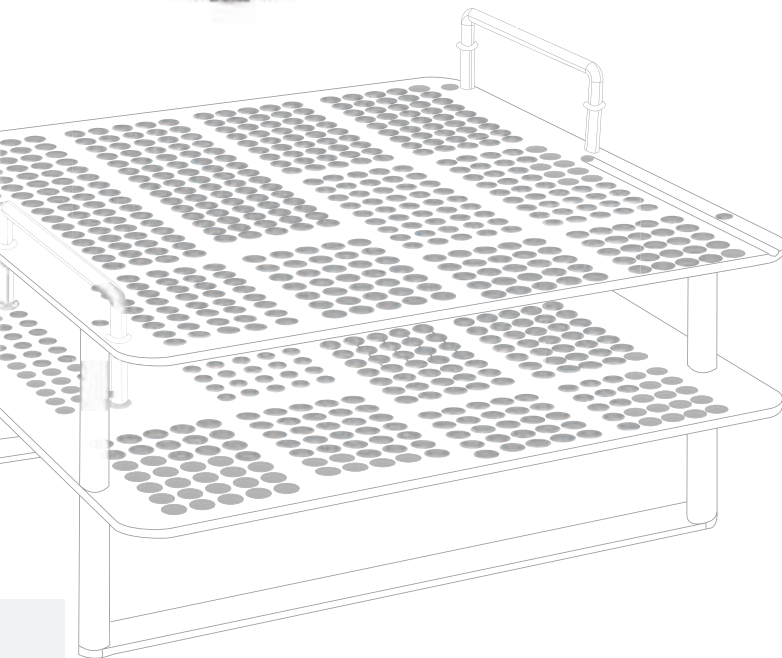
**Cortical screws 4,5 mm**

711.45.01	14 mm	1
711.45.02	16 mm	1
711.45.03	18 mm	1
711.45.04	20 mm	1
711.45.05	22 mm	1
711.45.06	24 mm	1
711.45.07	26 mm	2
711.45.08	28 mm	2
711.45.09	30 mm	2
711.45.10	32 mm	2
711.45.11	34 mm	2
711.45.12	36 mm	2
711.45.13	38 mm	2
711.45.14	40 mm	2
711.45.15	42 mm	1
711.45.16	44 mm	1
711.45.17	46 mm	1
711.45.18	48 mm	1
711.45.19	52 mm	1
711.45.22	56 mm	1
711.45.24	60 mm	1
711.45.26	64 mm	1
711.45.28	68 mm	1



Verpackungseinheit "X" Stück
 Packing unit "X" pieces
 Paquete de "X" unidades
 Emballage de "X" pièces
 Confezione da "X" pezzi



Großfragment-Set
Large Fragment Set
Fragmentos grandes juego
Grands fragments
Frammenti grande

Spongiosa screws, 6,5mm full thread		P ₅
711.65.01	25 mm	1
711.65.02	30 mm	1
711.65.03	35 mm	1
711.65.04	40 mm	1
711.65.05	45 mm	1
711.65.06	50 mm	1
711.65.07	55 mm	1
711.65.08	60 mm	1
711.65.09	65 mm	1
711.65.10	70 mm	1
711.65.11	75 mm	1
711.65.12	80 mm	1
711.65.13	85 mm	1
711.65.14	90 mm	1
711.65.15	95 mm	1
711.65.16	100 mm	1
711.65.17	105 mm	1
711.65.18	110 mm	1

Spongiosa screws, 6,5 mm partial thread 32 mm		P ₅
711.67.01	45 mm	1
711.67.02	50 mm	1
711.67.03	55 mm	1
711.67.04	60 mm	1
711.67.05	65 mm	1
711.67.06	70 mm	1
711.67.07	75 mm	1
711.67.08	80 mm	1
711.67.09	85 mm	1
711.67.10	90 mm	1
711.67.11	95 mm	1
711.67.12	100 mm	1
711.67.13	105 mm	1
711.67.14	110 mm	1

Malleolar screws 4,5 mm		P ₅
711.47.02	25 mm	1
711.47.03	30 mm	1
711.47.04	35 mm	1
711.47.05	40 mm	1
711.47.06	45 mm	1
711.47.07	50 mm	1
711.47.08	55 mm	1
711.47.09	60 mm	1
711.47.10	65 mm	1
711.47.11	70 mm	1

Spongiosa screws, 6,5 mm partial thread 16 mm		P ₅
711.66.01	30 mm	1
711.66.02	35 mm	1
711.66.03	40 mm	1
711.66.04	45 mm	1
711.66.05	50 mm	1
711.66.06	55 mm	1
711.66.07	60 mm	1
711.66.08	65 mm	1
711.66.09	70 mm	1
711.66.10	75 mm	1
711.66.11	80 mm	1
711.66.12	85 mm	1
711.66.13	90 mm	1
711.66.14	95 mm	1
711.66.15	100 mm	1
711.66.16	105 mm	1
711.66.17	110 mm	1

Washer		P ₅
711.00.01	6,8 / 13 mm	1



49.50.15

711.30.55

P_x Verpackungseinheit "X" Stück
 Packing unit "X" pieces
 Paquete de "X" unidades
 Emballage de "X" pièces
 Confezione da "X" pezzi



Großfragment-Set
Large Fragment Set
Fragmentos grandes juego
Grands fragments série
Frammenti grande serie

Plates for cortical screws 4,5 mm and spongiosa screws 6,5 mm

Compression plates 4,5 mm narrow	(x)	Qty
711.00.06	6	2
711.00.07	7	2
711.00.08	8	2
711.00.09	9	2
711.00.10	10	2
711.00.11	11	1
711.00.12	12	1
711.00.14	14	1

Compression plates 4,5 mm broad	(x)	Qty
711.01.08	8	1
711.01.09	9	1
711.01.10	10	1
711.01.11	11	1
711.01.12	12	1
711.01.14	14	1
711.01.16	16	1

Semi tubular plates 4,5 mm	(x)	Qty
711.02.04	4	4
711.02.05	5	4
711.02.06	6	4
711.02.07	7	4

T-Plates, large 4,5 mm	(x)	Qty
711.05.04	4	1
711.05.06	6	1
711.05.08	8	1

Spoon plates 4,5 mm	(x)	Qty
711.09.05	5	1
711.09.06	6	1

L-Plate for left leg 4,5 mm	(x)	Qty
711.07.04	4	1

L-Plate for right leg 4,5 mm	(x)	Qty
711.06.04	4	1

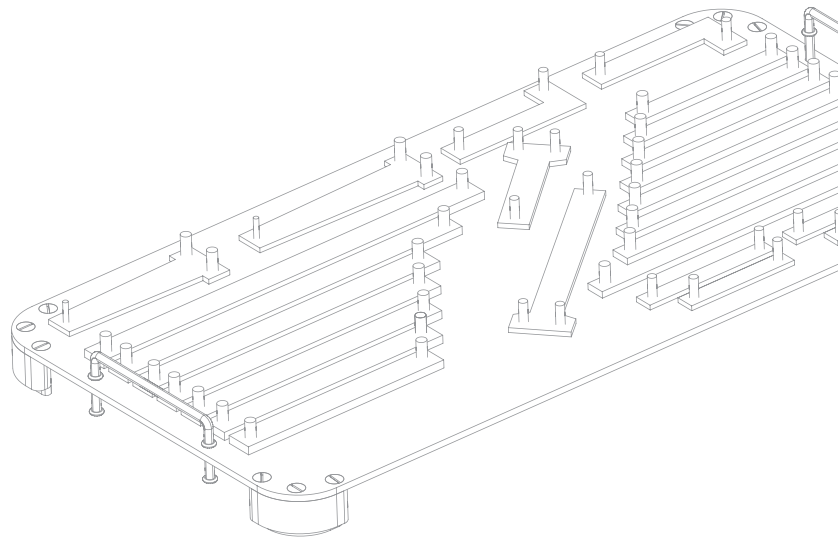

49.50.15	Medicontainer · 290 x 290 x 150 mm · silver	1
711.30.55	Large Fragment tray for screws only	1
49.60.13	Medicontainer · 590 x 290 x 135 mm · silver	1
49.97.21	Wire basket · 510 x 255 x 50 mm	1
711.30.60	Large fragment tray for plates only	1

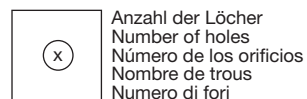

ORTHO PAEDICS

IMPLANTS AND INSTRUMENTS

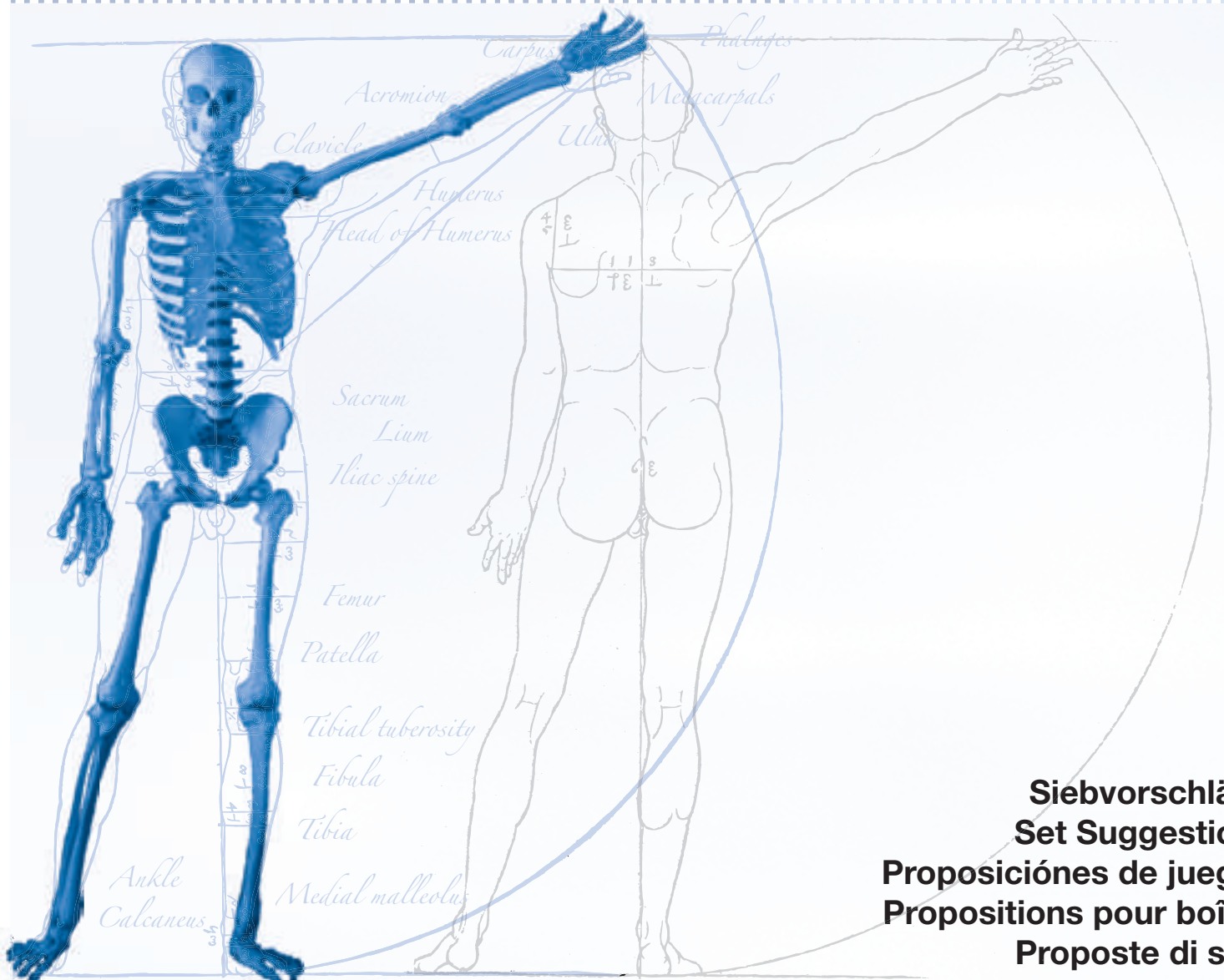

Siebvorschläge
Set Suggestions
Proposiciones de juegos
Propositions pour boîtes
Proposte di sets



Grundsieb Knochen
Basic Set Bone
Juego básico para huesos
Boîte de base à os
Set di base per ossa

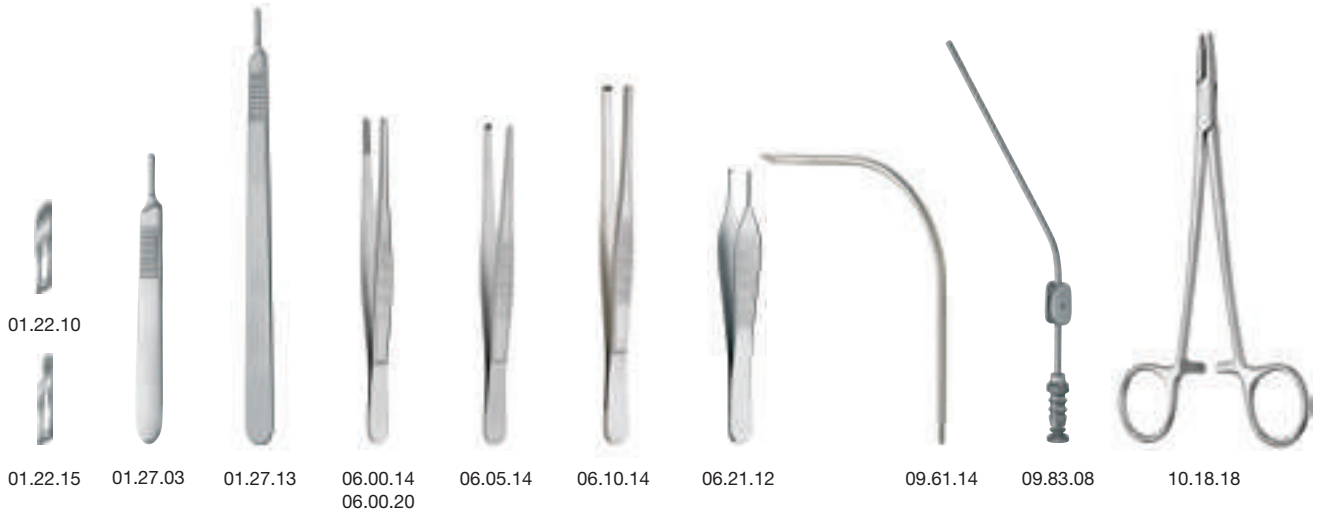



Grundsieb Knochen
Basic Set Bone
Juego básico para huesos
Boîte de base à os
Set di base per ossa

Part 1

Item number	Description	Quantity
01.22.10	Scalpel blade · fig 10 · sterile · packing unit 100 pieces	1
01.22.15	Scalpel blade · fig 15 · sterile · packing unit 100 pieces	1
01.27.03	Scalpel handle · no 3 · standard · 12.5 cm	1
01.27.13	Scalpel handle · no 3L · long · 21 cm	1
06.00.14	Dressing forceps · 14.5 cm · standard	2
06.00.20	Dressing forceps · 20.0 cm · standard	2
06.05.14	Tissue forceps · 14.5 cm · 1 × 2 teeth · standard	2
06.10.14	Tissue forceps · 14.5 cm · 2 × 3 teeth	2
06.21.12	ADSON Tissue forceps · 12 cm · 1 × 2 teeth · smooth	2
09.61.14	REDON Guide needle · curved · 14 French	2
09.83.08	FRAZIER Suction cannula · 8 French · angled · 12.5 cm	1
10.18.18	MAYO-HEGAR Needle holder · 18 cm	2
14.23.62	UNIVERSAL HM Wire cutting scissors · 12 cm	1
14.48.04	Wire twisting forceps · 18 cm · round	1
15.44.12	HALSTED-MOSQUITO Forceps · 12.5 cm · straight	4
15.45.12	HALSTED-MOSQUITO Forceps · 12.5 cm · curved	4
15.70.14	KELLY Hemostatic forceps · 14 cm · straight	4
15.71.14	KELLY Hemostatic forceps · 14 cm · curved	4
16.11.16	ROCHESTER-PEAN Hemostatic forceps · 16 cm · curved	2
16.12.16	ROCHESTER-OCHSNER Hemostatic forceps · 1 × 2 teeth · 16 cm · straight	2
16.12.20	ROCHESTER-OCHSNER Hemostatic forceps · 1 × 2 teeth · 20 cm · straight	1
17.55.13	BACKHAUS Towel clamp · 13.0 cm	6
17.57.14	EDNA (LORNA) Towel clamp · 14 cm	2
19.50.24	FOERSTER Sponge forceps · 24 cm · straight	6
22.34.01	VOLKMANN Retractor · 1 tooth · sharp · 22 cm	1
22.34.04	VOLKMANN Retractor · 4 teeth · sharp · 18 mm · 22 cm	2
22.35.04	VOLKMANN Retractor · 4 teeth · blunt · 18 mm · 22 cm	2
22.72.04	ISRAEL Retractor · 4 teeth · blunt · 40 × 40 mm · 25 cm	2





Grundsieb Knochen
Basic Set Bone
Juego básico para huesos
Boîte de base à os
Set di base per ossa



23.63.80



26.29.07



26.60.35



26.64.26



26.64.84



26.08.77



27.95.16
27.95.17



27.95.20



28.44.10
28.44.15



28.45.20



28.61.08
28.61.10



28.62.06
28.62.10



28.64.20
28.64.30



28.65.20



29.56.51
29.56.54



30.38.69



31.07.05



33.20.17



35.11.17



35.14.16
35.14.22



35.15.18



35.16.21



35.20.20



Grundsieb Knochen
Basic Set Bone
Juego básico para huesos
Boîte de base à os
Set di base per ossa

Part 2

Item number	Description	Quantity
23.63.80	HIBBS Retractor · toothed · set/2	1
26.29.07	LANGENBECK Elevator · 7 mm · 20 cm	1
26.60.35	LANGENBECK Raspatory · 15 mm · 19 cm	1
26.64.26	Raspatory · 6 mm · 18.5 cm	1
26.64.84	Raspatory · 14 mm · 20 cm · straight	1
27.08.77	OMBREDANNE Metal mallet · 770 g · 23 cm	1
27.95.16	CASPAR Pestle · Ø 5 mm · 20 cm	1
27.95.17	CASPAR Pestle · Ø 8 mm · 20 cm	1
27.95.20	CASPAR Pestle · Ø 12 mm · 20 cm	1
28.44.10	STILLE Osteotome · 10 mm · 20 cm	1
28.44.15	STILLE Osteotome · 15 mm · 20 cm	1
28.45.20	STILLE Gouge · 20 mm · 20 cm	1
28.61.08	MINI-LEXER Chisel · 8 mm · 18 cm	1
28.61.10	MINI-LEXER Chisel · 10 mm · 18 cm	1
28.62.06	MINI-LEXER Gouge · 6 mm · 18 cm	1
28.62.10	MINILEXER Gouge · 10 mm · 18 cm	1
28.64.20	LEXER Chisel · 20 mm · 22 cm	1
28.64.30	LEXER Chisel · 30 mm · 22 cm	1
28.65.20	LEXER Gouge · 20 mm · 22 cm	1
29.56.51	BRUNS Sharp curette · fig 1 · 27 cm	1
29.56.54	BRUNS Sharp curette · fig 4 · 27 cm	1
30.38.69	OLIVECRONA Bone rongeur · curved · 20 cm	1
31.07.05	RUSKIN Bone rongeur · 5 mm · curved · 18 cm	1
33.20.17	LISTON Bone cutting forceps · 17 cm · straight	1
35.11.17	KISTLER-MANUS Repositions forceps · 15.5 cm	1
35.14.16	Bone holding clamp · 16 cm	1
35.14.22	Bone holding clamp · 22 cm	1
35.15.18	DINGMAN Bone holding forceps · 19 cm	1
35.16.21	Malleolar holding clamp · 21 cm	1
35.20.20	Bone holding forceps · delicate · 20 cm · straight	1





Grundsieb Knochen
Basic Set Bone
Juego básico para huesos
Boîte de base à os
Set di base per ossa



35.45.78



35.52.21



35.75.17



35.75.25



44.37.20



47.20.25



50.02.16



52.72.05



76.45.10



76.45.75



76.45.85



76.59.15



77.10.10



Grundsieb Knochen
Basic Set Bone
Juego básico para huesos
Boîte de base à os
Set di base per ossa

Part 3

Item number	Description	Quantity
35.45.78	ULRICH Bone holding clamp · 28 cm · curved	1
35.52.21	FERGUSSON Bone holding clamp · 21 cm	1
35.75.17	VERBRUGGE Bone holding clamp · 17.5 cm	1
35.75.25	VERBRUGGE Bone holding clamp · 25 cm	1
44.37.20	Ruler · stainless steel · 20 cm	1
47.20.25	Kidney basin · 250 × 125 × 35 mm	1
50.02.16	ALLIS Grasping forceps · 15 cm · 5 × 6 teeth	4
52.72.05	SIMON Scoop · rigid · 29 cm · fig 5	1
76.45.10	Wire extraction pliers · serrated · 17 cm	1
76.45.75	GOLIATH HM Wire and plate cutting plier · 25 cm	1
76.45.85	EASY CUT HM Wire and pin cutter · 20 cm	1
76.59.15	Bone reamer · 15 cm · T handle	1
77.10.10	DINGMAN Bone hook · 10 mm · 19 cm	1





Grundsieb Knochen
Basic Set Bone
Juego básico para huesos
Boîte de base à os
Set di base per ossa



77.10.95



77.11.10
77.11.18



77.11.24



77.11.42
77.11.65



203.06.14



203.50.67



203.51.67



204.33.68



49.60.22



49.95.76



49.97.21
49.97.22



Grundsieb Knochen
Basic Set Bone
Juego básico para huesos
Boîte de base à os
Set di base per ossa

Part 4

Item number	Description	Quantity
77.10.95	Bone lever · 25 mm · 27 cm	2
77.11.10	HOHMANN Bone lever · 10 mm · 22 cm	2
77.11.18	HOHMANN Bone lever · 18 mm · 24 cm	2
77.11.24	HOHMANN Bone lever · 24 mm · 26 cm	2
77.11.42	VERBRUGGE-HOHMANN Bone lever · 42 mm · 24 cm	2
77.11.65	VERBRUGGE-HOHMANN Bone lever · 65 mm · 25 cm	2
203.06.14	SC Operating scissors · straight · 14.5 cm · sharp / blunt	1
203.50.67	MAYO SC PLUS Scissors · straight · 17.0 cm	1
203.51.67	MAYO SC PLUS Scissors · curved · 17.0 cm	2
204.33.68	METZENBAUM SC PLUS Scissors · curved · 18 cm	1
49.60.22	Medicontainer · 590 x 290 x 220 mm · silver	1
49.92.63	Identification label red · engraved · 50 x 17.5 mm	1
49.95.76	Wrapping drape · 140 x 100 cm	1
49.97.21	Wire basket · 510 x 255 x 50 mm	1
49.97.22	Wire basket · 510 x 255 x 70 mm	2



Grundsieb Trauma
Basic Set Trauma
Juego básico para trauma
Boîte de base a trauma
Set di base per trauma

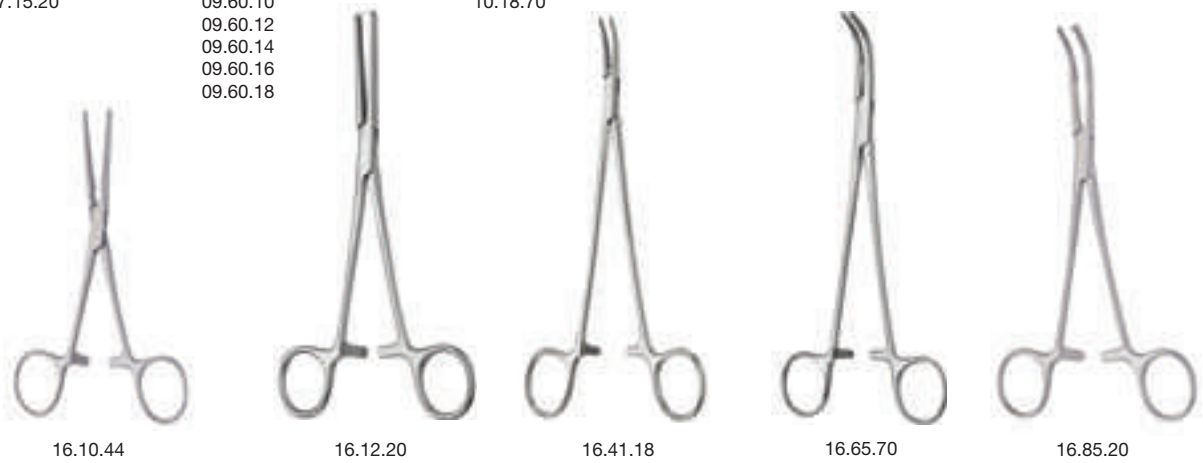
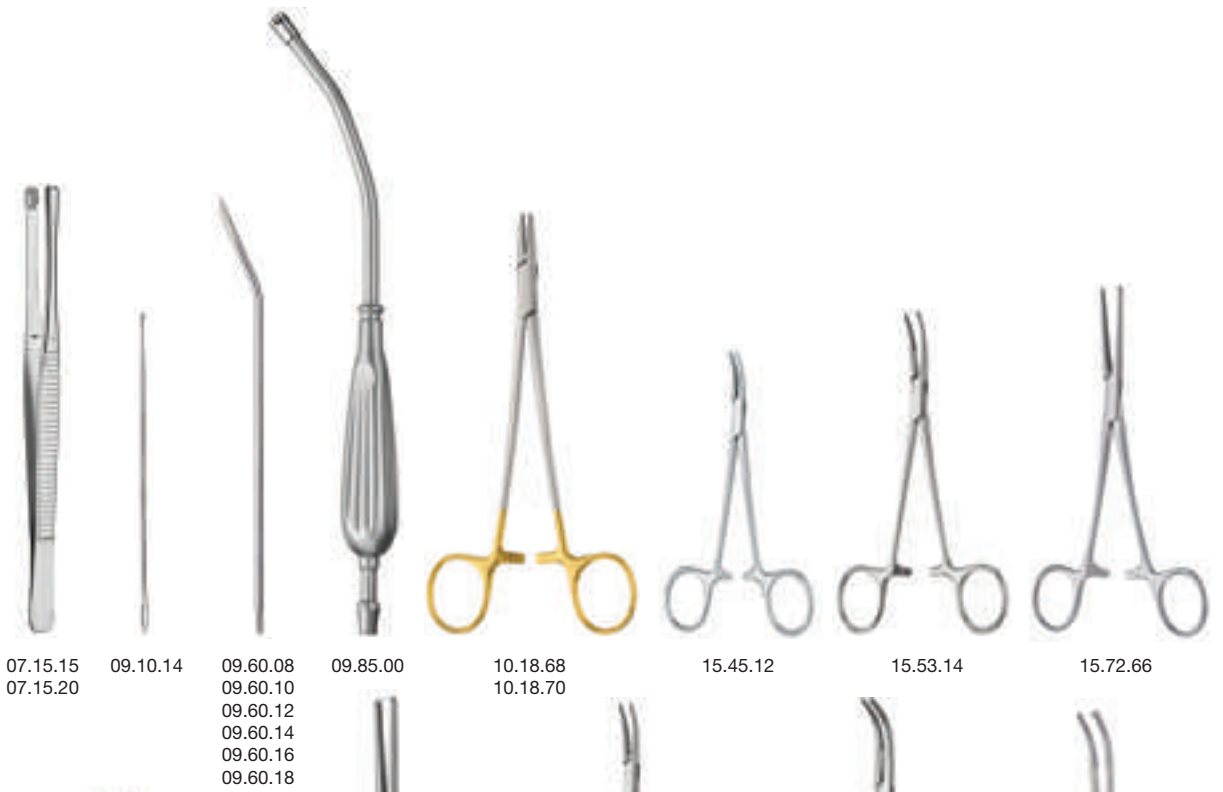



Grundsieb Trauma
Basic Set Trauma
Juego básico para trauma
Boîte de base a trauma
Set di base per trauma

Part 1

Item number	Description	Quantity
01.22.10	Scalpel blade · fig 10 · sterile · p/100	1
01.22.15	Scalpel blade · fig 15 · sterile · p/100	1
01.27.03	Scalpel handle · no 3 · standard · 12.5 cm	1
01.27.13	Scalpel handle · no 3L · long · 21 cm	1
06.00.14	Dressing forceps · 14.5 cm · standard	2
06.00.20	Dressing forceps · 20.0 cm · standard	2
06.05.14	Tissue forceps · 14.5 cm · 1 × 2 teeth · standard	2
06.10.14	Tissue forceps · 14.5 cm · 2 × 3 teeth	2
06.21.12	ADSON Tissue forceps · 12 cm · 1 × 2 teeth · smooth	2
09.61.14	REDON Guide needle · curved · 14 French	2
09.83.08	FRAZIER Suction cannula · 8 French · angled · 12.5 cm	1
10.18.18	MAYO-HEGAR Needle holder · 18 cm	2
14.23.62	UNIVERSAL HM Wire cutting scissors · 12 cm	1
14.48.04	Wire twisting forceps · 18 cm · round	1
15.44.12	HALSTED-MOSQUITO Forceps · 12.5 cm · straight	4
15.45.12	HALSTED-MOSQUITO Forceps · 12.5 cm · curved	4
15.70.14	KELLY Hemostatic forceps · 14 cm · straight	4
15.71.14	KELLY Hemostatic forceps · 14 cm · curved	4
16.11.16	ROCHESTER-PEAN Hemostatic forceps · 16 cm · curved	2
16.12.16	ROCHESTER-OCHSNER Hemostatic forceps · 1 × 2 teeth · 16 cm · straight	2
16.12.20	ROCHESTER-OCHSNER Hemostatic forceps · 1 × 2 teeth · 20 cm · straight	1
17.55.13	BACKHAUS Towel clamp · 13.0 cm	6
17.57.14	EDNA (LORNA) Towel clamp · 14 cm	2
19.50.24	FOERSTER Sponge forceps · 24 cm · straight	6
22.34.01	VOLKMANN Retractor · 1 tooth · sharp · 22 cm	1
22.34.04	VOLKMANN Retractor · 4 teeth · sharp · 18 mm · 22 cm	2
22.35.04	VOLKMANN Retractor · 4 teeth · blunt · 18 mm · 22 cm	2
22.72.04	ISRAEL Retractor · 4 teeth · blunt · 40 × 40 mm · 25 cm	2





Grundsieb Trauma
Basic Set Trauma
Juego básico para trauma
Boîte de base a trauma
Set di base per trauma



17.55.10

19.40.26

20.12.75

22.35.04
22.35.06
22.35.08

22.73.14

23.20.02
23.20.03

23.21.40

23.40.01

23.40.20



24.22.13

29.51.24
29.51.33
29.51.42
29.51.50
29.51.51
29.51.52
29.51.53
29.51.54
29.51.55
29.51.56

29.52.51
29.52.52
29.52.53

40.25.18

40.26.20



47.20.25



47.31.08

77.11.10
77.11.18

77.11.42

78.35.11



Grundsieb Trauma
Basic Set Trauma
Juego básico para trauma
Boîte de base a trauma
Set di base per trauma

Part 2

Item number	Description	Quantity
17.55.10	BACKHAUS Towel clamp · 10.5 cm	6
19.40.26	ULRICH Cotton swab forceps · 26 cm · straight	2
20.12.75	STRANDELL-STILLE Retractor · 17 cm · 6 × 15 mm	2
22.35.04	VOLKMANN Retractor · 4 teeth · blunt · 18 mm · 22 cm	2
22.35.06	VOLKMANN Retractor · 6 teeth · blunt · 28 mm · 22 cm	2
22.35.08	VOLKMANN Retractor · 8 teeth · blunt · 40 mm · 22 cm	2
22.73.14	BILLROTH Retractor · 4 teeth · 50 × 45 mm · 25 cm	2
23.20.02	KOCHER Retractor · 12 × 45 mm · 21 cm	2
23.20.03	KOCHER Retractor · 12 × 65 mm · 21 cm	2
23.21.40	KOCHER Retractor · 40 × 75 mm · 23 cm	2
23.40.01	KOCHER Retractor · 12 × 19 mm · 20 cm	2
23.40.20	KOCHER Retractor · 20 × 38 mm · 23 cm	2
24.22.13	WEITLANER Retractor · 3 × 4 teeth · sharp · 13.0 cm	1
29.51.24	VOLKMANN Sharp curette · 17 cm · fig 4/0	1
29.51.33	VOLKMANN Sharp curette · 17 cm · fig 3/0	1
29.51.42	VOLKMANN Sharp curette · 17 cm · fig 2/0	1
29.51.50	VOLKMANN Sharp curette · 17 cm · fig 0	1
29.51.51	VOLKMANN Sharp curette · 17 cm · fig 1	1
29.51.52	VOLKMANN Sharp curette · 17 cm · fig 2	1
29.51.53	VOLKMANN Sharp curette · 17 cm · fig 3	1
29.51.54	VOLKMANN Sharp curette · 17 cm · fig 4	1
29.51.55	VOLKMANN Sharp curette · 17 cm · fig 5	1
29.51.56	VOLKMANN Sharp curette · 17 cm · fig 6	1
29.52.51	SCHEDE Sharp curette · 17 cm · fig 1	1
29.52.52	SCHEDE Sharp curette · 17 cm · fig 2	1
29.52.53	SCHEDE Sharp curette · 17 cm · fig 3	1
40.25.18	LISTER Bandage scissors · 18 cm	1
40.26.20	LISTER Bandage scissors · 20 cm · large ring	1
47.20.25	Kidney basin · 250 × 125 × 35 mm	2
47.31.08	Round bowl · 150 × 75 mm · 1.00 l	2
77.11.10	HOHMANN Bone lever · 10 mm · 22 cm	2
77.11.18	HOHMANN Bone lever · 18 mm · 24 cm	4
77.11.42	VERBRUGGE-HOHMANN Bone lever · 42 mm · 24 cm	2
78.35.11	Bone lever · 6 mm · 16 cm	2





Grundsieb Trauma
Basic Set Trauma
Juego básico para trauma
Boîte de base a trauma
Set di base per trauma



87.33.70



87.32.04



87.32.20



87.32.28



88.00.21



88.00.40



88.20.08



204.33.18



49.60.22



49.95.76



49.97.21
49.97.22



Grundsieb Trauma
Basic Set Trauma
Juego básico para trauma
Boîte de base a trauma
Set di base per trauma

Part 3

Item number	Description	Quantity
87.32.04	Spatula electrode · straight · Ø 4.0 mm	1
87.32.20	Wire loop electrode · Ø 5 mm · Ø 4.0 mm	1
87.32.28	Rollerball electrode · straight · Ø 4 mm · Ø 4.0 mm	1
87.33.70	Electrode handle · Ø 4.0 mm · with cable · 4.5 m	1
88.00.21	Bipolar cable · Ø 12.5 mm · 4 m	1
88.00.40	Bracket · for high frequency cables	1
88.20.08	Bipolar forceps · 20.0 cm · angled · blunt	2
204.33.18	METZENBAUM SC Scissors · curved · 18 cm	1
49.60.22	Medicontainer · 590 × 290 × 220 mm · silver	1
49.92.63	Identification label red · engraved · 50 x 17.5 mm	1
49.95.76	Wrapping drape · 140 x 100 cm	1
49.97.21	Wire basket · 510 × 255 × 50 mm	1
49.97.22	Wire basket · 510 × 255 × 70 mm	2



Metallentfernung
Removal of Plates and Screws
Remoción de metal
Extraction de métal
Rimozione delle placche e viti

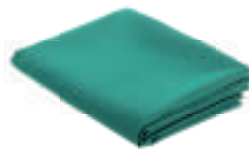
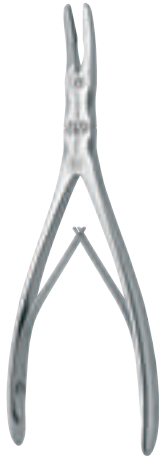



Metallentfernung
Removal of Plates and Screws
Remoción de metal
Extraction de métal
Rimozione delle placche e viti

Item number	Description	Quantity
01.22.10	Scalpel blade · fig 10 · sterile · p/100	1
01.22.22	Scalpel blade · fig 22 · sterile · p/100	1
01.27.03	Scalpel handle · no 3 · standard · 12.5 cm	1
01.28.04	Scalpel handle · no 4 · standard · 13.5 cm	2
06.05.14	Tissue forceps · 14.5 cm · 1 × 2 teeth · standard	2
09.60.12	REDON Guide needle · angled · 12 French	1
09.60.14	REDON Guide needle · angled · 14 French	1
09.85.00	YANKAUER Suction tube · 28 cm	1
19.17.26	MAIER Dressing forceps · 26 cm · curved	2
26.42.05	WILLIGER Raspatory · 5 mm · 16 cm	1
26.60.35	LANGENBECK Raspatory · 15 mm · 19 cm	1
31.07.25	RUSKIN Bone rongeur · 5 mm · curved · 24 cm	1
31.11.13	MARQUARDT Bone rongeur · curved · 20 cm	1
75.22.60	Screwdriver set · 1 handle, 8 blades	1
78.29.14	BUNNELL Dissecting probe · 16.5cm · angled	1
204.33.68	SC Plus Metzenbaum Scissors · curved · 18 cm	1
351.64.01	Cleaning hook	1
49.50.13	Medicontainer · 290 × 290 × 135 mm · silver	1
49.92.63	Identification label red · engraved · 50 x 17.5 mm	1
49.95.76	Wrapping drape · 140 x 100 cm	1
49.97.02	Wire basket · 240 × 255 × 50 mm	2



Ender Marknagelung
Ender Intramedullary Nailing
Ender fijación intramedular
Ender enclouage centromédullaire
Ender inchioldamento endomidollare



75.66.30 - 78.66.49



75.66.05



75.66.06



75.66.07



75.66.08



75.95.21



75.95.61



49.60.15



49.97.21



49.95.76



Ender Marknagelung
Ender Intramedullary Nailing
Ender fijación intramedular
Ender enclouage centromédullaire
Ender inchioldamento endomidollare

Item number	Description	Quantity
75.66.30	ENDER Intramedullary hook · Ø 4.5 mm · 30 cm	3
75.66.31	ENDER Intramedullary hook · Ø 4.5 mm · 31 cm	3
75.66.32	ENDER Intramedullary hook · Ø 4.5 mm · 32 cm	3
75.66.33	ENDER Intramedullary hook · Ø 4.5 mm · 33 cm	3
75.66.34	ENDER Intramedullary hook · Ø 4.5 mm · 34cm	3
75.66.35	ENDER Intramedullary hook · Ø 4.5 mm · 35 cm	3
75.66.36	ENDER Intramedullary hook · Ø 4.5 mm · 36cm	3
75.66.37	ENDER Intramedullary hook · Ø 4.5 mm · 37 cm	3
75.66.38	ENDER Intramedullary hook · Ø 4.5 mm · 38 cm	3
75.66.39	ENDER Intramedullary hook · Ø 4.5 mm · 39 cm	3
75.66.40	ENDER Intramedullary hook · Ø 4.5 mm · 40 cm	3
75.66.41	ENDER Intramedullary hook · Ø 4.5 mm · 41 cm	3
75.66.42	ENDER Intramedullary hook · Ø 4.5 mm · 42 cm	3
75.66.43	ENDER Intramedullary hook · Ø 4.5 mm · 43 cm	3
75.66.44	ENDER Intramedullary hook · Ø 4.5 mm · 44 cm	3
75.66.45	ENDER Intramedullary hook · Ø 4.5 mm · 45 cm	3
75.66.46	ENDER Intramedullary hook · Ø 4.5 mm · 46 cm	3
75.66.47	ENDER Intramedullary hook · Ø 4.5 mm · 47 cm	3
75.66.48	ENDER Intramedullary hook · Ø 4.5 mm · 48 cm	3
75.66.49	ENDER Intramedullary hook · Ø 4.5 mm · 49 cm	3
75.66.05	Inserting Instrument for 75.66.30 - 49	1
75.66.06	Impactor for 75.66.30 - 49	1
75.66.07	Impactor/extractor for 75.66.30 - 49	1
75.66.08	Extracting Instrument for 75.66.30 - 49	1
75.95.21	KÜNTSCHER Awl · Ø 8 mm · 28 cm	1
75.95.61	Protecting shield for skin and tissue	1
49.60.15	Medicontainer · 590 × 290 × 150 mm · silver	1
49.92.63	Identification label red · engraved · 50 x 17.5 mm	1
49.95.76	Wrapping drape · 140 x 100 cm	1
49.97.21	Wire basket · 510 × 255 × 50 mm	2



Basissieb Hüfte
Basic Set Hips
Set básico para cadera
Boîte générale pour hanche
Set di base per l'anca

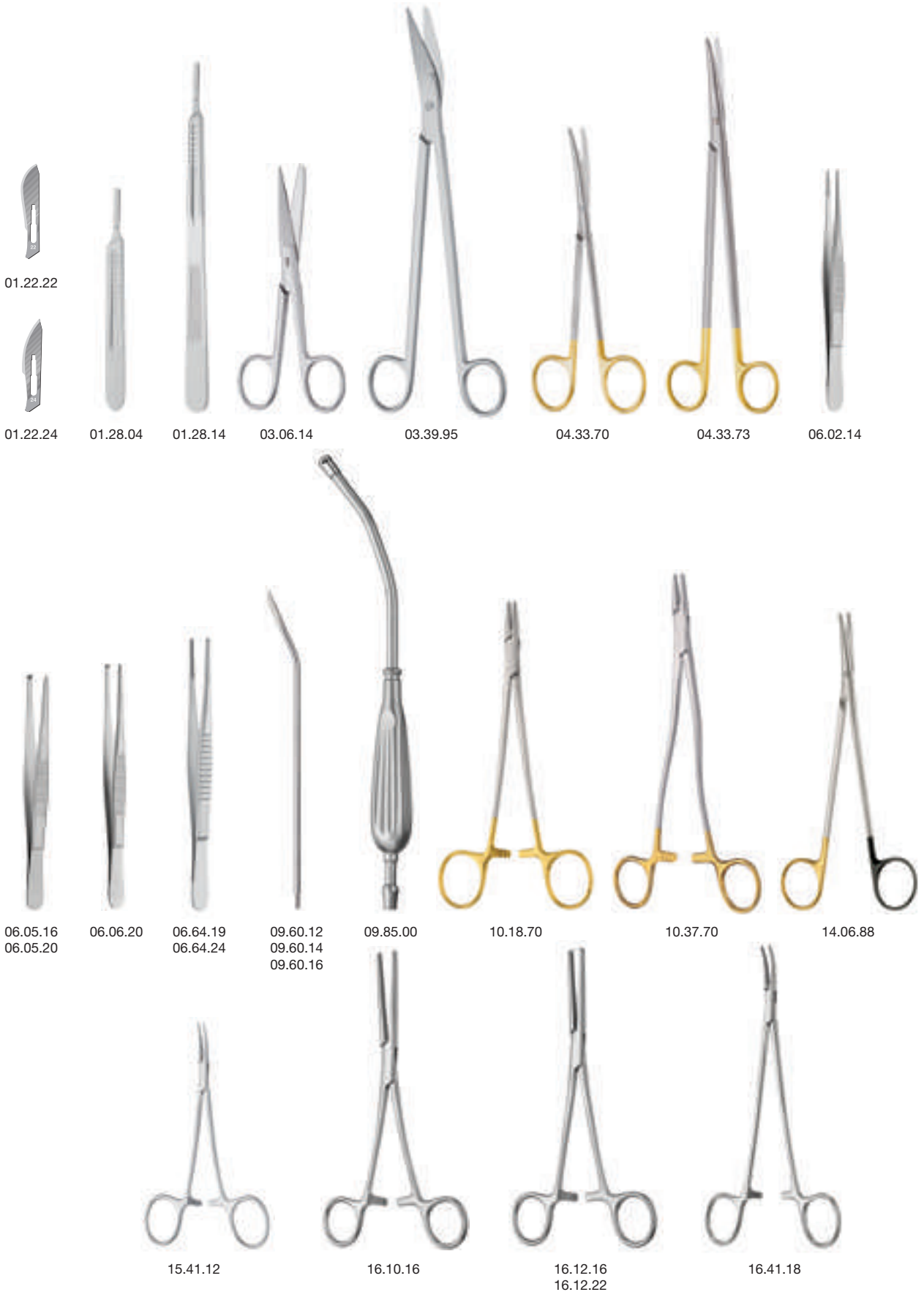



Basissieb Hüfte
Basic Set Hips
Set básico para cadera
Boîte générale pour hanche
Set di base per l'anca

Part 1

Item number	Description	Quantity
01.22.22	Scalpel blade · fig 22 · sterile · p/100	1
01.22.24	Scalpel blade · fig 24 · sterile · p/100	1
01.28.04	Scalpel handle · no 4 · standard · 13.5 cm	1
01.28.14	Scalpel handle · no 4L · long · 21 cm	1
03.06.14	Operating scissors · straight · 14.5 cm · sharp / blunt	1
03.39.95	RESANO Operating scissors · angled on flat · 25 cm	1
04.33.70	METZENBAUM HM Scissors · curved · 20 cm	1
04.33.73	NELSON-METZENBAUM HM Scissors · curved · 23 cm	1
06.02.14	Dressing forceps · 14.5 cm · slim	2
06.05.16	Tissue forceps · 16.0 cm · 1 × 2 teeth · standard	2
06.05.20	Tissue forceps · 20.0 cm · 1 × 2 teeth · standard	2
06.06.20	Tissue forceps · 20.0 cm · 1 × 2 teeth · medium	2
06.64.19	DEBAKEY AT Vascular forceps · 20 cm · 2.8 mm	2
06.64.24	DEBAKEY AT Vascular forceps · 24 cm · 2.8 mm	2
09.60.12	REDON Guide needle · angled · 12 French	1
09.60.14	REDON Guide needle · angled · 14 French	1
09.60.16	REDON Guide needle · angled · 16 French	1
09.85.00	YANKAUER Suction tube · 28 cm	1
10.18.70	MAYO-HEGAR HM Needle holder · 20 cm	2
10.37.70	BOZEMANN (WERTHEIM) HM Needle holder · 20 cm	1
14.06.88	HM Ligature scissors · 18.0 cm · curved	1
15.41.12	MICRO-HALSTED Hemostatic forceps · 12.5 cm · curved	6
16.10.16	ROCHESTER-PEAN Hemostatic forceps · 16 cm · straight	2
16.12.16	ROCHESTER-OCHSNER Hemostatic forceps · 1 × 2 teeth · 16 cm · straight	4
16.12.22	ROCHESTER-OCHSNER Hemostatic forceps · 1 × 2 teeth · 22 cm · straight	2
16.41.18	HALSTED (ADSON) Hemostatic forceps · 18 cm · curved	2





Basissieb Hüfte
Basic Set Hips
Set básico para cadera
Boîte générale pour hanche
Set di base per l'anca



16.65.72

17.55.10

19.16.26

19.17.26

22.16.16

22.43.06

22.56.08



22.72.06

23.25.12

23.69.05

26.29.10

26.60.35

26.67.34

26.76.07

27.10.70

27.95.17

27.95.20



Basissieb Hüfte
Basic Set Hips
Set básico para cadera
Boîte générale pour hanche
Set di base per l'anca

Part 2

Item number	Description	Quantity
16.65.72	OVERHOLT-GEISSENDOERFER Forceps · 22.5 cm	1
17.55.10	BACKHAUS Towel clamp · 10.5 cm	12
19.16.26	MAIER Dressing forceps · 26 cm · straight	2
19.17.26	MAIER Dressing forceps · 26 cm · curved	2
22.16.16	ROUX Retractor · 16.5 cm · fig 3	2
22.43.06	KOCHER Retractor · 6 teeth · blunt · 28 mm · 22 cm	2
22.56.08	KOERTE Retractor · 8 teeth · sharp · 24 cm	2
22.72.06	ISRAEL Retractor · 6 teeth · blunt · 60 × 50 mm · 25 cm	2
23.25.12	LANGENBECK-KOCHER Retractor · 20 × 60 mm · 21 cm	2
23.69.05	MICULICZ Retractor · 55 × 85 mm · 25.5 cm	2
26.29.10	LANGENBECK Elevator · 10 mm · 20 cm	1
26.60.35	LANGENBECK Raspatory · 15 mm · 19 cm	1
26.67.34	WAGNER Raspatory · 17 mm · 33 cm	1
26.76.07	SEMB Raspatory · 23 cm · fig 7	1
27.10.70	WAGNER Mallet · Ø 35 mm · 162/360 g · set complete	1
27.95.17	CASPAR Pestle · Ø 8 mm · 20 cm	1
27.95.20	CASPAR Pestle · Ø 12 mm · 20 cm	1





Basissieb Hüfte
Basic Set Hips
Set básico para cadera
Boîte générale pour hanche
Set di base per l'anca



28.44.60
28.44.65

28.64.20
28.64.25
28.64.30

28.65.80
28.65.85

28.65.93

28.94.30

29.57.53
29.57.56

31.07.25

35.21.25

35.50.21



46.37.51

47.20.25

47.31.06
47.31.08

76.59.22

77.10.20



Basissieb Hüfte
Basic Set Hips
Set básico para cadera
Boîte générale pour hanche
Set di base per l'anca

Part 3

Item number	Description	Quantity
28.44.60	STILLE Osteotome · curved · 10 mm · 20 cm	1
28.44.65	STILLE Osteotome · curved · 15 mm · 20 cm	1
28.64.20	LEXER Chisel · 20 mm · 22 cm	1
28.64.25	LEXER Chisel · 25 mm · 22 cm	1
28.64.30	LEXER Chisel · 30 mm · 22 cm	1
28.65.80	LEXER Gouge · 10 mm · curved · 25 cm	1
28.65.85	LEXER Gouge · 15 mm · curved · 25 cm	1
28.65.93	COBB Gouge · strong curved · 28 cm	1
28.94.30	LAMBOTTE Osteotome · straight · 30 mm · 24 cm	1
29.57.53	BRUNS Sharp curette · fig 3 · 33 cm	1
29.57.56	BRUNS Sharp curette · fig 6 · 33 cm	1
31.07.25	RUSKIN Bone rongeur · 5 mm · curved · 24 cm	1
35.21.25	BIRCHER-GANSKE Cartilage clamp · 20 cm	1
35.50.21	LANGENBECK Bone holding clamp · 20 cm	1
46.37.51	Inner case · only · for 46.37.50	1
47.20.25	Kidney basin · 250 × 125 × 35 mm	1
47.31.06	Round bowl · 110 × 55 mm · 0.40 l	1
47.31.08	Round bowl · 150 × 75 mm · 1.00 l	1
76.59.22	PERTHES Bone reamer · 22 cm · aluminum handle	1
77.10.20	DINGMAN Bone hook · 20 mm · 17 cm	1





Basissieb Hüfte
Basic Set Hips
Set básico para cadera
Boîte générale pour hanche
Set di base per l'anca



77.11.18



77.11.24
77.11.34



77.11.42
77.11.65



77.11.93



77.12.04



203.57.96



49.60.22



49.97.21
49.97.22



49.95.76



Basissieb Hüfte
Basic Set Hips
Set básico para cadera
Boîte générale pour hanche
Set di base per l'anca

Part 4

Item number	Description	Quantity
77.11.18	HOHMANN Bone lever · 18 mm · 24 cm	2
77.11.24	HOHMANN Bone lever · 24 mm · 26 cm	2
77.11.34	HOHMANN Bone lever · 34 mm · 29 cm	2
77.11.42	VERBRUGGE-HOHMANN Bone lever · 42 mm · 24 cm	2
77.11.65	VERBRUGGE-HOHMANN Bone lever · 65 mm · 25 cm	2
77.11.93	MURPHY-LANE Bone lever · 31 cm	1
77.12.04	BENNETT Bone lever · 45 mm · 24 cm	1
203.57.96	LEXER SC PLUS Scissors · curved · 16 cm	1
49.60.22	Medicontainer · 590 × 290 × 220 mm · silver	1
49.92.63	Identification label red · engraved · 50 x 17.5 mm	1
49.95.76	Wrapping drape · 140 x 100 cm	1
49.97.21	Wire basket · 510 × 255 × 50 mm	1
49.97.22	Wire basket · 510 × 255 × 70 mm	2



Hallux Valgus Korrektur
Hallux Valgus Correction
Corrección de los dedos de pie
Correction d'orteil
Correzione delle dita dei piedi



01.22.10



01.22.22



01.27.03



01.28.04



03.57.96



04.33.68



06.01.14



06.05.14



06.07.14



09.60.10



09.85.00



10.18.65
10.18.70



14.06.84



14.48.05



15.47.12



16.10.14



16.12.14



17.55.10



19.16.26



19.17.26



20.18.10



22.16.14



22.30.02



22.34.04



Hallux Valgus Korrektur
Hallux Valgus Correction
Corrección de los dedos de pie
Correction d'orteil
Correzione delle dita dei piedi

Part 1

Item number	Description	Quantity
01.22.10	Scalpel blade · fig 10 · sterile · p/100	1
01.22.22	Scalpel blade · fig 22 · sterile · p/100	1
01.27.03	Scalpel handle · no 3 · standard · 12.5 cm	1
01.28.04	Scalpel handle · no 4 · standard · 13.5 cm	1
03.57.96	LEXER HM Scissors · curved · 16 cm	2
04.33.68	METZENBAUM HM Scissors · curved · 18 cm	1
06.01.14	Dressing forceps · 14.5 cm · medium	2
06.05.14	Tissue forceps · 14.5 cm · 1 × 2 teeth · standard	2
06.07.14	Tissue forceps · 14.5 cm · 1 × 2 teeth · slim	2
09.60.10	REDON Guide needle · angled · 10 French	2
09.85.00	YANKAUER Suction tube · 28 cm	1
10.18.65	MAYO-HEGAR HM Needle holder · 15 cm	1
10.18.70	MAYO-HEGAR HM Needle holder · 20 cm	1
14.06.84	HM Ligature scissors · 14.5 cm · curved	1
14.48.05	Seizing forceps · double action · 5 mm · 18 cm	1
15.47.12	HALSTED-MOSQUITO forceps · 12.5 cm · curved · 1 × 2 teeth	8
16.10.14	ROCHESTER-PEAN Hemostatic forceps · 14 cm · straight	4
16.12.14	ROCHESTER-OCHSNER Hemostatic forceps · 1 × 2 teeth · 14 cm · straight	6
17.55.10	BACKHAUS Towel clamp · 10.5 cm	2
19.16.26	MAIER Dressing forceps · 26 cm · straight	2
19.17.26	MAIER Dressing forceps · 26 cm · curved	2
20.18.10	LOVE (MORSE) Retractor · 10 mm · 25 cm	2
22.16.14	ROUX Retractor · 14.0 cm · fig 1	2
22.30.02	VOLKMANN Retractor · 2 teeth · sharp · 9 mm · 21 cm	2
22.34.04	VOLKMANN Retractor · 4 teeth · sharp · 18 mm · 22 cm	2





Hallux Valgus Korrektur
Hallux Valgus Correction
Corrección de los dedos de pie
Correction d'orteil
Correzione delle dita dei piedi



22.35.02 22.42.01 23.05.14 26.29.07 26.64.26P 27.08.57 27.82.14 28.61.08P 28.64.15P 28.65.10P 29.51.51



30.71.02 31.05.03 31.07.05 33.21.17 33.21.22 35.11.13 46.37.51 76.16.03



Hallux Valgus Korrektur
Hallux Valgus Correction
Corrección de los dedos de pie
Correction d'orteil
Correzione delle dita dei piedi

Part 2

Item number	Description	Quantity
22.35.02	VOLKMANN Retractor · 2 teeth · blunt · 9 mm · 22 cm	2
22.42.01	KOCHER Retractor · 1 tooth · sharp · 22 cm	1
23.05.14	LANGENBECK Retractor · 14 × 28 mm · 21 cm	2
26.29.07	LANGENBECK Elevator · 7 mm · 20 cm	1
26.64.26	Raspatory · 6 mm · 18.5 cm	1
27.08.57	BERGMANN (HIBBS) Metal mallet · 540 g	1
27.82.14	WEST Gouge · straight · 4 mm · 16 cm	1
28.61.08	MINI-LEXER Chisel · 8 mm · 18 cm	1
28.64.15	LEXER Chisel · 15 mm · 22 cm	1
28.65.10	LEXER Gouge · 10 mm · 22 cm	1
29.51.51	VOLKMANN Sharp curette · 17 cm · fig 1	4
30.71.02	BEYER Bone rongeur · 2 mm · curved · 17 cm	1
31.05.03	RUSKIN-MINI Bone rongeur · 3 mm · curved · 15 cm	1
31.07.05	RUSKIN Bone rongeur · 5 mm · curved · 18 cm	1
33.21.17	LISTON Bone cutting forceps · 17 cm · curved	1
33.21.22	LISTON Bone cutting forceps · 22 cm · curved	1
35.11.13	Bone clamp · 13.5 cm ang	2
46.37.51	Inner case · only · for 46.37.50	1
76.16.03	KIRSCHNER Wire tube · 16 cm · Ø 12 mm	1





Hallux Valgus Korrektur
Hallux Valgus Correction
Corrección de los dedos de pie
Correction d'orteil
Correzione delle dita dei piedi



76.45.85



77.10.20



77.10.60



77.11.10



78.35.11



87.30.12
1:1



87.33.70



204.33.63



49.60.17



49.95.76



49.97.21



Hallux Valgus Korrektur
Hallux Valgus Correction
Corrección de los dedos de pie
Correction d'orteil
Correzione delle dita dei piedi

Part 3

Item number	Description	Quantity
76.45.85	EASY CUT HM Wire and pin cutter · 20 cm	1
77.10.20	DINGMAN Bone hook · 20 mm · 17 cm	1
77.10.60	LANGE-BABY Bone lever · 17 mm · 17 cm	2
77.11.10	HOHMANN Bone lever · 10 mm · 22 cm	2
78.35.11	Bone lever · 6 mm · 16 cm	2
87.30.12	Lancet electrode · straight · 25 mm	1
87.33.70	Electrode handle · Ø 4.0 mm · with cable · 4.5 m	1
204.33.63	METZENBAUM SC PLUS Scissors · curved · 14 cm	1
49.60.17	Medicontainer · 590 × 290 × 170 mm · silver	1
49.92.63	Identification label red · engraved · 50 x 17.5 mm	1
49.95.76	Wrapping drape · 140 x 100 cm	1
49.97.21	Wire basket · 510 × 255 × 50 mm	3



Orthopädie-Draht Set
Orthopaedics Wire Set
Set de alambres ortopédicos
Jeu de fils orthopédique
Set di fili orthopedico



14.30.17



14.41.65



14.46.14



76.05.24
76.05.27



76.16.04



76.45.19



76.45.21



76.45.30



76.45.73



76.01.10
76.01.15



76.10.10
76.10.15
76.10.20
76.10.25



49.60.10



49.97.12



Orthopädie-Draht Set
Orthopaedics Wire Set
Set de alambres ortopédicos
Jeu de fils orthopédique
Set di fili orthopedico

Item number	Description	Quantity
14.30.17	HM wire cutter · 17,5 cm	1
14.41.65	HM wire twisting forceps · 15 cm	2
14.46.14	Flat nose pliers · 14 cm	1
76.05.24	Wire guide · 24 cm	1
76.05.27	Wire guide · 27 cm	1
76.16.04	Wire container · Ø 12 mm · 19 cm	4
76.45.19	Flat nose pliers · 19 cm	1
76.45.21	Wire and Nail Extracting Forceps · 20 cm	1
76.45.30	Wire and Nail Extracting Forceps · 18 cm	1
76.45.73	HM wire cutter · 23 cm	1
76.01.10	Bone suturing wire · soft · Ø 1 mm · 10 m	1
76.01.15	Bone suturing wire · soft · Ø 1.5 mm · 10 m	1
76.10.10	Kirschner wire · Ø 1 mm · 15 cm · p/100	10
76.10.15	Kirschner wire · Ø 1.5 mm · 15 cm · p/100	20
76.10.20	Kirschner wire · Ø 2.0 mm · 15 cm · p/100	10
76.10.25	Kirschner wire · Ø 2.5 mm · 15 cm · p/100	10
76.16.04	Wire container · Ø 12 mm · 19 cm	4
49.60.10	Medicontainer · 590 x 290 x 100 mm · silver	1
49.92.63	Identification label 50 x 17.5 mm · engraved · red	1
49.97.12	Wire basket · 480 x 255 x 50 mm	1

Siebsichtung
Set Checking
Servicio de revisión del instrumental quirúrgico
Contrôle des boîtes
Verifica dei set chirurgici



Wir bieten Krankenhäusern den Service von Siebsichtungen an. Leistungsumfang der Siebsichtung:

- ▶ Erfassung des gesamten Instrumentariums nach Quantität und Wert
- ▶ Standardisierung der Siebe respektive Ergänzung fehlender Instrumente
- ▶ Austausch oder Reparatur defekter Instrumente
- ▶ Erstellung von Übersichts- und Packlisten

We offer a set checking service for hospitals. Performance of the set checking service:

- ▶ Record of all instruments according to quantity and value
- ▶ Standardization of the sets and completion of missing instruments respectively
- ▶ Exchange or repair of defective instruments
- ▶ Compilation of summary or packing lists



Nosotros ofrecemos para hospitales un servicio de revisión del instrumental quirúrgico. Contenido del servicio:

- ▶ Registro de todos los instrumentos según cantidad y valor
- ▶ Estandarizar los set instrumentales y completar los instrumentos faltantes
- ▶ Cambio o reparación de instrumentos defectos
- ▶ Elaboración de listas de contenido y empaque

Nous offrons aux hôpitaux un service de contrôle des boîtes. Le contrôle des boîtes contient:

- ▶ Enregistrement et chiffrage de l'instrumentation complète selon quantité et valeur
- ▶ Standardisation des boîtes ou complément d'instruments manquants
- ▶ Echange ou réparation des instruments défectueux
- ▶ Mise en place de listes de contenu et d'emballage



Offriamo un servizio di verifica dei set chirurgici per gli ospedali. Interventi nella verifica dei set chirurgici:

- ▶ Raccolta dello strumentario secondo quantità e valore
- ▶ Standardizzazione dei set attraverso l'aggiunta degli strumenti mancanti
- ▶ Sostituzione o riparazione degli strumenti difettosi
- ▶ Stesura di un elenco del contenuto e dell'imballaggio

ORTHO PAEDICS

IMPLANTS AND INSTRUMENTS

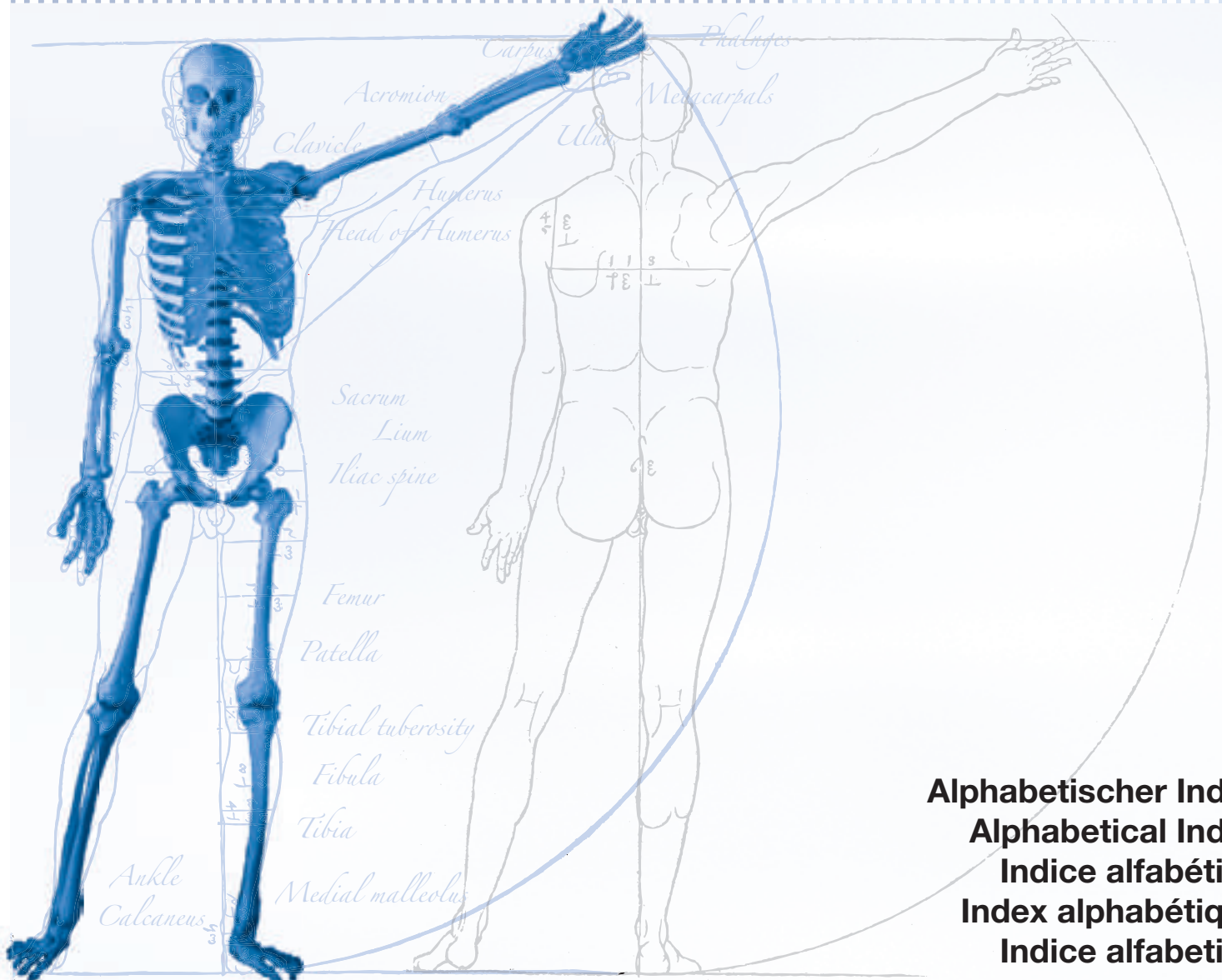

Alphabetischer Index
Alphabetical Index
Indice alfabético
Index alphabétique
Indice alfabetico

**Alphabetischer Index**

Alphabetical Index

Índice alfabético

Index alphabétique

Índice alfabético

A		
Abstützplatte für Repositionszangen	101	
ADSON Hohlmeißelzange	177	
ADSON Raspatorien	127	
ALEXANDER Flach- und Hohlmeißel	150	
Amputation	253-260	
Amputationsmesser	254-257	
Amputations-Reaktor	260	
Amputationssägen	258-259	
Ausschläger/Einschläger für Ender Nägel	215	
Ausschlaginstrument für Haken-Marknägel	218	
B		
BABY LANGE Knochenhebel	202	
BACON Hohlmeißelzange	178	
Bandmaße	211	
BANE Hohlmeißelzange	175	
Beckenhebel	102	
Beckeninstrumentarium	93-102	
Beckenrepositionszangen	98-100	
BEEBEE Drahtscheren	241	
Begrenzungsscheibe für Sägeblätter	278	
BENNET Elevatorium	123	
BENNETT Knochenhebel	207	
BERGMANN (HIBBS) Hammer	141	
BERGMANN Verbandschere	266	
BEYER Hohlmeißelzangen	177, 181	
Biegebolzen für Kirschner Bohrdrähte, Kleinfragment	57	
Biegebolzen für Kirschner Bohrdrähte, Minifragment	36	
Biegeeisen für Platten, Großfragment	82	
Biegeeisen für Platten, Kleinfragment	57	
Biegeeisen für Platten, Minifragment	35	
Biegeeisen für Rekonstruktionsplatten	96	
Biegehebel für Ender Nägel	215	
Biegepresse für Knochenplatten, Großfragment	83	
Biegeschablonen für Platten, Großfragment	83	
Biegeschablonen für Platten, Kleinfragment	57	
Biegeschablonen für Rekonstruktionsplatten	97	
Biegezange für Miniplatten	36	
BIER Amputationssäge	259	
BIRCHER-GANSKE Knochenhaltezege	194	
BIRCHER Knochenhaltezege	194	
BLACK Knochenfeilen	118	
BLOUNT Knochenhebel	208	
BLOUNT Knochenklammern	251	
BLUMENTHAL Hohlmeißelzangen	175	
BÖHLER Extensionsbügel	230	
BÖHLER WOLFF Gipsabreißzangen	272	
Bohrbuchsen DHPS	10-11	
Bohrbuchsen für kanülierte Schrauben	107, 112, 116	
Bohrbuchsen Großfragment	78-79	
Bohrbuchsen Kleinfragment	53-54	
Bohrbuchsen Minifragment	29	
Bohrdrahtbehälter	224	
Bohrer DHPS	10	
Bohrer für kanülierte Schrauben	106, 111, 115	
Bohrer für Titan Kreuzschlitzschrauben	44	
Bohrer Großfragment	76	
Bohrer Kleinfragment	51	
Bohrer Minifragment	27	
Bohrer Rekonstruktion	93	
Bohrlochtiefenlehre DHPS	12	
Bohrlochtiefenlehre Großfragment	82	
Bohrlochtiefenlehre Kleinfragment	56	
Bohrlochtiefenlehren Minifragment	34	
Bohrlochtiefenlehre Rekonstruktion	96	
Bolzenschneider	248	
BRISTOW Raspatorium	129	
BRÜNINGS Flach- und Hohlmeißel	148	
BRUNS Scharfe Löffel	165, 169	
BRUNS Verbandscheren	267	
BUCK-GRAMCKO Knochenhebel	201	
BUCK Scharfe Löffel	165	
BUNNELL Handbohrapparat	286	
C		
CASPAR Stößel	149	
CATLIN Amputationsmesser	257	
CHAMPIONNIERE Knochenbohrer	200	
CHARRIERE Amputationssäge	258	
CLEVELAND Knochensplitterzange	186	
COBB Hohlmeißel	155	
COBB Raspatorien	133	
COHEN Elevatorium	123	
COLLIN Amputationsmesser	257	
COLLIN FARABEUF Raspatorien	128	
COLLIN (LUCAE) Hammer	139	
CORWIN-HEGAR HM Drahtspannzange	238	
COTTLE-KAZANJIAN Knochensplitterzange	186	
COTTLE-MEDICON Flachmeißel	147	
CUSHING Raspatorien	130	
D		
DAHMEN Flach- und Hohlmeißel	157-158	
DAUBENSPECK Scharfe Löffel	164	
DEFOURMENTEL Hohlmeißelzange	178	
DELIMA HARDT Flachmeißel	145	
DEMEL Drahtspanninstrument	234	
DEMEL Drahtumführungsadnln	232	
DHPS Instrumentarium / Set	5-12 / 292	
DHPS Platten	2-3	
DHPS Schrauben	4	
DINGMAN Knochenhaltezege	192	
DINGMAN Knochenhebel	202	
Direktes Messgerät DHPS	6	
Doppelbohrbuchsen DHPS	10-11	
Doppelbohrbuchsen für kanülierte Schrauben	107, 112, 116	
Doppelbohrbuchsen Großfragment	78-79	
Doppelbohrbuchsen Kleinfragment	53	
Doppelbohrbuchsen Minifragment	29	
DOYEN Hammer	139	
Draht- und Drahtinstrumente	220-248	
Draht- und Plattenschneidezange HM	37, 58	
Drahtextraktionszangen	239-240	
Drahtkneifzangen	243-248	
Drahtkneifzangen HM	243-247	
Drahtscheren	241-243	
Drahtscheren HM	242-243	
Drahtspanninstrumente	234-235	
Drahtspannzangen	236-238	
Drahtspannzangen HM	236, 238	
Drahtumführungsadnln	232-233	
Dreistufenbohrer für DHPS Platten	6	
Drittelrohrplatten Kleinfragment	46	
E		
EASY CUT HM Drahtkneifzange	246	
ECHLIN Hohlmeißelzangen	185	
Ein- und Ausschlaginstrument für Haken-Marknägel	218	
Einbringinstrument für Ender Nägel	214	
Einsätze für Handbohrapparate	283, 285, 288	
Einschläger für Ender Nägel	214	
Einschläger/Ausschläger für Ender Nägel	215	
Einschlaginstrument DHPS	9	
Einschlaginstrumente für Knochenklammern	251	
Elektrische oszillierende Verbandsägen	274-276, 280-281	
Elevatorien	121-123	
ENDER Marknägel	214	
ENDER Marknagelung	214-215	
ENGEL Gipsäge	271	
Ersatz Papiersack für Staubsauger Osci-Clean	282	
Ersatzblätter für Amputationssägen	258-259	



Alphabetischer Index
Alphabetical Index
Indice alfabetico
Index alphabétique
Indice alfabetico

Ersatzklingen für Gipsscheren	269-270
ESMARCH Gipsmesser	271
ESMARCH Verbandscheren	266
EXCENTRIC LISTER Verbandscheren	264
Extensionsbügel	225-230
Extraktionsinstrument für Ender Nägel	215

F	
FARABEU-F-COLLIN Raspatorien	128
FARABEU Knochenhaltezeugen	198
FARABEU-LAMBOTTE Becken-repositionszange	99
FARABEU Raspatorien	128
FARABEU-LAMBOTTE Knochenhaltezeuge	198
Fasszangen	193-194
Femurplatten Großfragment	67
FERGUSSON Knochenhaltezeuge	198
Finger-Goniometer	212
Fixierscheiben für Bohrdrähte	228
Fixierzwinge für Spannschlüssel	229
Flach- und Hohlmeißel	146-161
Flach- und Hohlmeißel mit auswechselbaren Klingen	160-161
Flachmeißelklingen	160
Flachzangen	37, 58, 236-237
Fräser für Handbohrapparate	285
FREER Elevatorien	122
FREER Flachmeißel	147
FRIEDMANN Hohlmeißelzange	174
Führungsdraht DHPS	6
Führungsschaft DHPS	9

G	
Gabelschlüssel für elektrische oszillierende Verbandsägen	274, 276, 279
Gabelschlüssel für Plattenspanner	54, 80
GALLAHER Knochenfeilen	118
GANSKE BIRCHER Knochenhaltezeuge	194
GEIGER Hohlmeißelzange	180
GERZOG Hammer	140
Gewindeschneider DHPS	7, 10
Gewindeschneider für Kortikalisschrauben, Rekonstruktion	93
Gewindeschneider Großfragment	76-77
Gewindeschneider Kleinfragment	51-52
Gewindeschneider Minifragment	27
Gips- und Verbandinstrumente	262-272
Gipsabreißzangen	272
Gipsmesser	271
Gipssäge	271

Gipsscheren	269-270
Gipsspreizer	272
GOLIATH HM Drahtkneifzange	247
Goniometer	212
GRAMCKO BUCK Knochenheber	201
Großfragment / Set	61-84 / 298-300
Großfragment-Instrumentarium	76-84
Großfragmentplatten	62-70
Großfragmentschrauben	71-74

H	
HAJEK Hammer	139
Haken-Marknägel	216-218
Halbrohrplatten Großfragment	63
HALLE Scharfe Löffel	170
Haltehülse für kanülierte Schrauben	108, 112, 116
Haltehülse für Schrauben DHPS	12
Haltehülsen für Schrauben Großfragment	82
Haltehülsen für Schrauben Kleinfragment	56
Haltehülsen für Schrauben Minifragment	32-33
Haltehülsen für Schrauben Rekonstruktion	95
Haltezeugen für Platten Minifragment	38
Hämmer	139-144
Handbohrapparate	283-289
Handbohrer	231
Handgriffe mit Schnellkupplung	30, 106
HARDT-DELIMA Flachmeißel	145
HARMS HM Drahtkneifzange	247
HARTMANN Hohlmeißelzange	176
HARVEY Drahtschere	243
HEGAR CORWIN HM Drahtspannzange	238
HEMINGWAY Scharfe Löffel	172
HENAHAN Elevatorien	121
HENNIG Gipsspreizer	272
HERNANDEZ-ROS Klammerhalter	250
HERNANDEZ-ROS Klammerheber	250
HERNANDEZ-ROS Klammerstößel	250
HIBBS BERGMANN Hammer	141
HIBBS Flach- und Hohlmeißel	152
HM Drahtkneifzangen	243-247
HM Drahtscheren	241-243
HM Drahtspannzangen	236, 238
HM Platten- und Drahtschneidezange	37, 58
HOEN Elevatorien	121
Hohlmeißel	146-156, 158-161
Hohlmeißelklingen	161
Hohlmeißelzangen	174-185
HOHMANN Knochenheber	205
HOHMANN LANGE Knochenheber	203
HOHMANN LANGE MODIF. Knochenheber	204

HOHMANN VERBRUGGE Knochenheber	206
HOPKINS Gipsmesser	271
H-Platte Minifragment	14

I / J	
Instrumentarium für kanülierte Schrauben	106-108, 111-112, 115-116
Instrumente zur Marknagelung	214-218
JAMESON Schieblehre	212
JANSEN Hohlmeißelzangen	177-178
JANSEN Scharfe Löffel	171-172
JANSEN ZAUFAL Hohlmeißelzange	181
JOSEPH Knochenfeilen	118
JOSEPH Raspatorium	125

K	
KAHRE-WILLIGER Raspatorien	125
Kanülierte Schrauben	104-105, 109-110, 113-114
Kardanschlüssel für Plattenspanner	54, 80
KAZANJIAN COTTLE Knochensplitterzange	186
KERN Knochenhaltezeugen	195
KERPEL Scharfe Löffel	163
KEY LISTON Knochensplitterzange	189
KEY Raspatorien	129
KIRK Hammer	141
KIRMISSION Raspatorium	128
KIRSCHNER Bohrdrabtbehälter	224
KIRSCHNER Bohrdrähte	220-221
KIRSCHNER Extensionsbügel	226-228
KIRSCHNER MOD. USA Extensionsbügel	225
KISTLER-MANUS Knochenhaltezeuge	191
Klammerhalter	250
Klammerheber	250
Klammerinstrumente	250-251
Klammerstößel	250
Klammerung	249-251
Kleeblattplatten Kleinfragment	47
KLEINERT-KUTZ Hohlmeißelzangen	177, 179
Kleinfragment / Set	45-60 / 296-297
Kleinfragment-Instrumentarium	51-60
Kleinfragmentplatten	46-47
Kleinfragmentschrauben	48-49
Knochenbohrer	200
Knochendrähte	231
Knochenfeilen	118-120
Knochenhalteklammern	198
Knochenhaltetestab, Beckeninstrumentarium	101
Knochenhaltezeuge Minifragment	39
Knochenhaltezeugen	190-199
Knochenhaltezeugen Großfragment	84

**Alphabetischer Index**

Alphabetical Index

Índice alfabético

Index alphabétique

Índice alfabético

Knochenhalteclangen Kleinfragment	59-60
Knochenhebel	201-208
Knochenhebel Kleinfragment	60
Knochenhebel Minifragment	40
Knochenklammern	250-251
Knochenschrauben Kreuzschlitz	43
Knochensplitterclangen	186, 189
Knochenstopfer	148
Knorpelfassclangen	193-194
KNOWLES Verbandscleren	262
KÖNIG Raspatorium	124
Kompressionsplatten Großfragment	62
Kompressionsplatten Kleinfragment	46
Kompressionsplatten Minifragment	14, 17, 21
Kompressionsschraube DHPS	4
Kondylenabstützplatten Großfragment	66
Kondylenplatten Minifragment	15, 19, 24
Kopfraumfräser Großfragment	77-78
Kopfraumfräser kanüliert	106, 111, 115
Kopfraumfräser Kleinfragment	52
Kopfraumfräser Minifragment	28
Kortikalisschrauben Großfragment	71
Kortikalisschrauben Kleinfragment	48
Kortikalisschrauben Minifragment	16, 20, 25
Kortikalisschrauben Rekonstruktion	88, 90
KRÄMER Raspatorien	126
Kreuzschlitzschrauben	43
Kunststoffkoffer für Verbandsäge Oscillo Compact	281
KUTZ KLEINERT Hohlmeißelclangen	177, 179
L	
L-Abstützplatten Großfragment	64
LAMBOTTE FARABEUF Becken- repositionsclange	99
LAMBOTTE FARABEUF Knochenhalteclange	198
LAMBOTTE Flachmeißel	162
LAMBOTTE Knochenhebel	202
LAMBOTTE MINI Flachmeißel	145
LAMBOTTE Raspatorien	129
LANE Knochenhalteclangen	197
LANE Knochenhebel	202
LANE MURPHY Knochenhebel	207
LANGE-BABY Knochenhebel	202
LANGE-HOHMANN Knochenhebel	203
LANGE-HOHMANN MODIF. Knochenhebel	204
LANGE Knochenhebel	203
LANGE Verbandsclere	263
LANGENBECK Elevatorien	122
LANGENBECK Knochenhalteclange	197
LANGENBECK Lappenmesser	254

LANGENBECK Raspatorien	130
LANGENBECK Resektionsmesser	254, 255
LANGENBECK Stichsäge für die Amputation	258
Lappenmesser	254
LEKSELL Hohlmeißelclangen	184-185
LEMPERT Hohlmeißelclangen	179
LEMPERT Raspatorien	126
LEMPERT Scharfe Löffel	170
LEWIN Knochenhalteclange	191
LEXER Flach- und Hohlmeißel	154
LEXER Hohlmeißel	156
LEXER MINI Flach- und Hohlmeißel	153
LISTER-EXCENTRIC Verbandscleren	264
LISTER Verbandscleren	264-265
LISTON Amputationsmesser	255
LISTON-KEY Knochensplitterclange	189
LISTON Knochensplitterclangen	187
LISTON-MINI Knochensplitterclangen	187
LISTON Phalangenmesser	254
LISTON RUSKIN Knochensplitterclangen	188
LISTON-LITTAUER Knochensplitterclange	186
LISTON-STILLE Knochensplitterclangen	189
LITTAUER-LISTON Knochensplitterclange	186
Löffelplatten Großfragment	65
LORENZ Verbandsclere	263
LOUTE Drahtspanninstrument	234
LOWMAN Knochenhalteclammern	198
LOWMAN Knochenhalteclangen	198
L-Platten Minifragment	18-19, 22-23
LUCAE COLLIN Hammer	139
LUER Hohlmeißelclangen	175-176
LUER STILLE Hohlmeißelclangen	182
M	
MACDONALD Elevatorium	123
Malleolarschrauben Großfragment	74
MANUS KISTLER Knochenhalteclange	191
Marknagelung	214-218
MARQUARDT Hohlmeißelclange	182
MARTIN Knochenhalteclangen	193
MARTINI Scharfe Löffel	171
MCINDOE Knochensplitterclangen	188
MCKENTY Raspatorien	125
MEAD Hammer	140
MEAD Hohlmeißelclangen	174
MEAD Raspatorium	124
MEDICON COTTLE Flachmeißel	147
MEDICON Drahtspannzclange	236
MEDICON HM Drahtspannzclange	236
MEDICON Verbandsclere	268

Meniskusfassclangen	193-194
Messer Amputation	254-256
Messer Gips	271
Messer Resektion	254-255
Messgerät DHPS	6
Messinstrumente	211-212
MEYHOEFER Scharfe Löffel	163
MILLER Knochenfeilen	119
MINI-LAMBOTTE Flachmeißel	145
MINI-LEXER Flach- und Hohlmeißel	153
MINI LISTON Knochensplitterclangen	187
MINI RUSKIN Hohlmeißelclangen	179
MINI STILLE Gipssclere	269
Minifragment / Set	13-40 / 293-295
Minifragment-Instrumentarium	26-40
Minifragmentplatten	14-15, 17-19, 21-24
Minifragmentschrauben	16, 20, 25
MOD. USA Gipsspreizer	272
MÖLTGEN Winkelmesser	212
MOLT Raspatorien	124
MOORE Handbohrapparat	283
Motor-Systeme und Handbohrapparate	274-289
Multifragmentplatte Minifragment	23
MURPHY-LANE Knochenhebel	207

N

Nagelextraktionsclangen	239-240
NIRO Drahtspannzclangen	236
NIRO HM Drahtspannzclange	236
NIRO Knochensplitterclange	186

O

OLIVECRONA Hohlmeißelclange	176
OLIVECRONA Raspatorium	127
OMBREDANNE Hammer	142
OSCI-CLEAN Staubsauger für Gipssäge Oscillo Compact	282
OSCILLO COMPACT Elektrische oszillierende Verbandsclange	280-281
OSCILLO V Elektrische oszillierende Verbandsclange	276
Osteotomklingen	101
Oszillierende Verbandsclange	274-276, 280-281

P

Parallel Borbuchse Kleinfragment	54
Parallel Borbuchse Minifragment	29
PARTSCH Flach- und Hohlmeißel	146
PASSOW Knochenstopfer	148
PERCY Amputations-Retraktor	260
PERTHES Reibahlen	200



Alphabetischer Index
Alphabetical Index
Indice alfabetico
Index alphabétique
Indice alfabetico

PETERSEN SMITH Flach- und Hohlmeißel	159
PETERSEN SMITH Hohlmeißelzangen	180
Phalangenmesser	254
Platten DHPS	2-3
Plattenbiegezange für Rekonstruktionsplatten	96
Platten Großfragment	62-70
Platten Kleinfragment	46-47
Platten Minifragment	14-15, 17-19, 21-24
Platten Rekonstruktion	86-87
Platten Suprakondylär	3
Platten- und Drahtschneidezange HM	37, 58
Plattenspanner Großfragment	80
Plattenspanner Kleinfragment	54
PUTTI Knochenfeilen	118
R	
Radiusplatten	42
RALK Handbohrapparat	288
Raspatorien	124-138
Raspatorium Kleinfragment	59
Raspatorium Minifragment	39
Reibahlen	200
REINER Gipsmesser	271
Reinigungshaken	39, 58, 84
Rekonstruktion	85-92
Rekonstruktionsplatten	86-87
Rekonstruktionsschrauben	88-92
Repositionszangen Beckeninstrumentarium	98-100
Repositionszange Minifragment	38
Repositionszangen	191
Resektionsmesser	254-255
Ring-/Gabelschlüssel für Plattenspanner	54, 80
ROS HERNANDEZ Klammerhalter	250
ROS HERNANDEZ Klammerhebel	250
ROS HERNANDEZ Klammerstößel	250
ROWLAND RUSKIN Knochensplitterzangen	188
RUSKIN Hohlmeißelzangen	180, 181
RUSKIN-LISTON Knochensplitterzangen	188
RUSKIN-MINI Hohlmeißelzangen	179
RUSKIN-ROWLAND Knochensplitterzangen	188
RUST Amputationssäge	259
S	
Sägeblätter für elektrische oszillierende Verbandsägen	274, 276, 278-279, 281
SATTERLEE Amputationssäge	258
SCHANZ Schrauben	102, 224
Scharfe Löffel	163-173
SCHEDÉ Scharfe Löffel	167

SCHELL Hohlmeißelzange	175
Scheren Draht	241-243
Scheren Gips	269-270
Scheren Verband	262-268
Schieblehren	212
Schlüssel für DHPS Schrauben	8
Schrauben DHPS	4
Schrauben für Radiusplatten	43
Schrauben Großfragment	71-74
Schrauben kanüliert	104-105, 109-110, 113-114
Schrauben Kleinfragment	48-49
Schrauben Minifragment	16, 20, 25
Schrauben Rekonstruktion	88-92
Schraubendreher	209-210
Schraubendreher DHPS	11
Schraubendreher Großfragment	81-82
Schraubendreher kanüliert	107, 112, 116
Schraubendreher Kleinfragment	55
Schraubendreher Kreuzschlitz	44
Schraubendreher Minifragment	30-32
Schraubendreher Rekonstruktion	94-95
Schraubendreher Sechskant	11, 209-210
Schraubendrehereinsätze	209
Schraubendrehereinsätze Großfragment	81
Schraubendrehereinsätze Kleinfragment	55
Schraubendrehereinsätze Minifragment	31
Schraubendrehergriffe	44, 209
Schraubendrehergriffe Minifragment	30
Schraubendreherklinge für Kreuzschlitzschrauben	44
Schraubendreher-Satz	209
Schraubenhaltepinzette Minifragment	36
Schraubenhaltepinzette	12, 56, 108, 112
Schraubenschlüssel für Kirschner Extensionsbügel	229
SCHUKNECHT Drahtschere	242
SEBILEAU Elevatorium	121
SEDILLOT Raspatorien	127
Segmentsägeblatt	279
SEMB Knochenhalte-zangen	195
SEMB Raspatorien	138
SEMB-STILLE Hohlmeißelzangen	183
Sequesterzangen	190
Service Set für Staubsauger	277
SEUTIN Verbandschere	268
SHEEHAN Flach- und Hohlmeißel	146
SHERMAN STILLE Handbohrapparat	284
SIEBENMANN Scharfe Löffel	164
SMEDBERG Handbohrapparat	289

SMITH-PETERSEN Flach- und Hohlmeißel	159
SMITH-PETERSEN Hohlmeißelzangen	180
SMITH Verbandschere	262
Spannschlüssel für Handbohrapparate	286-289
Spannschlüssel für Kirschner Extensionsbügel	229
Spiralbohrer für Handbohrapparate	283, 285, 288
Spongiaschrauben Großfragment	72-73
Spongiaschrauben Kleinfragment	49
Spongiaschrauben Rekonstruktion	89, 91-92
SPRATT Scharfe Löffel	170
Stahllineale	211
Standardinstrumente	117-212
Staubsauger für Gipssägen	277, 282
Steckbohrbuchse Großfragment	78
Steckbohrbuchse Kleinfragment	53
STEINMANN Nägel	222-224
STELLBRINK Hohlmeißelzangen	179
Stichsägen für die Amputation	258
STILLE Flach- und Hohlmeißel	151
STILLE Gipsscheren	269-270
STILLE Handbohrapparat	284
STILLE Hohlmeißelzange	183
STILLE LISTON Knochensplitterzangen	189
STILLE-LUER Hohlmeißelzangen	182
STILLE-MINI Gipsschere	269
STILLE SEMB Hohlmeißelzangen	183
STILLE-SHERMAN Handbohrapparat	284
Suprakondyläre Platten	3
T	
T-Abstützplatten Großfragment	65
T-Griffe mit Schnell- kupplung	7, 11, 55, 81, 94, 111
Tibiakopf-Abstützplatten Großfragment	69
Tibiaplatten Großfragment	68-70
Tiefenanschlag für Verbandsäge Oscillo Compact	281
Tiefenlehre	6
Tiefenmessgerät für Schrauben DHPS	12
Tiefenmessgerät für Schrauben, Großfragment	82
Tiefenmessgerät für Schrauben, Kleinfragment	56
Tiefenmessgerät für Schrauben, Rekonstruktion	96
Tiefenmessgeräte für Schrauben, Minifragment	34
Tiefensägeblatt	279
TIGER Elektrische oszillierende Verbandsäge	274-275

**Alphabetischer Index**

Alphabetical Index

Índice alfabético

Index alphabétique

Índice alfabético

Titan Knochenschrauben für Radiusplatten	43
Titan Y-Radiusplatten	42
T-Platten Großfragment	63, 65
T-Platten Kleinfragment	47
T-Platten Minifragment	14, 17-18, 22
Trephine für Handbohrapparate	285

U

Übersicht Schraubendreher Großfragment	75
Übersicht Schraubendreher Minifragment	26
Übersicht Schraubendreher Kleinfragment	50
UFFENORDE Scharfe Löffel	164
ULRICH Knochenhaltezaugen	196
UNIVERSAL Drahtschere	242
UNIVERSAL Flachzange	237
UNIVERSAL HM Drahtscheren	242
UNIVERSAL Verbandschere	268
Universalbohrbuchse DHPS	11
Universalbohrbuchse Großfragment	79
Universalbohrbuchse Kleinfragment	53
Unterlegscheibe für Malleolarschrauben, Großfragment	74
Unterlegscheibe für Spongiosaschrauben, Großfragment	73
Unterlegscheibe für Spongiosaschrauben, Kleinfragment	49
Unterlegscheiben für kanülierte Schrauben	105, 110, 114
Unterlegscheiben für Kortikalis-schrauben, Minifragment	16, 20, 25
Unterlegscheiben für Spongiosa-schrauben, Rekonstruktion	89, 91, 92

V

VAN BUREN Knochenhaltezaug	180
Verband- und Gipsinstrumente	262-272
Verbandschere	262-268
Verbandsäge oszillierend	274-276, 280-281
Verbindungsschrauben DHPS	8-9
VERBRUGGE-HOHMANN Knochenheber	206
VERBRUGGE Knochenhaltezaug Kleinfragment	60
VERBRUGGE Knochenhaltezaugen	198, 199
VERBRUGGE Knochenhaltezaugen, Großfragment	84
Viertelrohrplatten Minifragment	21
VOLKMANN Scharfe Löffel	167-168, 173
VOLKMANN Wundhaken, Beckeninstrumentarium	101
Vorbohrer für Haken-Marknägel	218

W

WAGNER Hammer	144
WAGNER Raspatorien	135
WARD Raspatorium	125
WEBER Aesthesiometer	211
WEST Flach- und Hohlmeißel	147
WIBERG Raspatorien	126
WILLIGER Elevatorien	121
WILLIGER Hammer	140
WILLIGER KAHRE Raspatorien	125
WILLIGER Raspatorien	124
WILLIGER Scharfe Löffel	165, 171
Winkelmesser	212
WOLFF-BÖHLER Gipsabreißzangen	272
Wundhaken, Beckeninstrumentarium	101

Z

Zangen Drahtextraktion	239-240
Zangen Drahtkneif	243-248
Zangen Drahtspann	236-238
Zangen Flach	37, 58, 236-238
Zangen Knochenhalte	190-199
Zangen Knorpelfass	193-194
Zangen Meniskusfas	193-194
Zangen Nagelextraktion	239-240
Zangen Reposition	191
Zangen Sequester	190
ZAUFAL-JANSEN Hohlmeißelzange	181
Zentrierhülsen DHPS	7-8
Zielgeräte DHPS	5
Zughaken für Kirschner Extensionsbügel	225
Zugschrauben DHPS	4



Alphabetischer Index
Alphabetical Index
 Índice alfabético
 Index alphabétique
 Índice alfabético

A	
Accessories for hand drills	283, 285, 288
ADSON Bone rongeur	177
ADSON Raspatories	127
ALEXANDER Chisels and gouges	150
Amputation	253-260
Amputation knives	254-257
Amputation retractor	260
Amputation saws	258-259
B	
BABY LANGE Bone lever	202
BACON Bone rongeur	178
Bandage and plaster instruments	262-268
Bandage scissors	262-268
BANE Bone rongeur	175
Basic instruments	212
BEEBEE Wire cutting scissors	241
Bending bolt for Kirschner wires, mini fragment	36
Bending bolt for Kirschner wires, small fragment	57
Bending device for bone plates, large fragment	83
Bending lever for plates large fragment	82
Bending levers for plates mini fragment	35
Bending lever for reconstruction plates	96
Bending levers for plates small fragment	57
Bending pliers for Mini plates	36
Bending templates for plates, large fragment	83
Bending templates for plates, small fragment	57
Bending templates for reconstruction plates	97
Bending tool for Ender hooks	215
BENNET Elevator	123
BENNETT Bone levers	207
BERGMANN Bandage scissors	266
BERGMANN (HIBBS) Mallet	141
BEYER Bone rongeurs	177, 181
BIER Amputation saw	259
BIRCHER Bone holding forceps	194
BIRCHER-GANSKE Bone holding forceps	194
BLACK Bone files	118
BLOUNT Bone levers	208
BLOUNT Bone staples	251
BLUMENTHAL Bone rongeurs	175
BÖHLER Traction bows	230
BÖHLER WOLFF Plaster cast breakers	272
Bone cutting forceps	186-189
Bone drill	200

Bone files	118-120
Bone holding clamp	198
Bone holding device, pelvic instrumentation	101
Bone holding forceps	191-199
Bone holding forceps large fragment	84
Bone holding forceps mini fragment	39
Bone holding forceps small fragment	59-60
Bone levers	201-208
Bone levers mini fragment	40
Bone levers small fragment	60
Bone rongeurs	174-185
Bone screws cross slot	43
Bone staples	250-251
Bone suturing wires	231
Bone tampers	148
BRISTOW Raspatory	129
BRÜNNINGS Chisels and gouges	148
BRUNS Bandage scissors	267
BRUNS Sharp curettes	165, 169
BUCK-GRAMCKO Bone lever	201
BUCK Sharp curettes	165
BUNNELL Hand drill	286
Burrs for hand drills	285
C	
Calipers	212
Cannulated screws	104-105, 109-110, 113-114
Cardan wrench for plate tensioner	54, 80
Cartilage forceps	191-199
CASPAR Pestles	149
CATLIN Amputation knives	257
Centering sleeves DHPS	7-8
CHAMPIONNIERE Bone drill	200
CHARRIERE Amputation saw	258
Chisel blades	160
Chisels and gouges	146-161
Chisels and gouges with exchangeable blades	160-161
Cleaning hook	39, 58, 84
CLEVELAND Bone cutting forceps	186
Cloverleaf plates small fragment	47
COBB Gouges	155
COBB Raspatories	133
COHEN Elevator	123
COLLIN Amputation knife	257
COLLIN FARABEUFF Raspatories	128
COLLIN (LUCAE) Mallet	139
Combination wrench for plate tensioner	54, 80
Compass saws for amputation	258
Compression plates large fragment	62

Compression plates mini fragment	14, 17, 21
Compression plates small fragment	46
Compression screw DHPS	4
Condylar buttress plates large fragment	66
Condylar plates mini fragment	15, 19, 24
Cortical screws large fragment	71
Cortical screws mini fragment	16, 20, 25
Cortical screws reconstruction	88, 90
Cortical screws small fragment	48
CORWIN-HEGAR HM Wire twisting forceps	238
COTTLE-KAZANJIAN Bone cutting forceps	186
COTTLE-MEDICON Chisels	147
Countersink small fragment	52
Countersinks cannulated	106, 111, 115
Countersinks large fragment	77-78
Countersinks mini fragment	28
Coupling screws DHPS	8-9
Cross slot screws	43
CUSHING Raspatories	130
D	
DAHMEN Chisels and gouges	157-158
DAUBENSPECK Sharp curettes	164
DEFOURMENTEL Bone rongeur	178
DELIMA HARDT Chisels	145
DEMEL Wire guides	232
DEMEL Wire tightening instrument	234
Depth gauge	6
Depth gauge for plaster saw Oscillo Compact	281
Depth gauge for screws DHPS	12
Depth gauge for screws large fragment	82
Depth gauge for screws reconstruction	96
Depth gauge for screws small fragment	56
Depth gauges for screws mini fragment	34
Depth saw blade	279
DHPS Instrumentation / Set	5-12 / 292
DHPS Plates	2-3
DHPS Screws	4
DINGMAN Bone holding forceps	192
DINGMAN Bone levers	202
Direct measuring device DHPS	6
Disc to limit cut for saw blades	278
Double drill sleeves DHPS	10-11
Double drill sleeves for cannulated screws	107, 112, 116
Double drill sleeves large fragment	78-79
Double drill sleeves mini fragment	29
Double drill sleeves small fragment	53
DOYEN Mallet	139
Drill for titanium screws with cross slot	44



Alphabetischer Index
Alphabetical Index
Índice alfabético
Index alphabétique
Índice alfabético

Drill sleeves DHPS	10-11
Drill sleeves large fragment	78-79
Drill sleeves mini fragment	29
Drill sleeves small fragment	53-54
Drill guides DHPS	5
Drill sleeves for cannulated screws	107, 112, 116
Drills DHPS	10
Drills for cannulated screws	106, 111, 115
Drills large fragment	76
Drills mini fragment	27
Drills reconstruction	93
Drills small fragment	51
E	
EASY CUT HM Wire cutting pliers	246
ECHLIN Bone rongeurs	185
Electric oscillating plaster saws	274-276, 280-281
Elevators	121-123
ENDER Intramedullary hooks	210
ENDER Intramedullary nailing	210-211
ENGEL Plaster saw	271
ESMARCH Bandage scissors	266
ESMARCH Plaster knife	271
EXCENTRIC LISTER Bandage scissors	264
Extracting instrument for Ender hooks	215
Extractor for intramedullary hook-end nails	218
Extractor/impactor for Ender hooks	215
F	
FARABEUFF Bone holding forceps	198
FARABEUFF-COLLIN Raspatories	128
FARABEUFF-LAMBOTTE Bone holding forceps	198
FARABEUFF-LAMBOTTE Pelvic reposition forceps	99
FARABEUFF Raspatories	128
Femur plates large fragment	67
FERGUSSON Bone holding forceps	198
Finger goniometer	212
Fixation discs for wires	228
Flap knife	254
Flat nose pliers	37, 58, 236-238
Flexometer	212
Forceps bone holding	190-199
Forceps cartilage	193-194
Forceps flat nose	37, 58, 236-238
Forceps meniscus	193-194
Forceps nail extracting	239-240
Forceps reposition	191
Forceps sequestum	190

Forceps wire extracting	239-240
Forceps wire twisting	236-238
FREER Chisels	147
FREER Elevators	122
FRIEDMANN Bone rongeur	174
G	
GALLAHER Bone files	118
GANSKE BIRCHER Bone holding forceps	194
GEIGER Bone rongeur	180
GERZOG Mallet	140
GOLIATH HM Wire cutting pliers	247
Goniometer	212
Gouge blades	161
Gouges	146-156, 158-161
GRAMCKO BUCK Bone lever	201
Grasping forceps	193-194
Guide shaft DHPS	9
Guide wire DHPS	6
H	
H-Plate mini fragment	14
HAJEK Mallet	139
HALLE Sharp curettes	170
Hand drills	283-289
Handles with quick coupling	30, 106
HARDT-DELIMA Chisels	145
HARMS HM Wire cutting pliers	247
HARTMANN Bone rongeur	176
HARVEY Wire cutting scissors	242
HEGAR CORWIN HM Wire twisting forceps	238
HEMINGWAY Sharp curettes	172
HENAHAN Elevators	121
HENNIG Plaster spreader	272
HERNANDEZ-ROS Staple driver	250
HERNANDEZ-ROS Staple extractor	250
HERNANDEZ-ROS Staple holder	250
HIBBS BERGMANN Mallet	141
HIBBS Chisels and gouges	152
HM Plate and wire cutting forceps	37, 58
HM Wire cutting pliers	243-248
HM Wire cutting scissors	241-243
HM Wire twisting forceps	236, 238
HOEN Elevators	121
HOHMANN Bone levers	205
HOHMANN LANGE Bone levers	203
HOHMANN LANGE MODIF. Bone levers	204
HOHMANN VERBRUGGE Bone levers	206
Holding forceps for plates mini fragment	38
Holding sleeve for screws DHPS	12
Holding sleeve for screws large fragment	82

Holding sleeves for screws mini fragment	32-33
Holding sleeves for cannulated screws	108, 112, 116
Holding sleeves for screws small fragment	56
Holding sleeves for screws reconstruction	95
HOPKINS Plaster knife	271
I	
Impactor and extractor for intramedullary hook-end nails	218
Impactor DHPS	9
Impactor for Ender hooks	214
Impactor/extractor for Ender hooks	215
Impactors for bone staples	78
Insert drill sleeve large fragment	78
Insert drill sleeve small fragment	53
Inserting instrument for Ender hooks	214
Instrumentation DHPS	5-12
Instrumentation for cannulated screws	106-108, 111-112, 115-116
Instrumentation for clip suturing	249-251
Instruments for bone staples	250-251
Instrumentation mini fragment	26-40
Intramedullary hook-end nails	216-218
Intramedullary nailing	214-218
J	
JAMESON Caliper	212
JANSEN Bone rongeurs	177, 178
JANSEN Sharp curettes	171, 172
JANSEN ZAUFAL Bone rongeur	181
JOSEPH Bone files	118
JOSEPH Raspatory	125
K	
KAHRE-WILLIGER Raspatories	125
KAZANJIAN COTTLE Bone cutting forceps	186
KERN Bone holding forceps	195
KERPEL Sharp curettes	163
KEY LISTON Bone cutting forceps	189
KEY Raspatories	129
KIRK Mallet	141
KIRMISSION Raspatory	128
KIRSCHNER MOD. USA Traction bows	225
KIRSCHNER Traction bows	226-228
KIRSCHNER Wire containers	224
KIRSCHNER Wires	220-221
KISTLER-MANUS Bone holding forceps	191



Alphabetischer Index
Alphabetical Index
 Índice alfabético
 Index alphabétique
 Índice alfabético

KLEINERT-KUTZ Bone rongeurs	177, 179
Knives amputation	254-257
Knives resection	254-255
KNOWLES Bandage scissors	262
KOENIG Raspatory	124
KRÄMER Raspatories	126
KUTZ KLEINERT Bone rongeurs	177, 179

L

L-Buttress plates large fragment	64
L-Plates mini fragment	18-19, 22-23
LAMBOTTE Bone lever	202
LAMBOTTE Chisels	162
LAMBOTTE FARABEUF Bone holding forceps	198
LAMBOTTE FARABEUF Pelvic reposition forceps	99
LAMBOTTE MINI Chisels	145
LAMBOTTE Raspatories	129
LANE Bone holding forceps	197
LANE Bone lever	202
LANE MURPHY Bone lever	207
LANGE-BABY Bone lever	202
LANGE Bandage scissors	263
LANGE Bone lever	203
LANGE-HOHMANN Bone levers	203
LANGE-HOHMANN MODIF. Bone levers	204
LANGENBECK Bone holding forceps	197
LANGENBECK Compass saw for amputation	258
LANGENBECK Elevators	122
LANGENBECK Flap knife	254
LANGENBECK Raspatories	130
LANGENBECK Resection knives	254, 255
Large fragment / Set	61-84 / 298-300
Large fragment instrumentation	76-84
Large fragment plates	62-70
Large fragment screws	71-74
LEKSELL Bone rongeurs	184-185
LEMPERT Bone rongeurs	179
LEMPERT Raspatories	126
LEMPERT Sharp curettes	170
LEWIN Bone holding forceps	191
LEXER Chisels and gouges	153
LEXER Gouges	156
LEXER MINI Chisels and gouges	153
LISTER Bandage scissors	264-265
LISTER-EXCENTRIC Bandage scissors	264
LISTON Amputation knife	255
LISTON Bone cutting forceps	187
LISTON-KEY Bone cutting forceps	189

LISTON-LITTAUER Bone cutting forceps	186
LISTON-MINI Bone cutting forceps	187
LISTON Phalangeal knife	254
LISTON RUSKIN Bone cutting forceps	188
LISTON-STILLE Bone cutting forceps	189
LITTAUER-LISTON Bone cutting forceps	186
LORENZ Bandage scissors	263
LOUTE Wire tightening instrument	234
LOWMAN Bone holding clamp	198
LOWMAN Bone holding forceps	198
LUCAE COLLIN Mallet	139
LUER Bone rongeurs	175-176
LUER STILLE Bone rongeurs	182

M

MACDONALD Elevator	123
Malleolar screws large fragment	74
Mallets	139-144
MANUS KISTLER Bone holding forceps	191
MARQUARDT Bone rongeur	182
MARTIN Bone holding forceps	193
MARTINI Sharp curettes	171
MCINDOE Bone cutting forceps	188
MCKENTY Raspatories	125
MEAD Bone rongeurs	174
MEAD Mallet	140
MEAD Raspatory	124
Measuring device DHPS	6
Measuring instruments	211-212
MEDICON Bandage scissors	268
MEDICON COOTLE Chisels	147
MEDICON HM Wire twisting forceps	236
MEDICON Wire twisting forceps	236
Meniscus forceps	193-194
MEYHOEFER Sharp curettes	163
MILLER Bone files	119
MINI-LAMBOTTE Chisels	145
MINI-LEXER Chisels and gouges	153
MINI LISTON Bone cutting forceps	187
MINI RUSKIN Bone rongeurs	179
MINI STILLE Plaster shears	269
Mini fragment / Set	13-40 / 293-295
Mini fragment instrumentation	26-40
Mini fragment plates	14-15, 17-19, 21-24
Mini fragment screws	16, 20, 25
MOD. USA Plaster spreader	272
MÖLTGEN Flexometer	212
MOLT Raspatories	124
MOORE Hand drill	283
Motor systems and hand drills	274-289

Multifragment plate mini fragments	23
MURPHY-LANE Bone lever	207

N

Nail extracting forceps	239-240
NIRO Bone cutting forceps	186
NIRO HM Wire twisting forceps	236
NIRO Wire twisting forceps	236

O

OLIVECRONA Bone rongeur	176
OLIVECRONA Raspatory	127
OMBREDANNE Mallet	142
One third plates small fragment	46
OSCI-CLEAN Vacuum cleaner for plaster saw Oscillo Compact	282
OSCILLO COMPACT Electric oscillating plaster saw	280-281
OSCILLO V Electric oscillating plaster saw	276
Osteotome blades	161
Overview screwdrivers large fragment	75
Overview screwdrivers mini fragment	26
Overview screwdrivers small fragment	50

P

Parallel drill sleeve mini fragment	29
Parallel drill sleeve small fragment	54
PARTSCH Chisels and gouges	146
PASSOW Bone tampers	148
Pelvic instrumentation	93-102
Pelvic reposition forceps	98-100
Pelvis lever	102
PERCY Amputation retractor	260
PERTHES Reamers	200
PETERSEN SMITH Bone rongeurs	180
PETERSEN SMITH Chisels and gouges	159
Phalangeal knife	254
Plaster and bandage instruments	262-272
Plaster cast breakers	272
Plaster knives	271
Plaster saw	271
Plaster shears	269-270
Plaster spreaders	272
Plastic case for plaster saw Oscillo Compact	281
Plate and wire cutting forceps HM	37, 58
Plate bending pliers for reconstruction plates	96
Plate tensioner	54, 80
Plates DHPS	2-3
Plates large fragment	62-70
Plates mini fragment	14-15, 17-19, 21-24



Alphabetischer Index
Alphabetical Index
Índice alfabético
Index alphabétique
Índice alfabético

Plates reconstruction	86-87
Plates small fragment	48-49
Plates supra condilar	3
PUTTI Bone files	118
Q	
Quarter tubular plates mini fragments	21
R	
Radius plates	42
RALK Hand drill	288
Raspatories	124-138
Raspatory mini fragment	39
Raspatory small fragment	59
Reamers	200
Reamers three steps	6
Reconstruction	85-92
Reconstruction plates	86-87
Reconstruction screws	88-92
REINER Plaster knife	271
Reposition forceps	191
Reposition forceps mini fragment	38
Reposition forceps, pelvic instrumentation	98
Resection knives	254-255
Retractor, pelvic instrumentation	101
ROS HERNANDEZ Staple driver	250
ROS HERNANDEZ Staple extractor	250
ROS HERNANDEZ Staple holder	250
ROWLAND RUSKIN Bone cutting forceps	188
Rulers stainless steel	211
RUSKIN Bone rongeurs	180, 181
RUSKIN-LISTON Bone cutting forceps	188
RUSKIN-MINI Bone rongeurs	179
RUSKIN-ROWLAND Bone cutting forceps	188
RUST Amputation saw	259
S	
SATTERLEE Amputation saw	258
Saw blades for electric oscillating plaster saws	274, 276, 278-279, 281
SCHANZ Screws	102, 224
SCHEDE Sharp curettes	167
SCHELL Bone rongeur	175
SCHUKNECHT Wire cutting scissors	242
Screw holding forceps	12, 56, 36, 112
Screws cannulated	104-105, 109-110, 113-114
Screws DHPS	4
Screws for radius plates	43
Screws large fragment	71-74
Screws mini fragment	16, 20, 25
Screws reconstruction	88-92

Screws small fragment	48-49
Screwdriver	209-210
Screwdriver blade for cross slot	44
Screwdriver cross slot	44
Screwdriver DHPS	11
Screwdriver handles	44, 204
Screwdriver handles mini fragment	30
Screwdriver hexagonal	11, 209-210
Screwdriver inserts	209
Screwdriver inserts large fragment	81
Screwdriver inserts mini fragment	31
Screwdriver inserts small fragment	55
Screwdriver set	209
Screwdrivers cannulated	107, 112, 116
Screwdrivers large fragment	81-82
Screwdrivers mini fragment	30-32
Screwdrivers reconstruction	94-95
Screwdrivers small fragment	55
Scissors bandage	262-268
SEBILAU Elevator	121
SEDILLOT Raspatories	127
Segmental saw blade	279
SEMB Bone holding forceps	195
SEMB Raspatories	138
SEMB-STILLE Bone rongeurs	183
Semi tubular plates large fragment	63
Sequestrum forceps	190
Service set for vacuum cleaner	277
SEUTIN Bandage scissors	268
Sharp curettes	163-173
SHEEHAN Chisels and gouges	146
SHERMAN STILLE Hand drill	284
SIEBENMANN Sharp curettes	164
Small fragment / Set	45-60 / 296-297
Small fragment instrumentation	51-60
Small fragment plates	46-47
Small fragment screws	48-49
SMEDBERG Hand drill	289
SMITH Bandage scissors	262
SMITH-PETERSEN Bone rongeurs	180
SMITH-PETERSEN Chisels and gouges	159
Spare blades for amputation saws	258-259
Spare blades for plaster shears	269-270
Spare paper bag for vacuum cleaner Osci-Clean	282
Spongiosa screws large fragment	72-73
Spongiosa screws reconstruction	89, 91-92
Spongiosa screws small fragment	49
Spoon plates large fragment	65
SPRATT Sharp curettes	170
Spring clamp for wrench	229

Screw holding forceps mini fragment	36
Staple driver	250
Staple extractor	250
Staple holder	250
STEINMANN Nails	222-224
STELLBRINK Bone rongeurs	178
STILLE Bone rongeur	183
STILLE Chisels and gouges	151
STILLE Hand drill	284
STILLE LISTON Bone cutting forceps	189
STILLE-LUER Bone rongeurs	182
STILLE-MINI Plaster shears	269
STILLE Plaster shears	269-270
STILLE SEMB Bone rongeurs	183
STILLE-SHERMAN Hand drill	284
Support plate for reposition forceps	101
Supra condilar plates	3
T	
T-Buttress plates large fragment	65
T-Plates large fragment	63, 65
T-Plates mini fragment	14, 17-18, 22
T-Plates small fragment	47
Taps DHPS	7, 10
Tape measures	211
Taps for cortical screws, reconstruction	93
Taps for intramedullary hook-end nails	218
Taps large fragment	76-77
Taps mini fragment	27
Taps small fragment	51-52
T-Handle with quick coupling	7, 11, 55, 81, 94, 111
Three-step reamers for DHPS plates	6
Tibial head buttress plates large fragment	69
Tibial plates large fragment	68-70
TIGER Electric oscillating plaster saw	274-275
Tightening wrenches for hand drills	286-289
Titanium bone screws for radius plates	43
Titanium radius plates Y-shaped	42
Traction bows	225-230
Traction hook for Kirschner traction bows	225
Traction screws DHPS	4
Trephine for hand drills	285
Twist drills for hand drills	283, 285, 288
U	
UFFENORDE Sharp curettes	164
ULRICH Bone holding forceps	196
UNIVERSAL Bandage scissors	268
Universal drill sleeve DHPS	11
Universal drill sleeve large fragment	79



Alphabetischer Index
Alphabetical Index
 Índice alfabético
 Index alphabétique
 Índice alfabético

Universal drill sleeve small fragment	53
UNIVERSAL Flat nose pliers	237
UNIVERSAL HM Wire cutting scissors	242
UNIVERSAL Wire cutting scissors	242

V

Vacuum cleaners for plaster saws	277, 282
VAN BUREN Bone holding forceps	190
VERBRUGGE Bone holding forceps	198, 199
VERBRUGGE Bone holding forceps small fragment	60
VERBRUGGE Bone holding forceps large fragment	84
VERBRUGGE-HOHMANN Bone levers	206
VOLKMANN Retractor, pelvic instrumentation	101
VOLKMANN Sharp curettes	167-168, 173

W

WAGNER Mallet	144
WAGNER Raspatories	135
WARD Raspatory	125
Washer for malleolar screws, large fragment	74
Washer for spongiosa screws, large fragment	73
Washer for spongiosa screws, small fragment	49
Washers for cannulated screws	105, 110, 114
Washers for cortical screws, mini fragment	16, 20, 25
Washers for spongiosa screws, reconstruction	89, 91, 92
WEBER Aesthesiometer	211
WEST Chisels and gouges	147
WIBERG Raspatories	126
WILLIGER Elevators	121
WILLIGER KAHRE Raspatories	125
WILLIGER Mallet	140
WILLIGER Raspatories	124
WILLIGER Sharp curettes	165, 171
Wire and plate cutting forceps HM	37, 58
Wire and wire instruments	220-248
Wire containers	224
Wire cutting pliers	243-248
Wire cutting pliers HM	243-247
Wire cutting scissors	241-243
Wire cutting scissors HM	242-243
Wire extracting forceps	239-240
Wire guides	232-233
Wire pin cutting pliers	248

Wire tightening instruments	234-235
Wire twisting forceps	236-238
Wire twisting forceps HM	236-238
WOLFF-BOEHLER Plaster cast breakers	272
Wrench for DHPS screws	8
Wrench for Kirschner traction bows	226, 229
Wrench for plate tensioner	54
Wrenches for electric oscillating plaster saws	274, 276, 279

Z

ZAUFAL-JANSEN Bone rongeur	181
----------------------------	-----



Alphabetischer Index
Alphabetical Index
Indice alfabético
Index alphabétique
Indice alfabetico

A	
ADSON Legras	127
ADSON Pinza gubia	177
Agujas conductoras de alambre	292-293
Alambre e instrumentos para alambre	220-248
Alambre para huesos	231
ALEXANDER Cinceles y gubias	150
Alicate corta alambre y clavos	248
Alicate plano para mini fragmentos	37
Alicate plano para pequeños fragmentos	58
Alicates planos	236-238
Amputación	253-260
Aparatos de puntería DHPS	5
Arandela para tornillos esponjosos para fragmentos grandes	73
Arandela para tornillos esponjosos para pequeños fragmentos	49
Arandela para tornillos para maléolo para fragmentos grandes	74
Arandelas para tornillos canulados	105, 110, 114
Arandelas para tornillos corticales para mini fragmentos	16, 20, 25
Arandelas para tornillos esponjosos de reconstrucción	89, 91, 92
Aspiradores para sierras de yeso	277, 282
Atornillador con cabeza en cruz	44
Atornillador, DHPS	11
Atornilladores	209-210
Atornilladores canulados	107, 112, 116
Atornilladores hexagonal	11, 209-210
Atornilladores para fragmentos grandes	81-82
Atornilladores para mini fragmentos	30-32
Atornilladores para pelvis/reconstrucción	94-95
Atornilladores para pequeños fragmentos	55
B	
BABY LANGE Elevador para hueso	202
BACON Pinza gubia	178
BANE Pinza gubia	175
Barra para sujetar huesos, instrumental para pelvis	101
BEEBEE Tijeras para cortar alambre	241
BENNET Elevador	123
BENNETT Elevadores para hueso	207
BERGMANN (HIBBS) Martillo	141
BERGMANN Tijera para vendajes	266
BEYER Pinzas gubias	177, 181
BIER Sierra de amputación	259
BIRCHER-GANSKE Pinza prensora de huesos	194
BIRCHER Pinza prensora de huesos	194

BLACK Limas para huesos	118
BLOUNT Elevadores para hueso	208
BLOUNT Grapas para huesos	251
BLUMENTHAL Pinzas gubias	175
BÖHLER Estribos de extensión	230
BÖHLER WOLFF Pinzas para arrancar vendajes	272
BRISTOW Legra	129
Broca para tornillos en titanio con cabeza en cruz	44
Brocas de tres escalones DHPS	6
Brocas DHPS	10
Brocas espirales para perforadores de mano	283, 285, 288
Brocas para mini fragmentos	27
Brocas para pelvis	93
Brocas para pequeños fragmentos	51
Brocas para fragmentos grandes	76
Brocas para tornillos canulados	106, 111, 115
BRÜNINGS Cinceles y gubias	148
BRUNS Cucharillas cortantes	165, 169
BRUNS Tijeras para vendajes	267
BUCK Cucharillas cortantes	165
BUCK-GRAMCKO Elevador para huesos	201
BUNNELL Perforador de mano	286
C	
Calibradores	212
Calibre de profundidad	6
CASPAR Pisón	149
Casquillos de inserción para fragmentos pequeños	53
Casquillos de taladrar doble, DHPS	10-11
Casquillo de taladrar universal, DHPS	11
Casquillos de taladrar para fragmentos grandes	78-79
Casquillos de taladrar para mini fragmentos	29
Casquillos de taladrar para pequeños fragmentos	53-54
Casquillos de taladrar para tornillos canulados	107, 112, 116
CATLIN Cuchillos para amputación	257
CHAMPIONNIERE Taladro para huesos	200
CHARRIERE Sierra de amputación	258
Cinceles y gubias	146-161
Cinceles y gubias con hojas intercambiables	140-161
Cintas métricas	211
Cizallas para vendajes	268-270
Clavos intramedulares con gancho	216-218

Clavos medulares	214-218
CLEVELAND Pinza cortante para huesos	186
COBB Gubias	155
COBB Legras	133
COHEN Elevador	123
COLLIN Cuchillo para amputación	257
COLLIN FARABEUF Legras	128
COLLIN (LUCAE) Martillo	139
Contenedores para brocas	224
CORWIN-HEGAR HM Pinzas tensoras de alambre	238
COTTLE-KAZANJIAN Pinza cortante para huesos	186
COTTLE-MEDICON Cinceles	147
Cucharillas cortantes	163-173
Cuchillo para falanges	254
Cuchillo para lobulos	254
Cuchillos para amputación	254-257
Cuchillos para resección	255
Cuchillos para yeso	271
CUSHING Legras	130
D	
DAHMEN Cinceles y gubias	157-158
DAUBENSPECK Cucharillas cortantes	164
DEFORMENTEL Pinza gubia	178
DELIMA HARDT Cinceles	145
DEMEL Agujas conductoras de alambre	232
DEMEL Tensor de alambre	234
DHPS Instrumental / DHPS juego	5-12 / 292
DHPS Placas	2-3
DHPS Tornillos	4
DINGMAN Elevadores para hueso	202
DINGMAN Pinzas prensoras de huesos	192
Disco para limitar la profundidad para hojas de sierra	278
Discos de fijación para brocas	228
DOYEN Martillo	139
E	
EASY CUT HM Pinca para cortar alambre	246
ECHLIN Pinzas gubias	185
Elevadores	121-123
Elevadores para huesos	201-208
Elevadores para huesos, mini fragmentos	40
Elevadores para huesos, fragmentos pequeños	60
ENDER Clavos medulares	214-215
ENGEL Sierra para yeso	271
Escariadores	200
ESMARCH Cuchillo para yeso	271



Alphabetischer Index
 Alphabetical Index
 Indice alfabético
 Index alphabétique
 Indice alfabetico

ESMARCH Tijeras para vendajes	266
Estribos de extensión	225-230
EXCENTRIC LISTER Tijeras para vendajes	264
Extensor de placa para fragmentos grandes	80
Extensor de placa para pequeños fragmentos	54
Extractor de grapas	250
Extractor para clavos medulares con gancho	218
Extractor/impactor para clavos Ender	215
F	
FARABEU-F-COLLIN Legras	128
FARABEU Legras	128
FARABEU-LAMBOTTE Pinza para reposicionar pelvis	99
FARABEU-LAMBOTTE Pinza prensora de huesos	198
FARABEU Pinzas prensoras de huesos	198
FERGUSSON Pinza prensora de huesos	198
Fragmentos grandes y juego	298-300
FREER Cinceles	147
FREER Elevadores	122
Fresa para pequeños fragmentos	52
Fresas para tornillos canuladas	106, 111, 115
Fresas para fragmentos grandes	77-78
Fresas para mini fragmentos	28
Fresas para perforadores de mano	289
FRIEDMANN Pinza gubia	174
G	
GALLAHER Limas para huesos	118
Gancho de tracción para Kirschner estribos de extensión	225
Gancho para limpieza	39, 58, 84
Ganchos de extracción para clavos intramedulares	219
GANSKE BIRCHER Pinza prensora de huesos	194
GEIGER Pinza gubia	180
GERZOG Martillo	140
GOLIATH HM Pinca para cortar alambre	247
Goniómetro para dedos	212
GRAMCKO BUCK Elevador para huesos	201
Grapas para huesos	198, 250-251
Gubias	146-156, 158-161
Guía, medular	215
H	
HAJEK Martillo	139
HALLE Cucharillas cortantes	170

HARDT-DELIMA Cinceles	145
HARMS HM Pinca para cortar alambre	247
HARTMANN Pinza gubia	176
HARVEY Tijera para cortar alambre	242
HEGAR CORWIN HM Pinzas tensoras de alambre	238
HEMINGWAY Cucharillas cortantes	172
HENAHAN Elevadores	121
HENNIG Pinza para abrir vendajes	272
HERNANDEZ-ROS Extractor de grapas	250
HERNANDEZ-ROS Impactor de grapas	250
HERNANDEZ-ROS Porta-grapas	250
HIBBS BERGMANN Martillo	141
HIBBS Cinceles y gubias	152
Hilo conductor DHPS	6
HM Pinza para cortar placas y alambre	37, 58
HM Pinzas para cortar alambre	243-248
HM Pinzas tensoras de alambre	242, 244
HM Tijeras para cortar alambre	241-243
HOEN Elevadores	121
HOHMANN Elevadores para hueso	205
HOHMANN LANGE Elevadores para hueso	203
HOHMANN LANGE MODIF. Elevadores para hueso	204
HOHMANN VERBRUGGE Elevadores para hueso	206
Hoja de atornillador para tornillos con cabeza en cruz	44
Hoja de sierra de profundidad	279
Hoja de sierra de segmento	279
Hojas de cincel	161
Hojas de gubia	162
Hojas de osteótomo	162
Hojas de repuesto para cizallas para vendajes	269-270
Hojas de repuesto para sierras de amputación	258-259
Hojas para sierras eléctricas oscilante para vendajes	274, 276, 278-279, 281
HOPKINS Cuchillo para yeso	271
I	
Impactor de grapas	250
Impactor, DHPS	9
Impactor para insertar clavo Ender	214
Impactor y extractor para clavos medulares con gancho	218
Impactor/extractor para clavos Ender	215
Impactores para grapas para huesos	251
Insertos para atornilladores	209

Insertos para atornilladores para fragmentos grandes	81
Insertos para atornilladores para mini fragmentos	31
Insertos para atornilladores para pequeños fragmentos	55
Insertos para perforadores de mano	283, 285, 288
Instrumental DHPS / juego DHPS	5-12 / 292
Instrumental para fragmentos grandes / y juego	76-84 / 298-300
Instrumental para grapas	249-251
Instrumental para mini fragmentos y juego	26-40 / 293-295
Instrumental para pequeños fragmentos y juego	51-80 / 296-297
Instrumental para tornillos canulados	106-108, 111-112, 115-116
Instrumento para extracción	215
Instrumento para insertar clavos de Ender	214
Instrumento para medir, DHPS	6
Instrumento para medir la profundidad para fragmentos grandes	82
Instrumentos para medir la profundidad para mini fragmentos	34
Instrumento para medir la profundidad para pequeños fragmentos	56
Instrumento para medir la profundidad para reconstrucción	96
Instrumentos básicos	212
Instrumentos de medida	211-212
Instrumentos para grapas para huesos	250-251
Instrumentos para yeso y vendajes	262-272
Instrumentos tensores de alambre	234-235
Instrumental para pelvis	93-102
Instrumentos para vendajes y yeso	262-272
J	
JAMESON Calibrador	210
JANSEN Cucharillas cortantes	171, 172
JANSEN Pinzas gubias	177, 178
JANSEN ZAUFAL Pinza gubia	181
JOSEPH Legra	125
JOSEPH Limas para huesos	118
Juego de atornillador	209
K	
KAHRE-WILLIGER Legras	125
KAZANJIAN COTTLE Pinza cortante para huesos	186
KERN Pinzas prensoras de huesos	195



Alphabetischer Index
 Alphabetical Index
 Índice alfabético
 Index alphabétique
 Índice alfabético

KERPEL Cucharillas cortantes	163
KEY Legras	129
KEY LISTON Pinza cortante para huesos	189
KIRK Martillo	141
KIRMISSION Legra	128
KIRSCHNER Brocas	220-221
KIRSCHNER Contenedores para brocas	224
KIRSCHNER Estribos de extensión	226-228
KIRSCHNER MOD. USA Estribos de extensión	225
KISTLER-MANUS Pinza prensora de huesos	191
KLEINERT-KUTZ Pinzas gubias	177, 179
KNOWLES Tijeras para vendajes	262
KOENIG Legra	124
KRAEMER Legras	126
KUTZ KLEINERT Pinzas gubias	177, 179
L	
LAMBOTTE Cinceles	162
LAMBOTTE Elevador para huesos	202
LAMBOTTE FARABEUZ Pinza para reposicionar pelvis	99
LAMBOTTE FARABEUZ Pinza prensora de huesos	198
LAMBOTTE Legras	129
LAMBOTTE MINI Cinceles	145
LANE Elevador para huesos	202
LANE MURPHY Elevador para hueso	207
LANE Pinzas prensoras de huesos	197
LANGE Elevador para hueso	203
LANGE Tijera para vendajes	263
LANGE-BABY Elevador para hueso	202
LANGE-HOHMANN Elevadores para hueso	203
LANGE-HOHMANN MODIF. Elevadores para hueso	204
LANGENBECK Cuchillo para lobulos	254
LANGENBECK Cuchillos para resección	254
LANGENBECK Elevadores	122
LANGENBECK Legras	130
LANGENBECK Pinza prensora de huesos	197
LANGENBECK Sierra de calar para amputación	258
Legras	124-138
Legra para mini fragmentos	39
Legra para pequeños fragmentos	59
LEKSELL Pinzas gubias	184-185
LEMPERT Cucharillas cortantes	170
LEMPERT Legras	126
LEMPERT Pinzas gubias	179

LEWIN Pinza prensora de huesos y para reposición	191
LEXER Cinceles y gubias	154
LEXER Gubias	156
LEXER MINI Cinceles y gubias	153
Limas para huesos	118-120
LISTER Tijeras para vendajes	263-265
LISTER-EXCENTRIC Tijeras para vendajes	264
LISTON Cuchillo para amputación	255
LISTON Cuchillo para falanges	254
LISTON LITTAUER Pinza cortante para huesos	186
LISTON-KEY Pinza cortante para huesos	189
LISTON-MINI Pinzas cortantes para huesos	187
LISTON Pinzas cortantes para huesos	187
LISTON RUSKIN Pinzas cortantes para huesos	188
LISTON-STILLE Pinzas cortantes para huesos	189
LITTAUER Pinza cortante para huesos	186
Llave bifurcada/anular para extensor de placa	54, 80
Llave cardan para extensor de placa	54, 80
Llave con mango en T para tornillos DHPS	8
Llave para estribos de extensión Kirschner	226, 229
Llaves para sierras eléctricas oscilante para vendajes	274, 276, 279
Llaves tensoras perforadores de mano	286-289
LORENZ Tijera para vendajes	263
LOUTE Tensor de alambre	234
LOWMAN Grapa-parta huesos	198
LOWMAN Pinzas prensoras de huesos	198
LUCAE COLLIN Martillo	139
LUER Pinzas gubias	175-176
LUER STILLE Pinzas gubias	182
M	
MACDONALD Elevador	123
Maletin en plástico para sierra para vendajes Oscillo Compact	281
Mangos con acoplamiento rápido	30, 106
Mangos de atornilladores	44
Mango en T con acoplamiento rápido	7, 110 55, 81, 94, 111
Mango para atornillador	209
Mangos de atornilladores para mini fragmentos	30
Manija para sujetar	229

MANUS KISTLER Pinza prensora de huesos	191
MARQUARDT Pinza gubia	182
Martillos	139-144
MARTIN Pinzas prensoras de huesos	193
MARTINI Cucharillas cortantes	171
MCINDOE Pinzas cortantes para huesos	188
MCKENTY Legras	125
MEAD Legra	124
MEAD Martillo	140
MEAD Pinzas gubias	174
MEDICON COTTLE Cinceles	147
MEDICON HM Pinza tensora de alambre	236
MEDICON Pinza tensora de alambre	236
MEDICON Tijera para vendajes	268
Medidor de profundidad para tornillos DHPS	12
Medidor de profundidad para tornillos para fragmentos grandes	82
Medidor de profundidad para tornillos para pelvis/reconstrucción	96
Medidor de profundidad para tornillos para pequeños fragmentos	56
Medidores de profundidad para tornillos para mini fragmentos	34
MEYHOEFER Cucharillas cortantes	163
MILLER Limas para huesos	119
Mini fragmentos y juego	13-40 / 293-295
MINI-LAMBOTTE Cinceles	145
MINI-LEXER Cinceles y gubias	153
MINI LISTON Pinzas cortantes para huesos	187
MINI RUSKIN Pinzas gubias	179
MINI STILLE Cizalla para vendajes	269
MOD. USA Pinza para abrir vendajes	272
MÖLTGEN Goniómetro	212
MOLT Legras	124
MOORE Perforador de mano	283
MURPHY-LANE Elevador para hueso	207
N	
NIRO HM Pinza tensora de alambre	236
NIRO Pinza cortante para huesos	186
NIRO Pinzas tensoras de alambre	236
O	
OLIVECRONA Legra	127
OLIVECRONA Pinza gubia	176
OMBREDANNE Martillo	142
OSCI-CLEAN Aspirador para sierra de yeso Oscillo Compact	282



Alphabetischer Index
 Alphabetical Index
 Índice alfabético
 Index alphabétique
 Indice alfabetico

OSCILLO COMPACT Sierra eléctricas oscilante para vendajes	280-281
OSCILLO V Sierra eléctricas oscilante para vendajes	276
P	
Palanca para doblar placas de reconstrucción	96
Palanca para doblar placas para fragmentos grandes	82
Palanca para pelvis	102
Palanca para doblar clavos Ender	215
Palancas para doblar placas para mini fragmentos	35
Palancas para doblar placas para pequeños fragmentos	57
PARTSCH Cinceles y gubias	146
PASSOW Cinceles tamponadores para huesos	148
Pequeños fragmentos	45-60
PERCY Retractor de amputación	260
Perforador para clavos medulares con gancho	218
Perforadoras de mano	291
Perforadores de mano	283-289
Perno para doblar brocas de Kirschner para mini fragmentos	36
Perno para doblar brocas de Kirschner para pequeños fragmentos	57
PERTHES Escariadores	200
PETERSEN SMITH Cinceles y gubias	159
PETERSEN SMITH Pinzas gubias	180
Pinza HM para cortar placas y alambre	37, 58
Pinza para doblar para mini placas	36
Pinza para doblar placas de reconstrucción	96
Pinza para huesos para mini fragmentos	39
Pinza para reposición de pelvis	98-100
Pinza para reposición para mini fragmentos	38
Pinzas para reposición, instrumental para pelvis	98-100
Pinzas prensoras de huesos	191-199
Pinzas cortantes para huesos	186-189
Pinzas gubias	174-185
Pinzas para abrir vendajes	272
Pinzas para agarrar placas para mini fragmentos	38
Pinza para agarrar tornillos	12, 36, 56, 108, 112
Pinzas para arrancar vendajes	272
Pinzas para cartilagos	193-194

Pinzas para cortar alambre	243-248
Pinzas para cortar alambre, HM	243-247
Pinzas para extraer alambres	239-240
Pinzas para extraer clavos	239-240
Pinzas para huesos para fragmentos grandes	83
Pinzas para huesos para pequeños fragmentos	59-60
Pinzas para meniscos	193-194
Pinzas para reposición	191
Pinzas para secuestrectomia	190
Pinzas prensoras de huesos	190-199
Pinzas tensoras de alambre	236-238
Pinzas tensoras de alambre, HM	236-238
Pisón para huesos	148
Placa de apoyo para pinzas de reposición	101
Placa en forma de H para mini fragmentos	14
Placa multi fragmentos para mini fragmentos	23
Placas 1/2 tubo para fragmentos grandes	63
Placas 1/3 tubo para pequeños fragmentos	46
Placas 1/4 tubo para mini fragmentos	21
Placas condilares para apoyar fragmentos grandes	66
Placas condilares para mini fragmentos	15, 19, 24
Placas de compresión para fragmentos grandes	62
Placas de compresión para mini fragmentos	14, 17, 21
Placas de compresión para pequeños fragmentos	46
Placas de premoldeación para fragmentos grandes	83
Placas de premoldeación para pequeños fragmentos	57
Placas de premoldeación para placas de reconstrucción	97
Placas de reconstrucción	86, 87
Placas DHPS	2-3
Placas distales para femur para fragmentos grandes	63, 65
Placas en forma de cuchara para fragmentos grandes	65
Placas en forma de L para mini fragmentos	18-19, 22-23
Placas en forma de T para fragmentos grandes	67
Placas en forma de T para mini fragmentos	14, 17-18, 22
Placas en forma de T para pequeños fragmentos	47

Placas en forma de trébol para pequeños fragmentos	47
Placas para apoyar en form de L para fragmentos grandes	64
Placas para apoyar en form de T para fragmentos grandes	65
Placas para apoyar la cabeza de tibia para fragmentos grandes	69
Placas para fragmentos grandes	62-70
Placas para mini fragmentos	14-15, 17-19, 21-24
Placas para pequeños fragmentos	46-47
Placas para tibia para fragmentos grandes	68-70
Placas radiales en forma de Y, titanio	42
Placas supra condilares	3
Porta-grapas	250
Prensa para placas de hueso para fragmentos grandes	83
PUTTI Limas para huesos	118
R	
RALK Perforador de mano	288
Reconstrucción	85-92
Reglas de acero inoxidable	211
REINER Cuchillo para yeso	271
Retractor de amputación	260
ROS HERNANDEZ Extractor de grapas	250
ROS HERNANDEZ Impactor de grapas	250
ROS HERNANDEZ Porta-grapas	250
Roscadores para mini fragmentos	27
Roscadores para fragmentos grandes	76-77
Roscadores para pequeños fragmentos	51-52
Roscadores para tornillos corticales para pelvis	93
Roscadores, DHPS	7, 10
ROWLAND RUSKIN Pinzas cortantes para huesos	188
RUSKIN-LISTON Pinzas cortantes para huesos	188
RUSKIN-MINI Pinzas gubias	179
RUSKIN Pinzas gubias	180, 181
RUSKIN-ROWLAND Pinzas cortantes para huesos	188
RUST Sierra de amputación	259
S	
Saco de papel de repuesto para aspirador Osci-Clean	282
SATTERLEE Sierra de amputación	258
SCHANZ Tornillos	102, 224
SCHEDE Cucharillas cortantes	167
SHELL Pinza gubia	175



Alphabetischer Index
Alphabetical Index
Indice alfabético
Index alphabétique
Indice alfabetico

SCHUKNECHT Tijera para cortar alambre	242
SEBILEAU Elevador	121
SEDILLOT Legras	127
SEMB Legras	138
SEMB Pinzas prensoras de huesos	195
SEMB-STILLE Pinzas gubias	183
Separador, instrumental para pelvis	101
Set servicio para aspirador	277
SEUTIN Tijera para vendajes	268
SHEEHAN Cinceles y gubias	146
SHERMAN STILLE Perforador de mano	284
SIEBENMANN Cucharillas cortantes	164
Sierra para yeso	271
Sierras de amputación	258-259
Sierras de calar para amputación	258
Sierras eléctricas oscilante para vendajes	274-276, 280-281
Sistemas de motores y perforadores de mano	274-289
SMEDBERG Perforador de mano	289
SMITH Tijera para vendajes	262
SMITH-PETERSEN Cinceles y gubias	159
SMITH-PETERSEN Pinzas gubias	180
SPRATT Cucharillas cortantes	170
STEINMANN Clavos	222-224
STELLBRINK Pinzas gubias	178
STILLE Cinceles y gubias	151
STILLE Cizallas para vendajes	269-270
STILLE LISTON Pinzas cortantes para huesos	189
STILLE-LUER Pinzas gubias	182
STILLE-MINI Cizalla para vendajes	269
STILLE Perforador de mano	284
STILLE Pinza gubia	183
STILLE SEMB Pinzas gubias	183
STILLE-SHERMAN Perforador de mano	284
T	
Taladro para huesos	200
TIGER Sierra eléctricas oscilante para vendajes	274-275
Tijeras para cortar alambre	241-243
Tijeras para cortar alambre HM	242-243
Tijeras para vendajes	262-268
Tope de profundidad para sierra para vendajes Oscillo Compact	281
Tornillo para compresión, DHPS	4
Tornillos canulados	104-105, 109-110, 113-114
Tornillos corticales de reconstrucción	88, 90
Tornillos corticales para fragmentos grandes	71

Tornillos corticales para mini fragmentos	16, 20, 25
Tornillos corticales para pequeños fragmentos	48
Tornillos de conexión, DHPS	8-9
Tornillos de hueso en titanio para placas radiales	43
Tornillos de huesos con cabeza en cruz	43
Tornillos de reconstrucción	88-92
Tornillos de tracción, DHPS	4
Tornillos DHPS	4
Tornillos esponjosos para fragmentos grandes	72-73
Tornillos esponjosos de reconstrucción	89, 91-92
Tornillos esponjosos para fragmentos pequeños	49
Tornillos para fragmentos grandes	71-74
Tornillos para fragmentos pequeños	48-49
Tornillos para maléolo para fragmentos grandes	74
Tornillos para mini fragmentos	16, 20, 25
Trépano para perforadores de mano	285
Tornillos para placas radiales	43
U	
UFFENORDE Cucharillas cortantes	164
ULRICH Pinzas prensoras de huesos	196
UNIVERSAL Alicates planos	237
UNIVERSAL HM Tijeras para cortar alambre	242
UNIVERSAL Tijera para cortar alambre	242
UNIVERSAL Tijeras para vendajes	268
V	
Vaina para tornillos, DHPS	12
Vaina de guía, DHPS	9
Vainas para centrar, DHPS	7-8
Vainas para tornillos canulados	108, 112, 116
Vainas para tornillos para mini fragmentos	32-33
Vainas para tornillos para pelvis reconstrucción	95
Vainas para tornillos para pequeños fragmentos	56
Vainas para tornillos para fragmentos grandes	82
VAN BUREN Pinza prensora de huesos	190
VERBRUGGE-HOHMANN Elevadores para hueso	206
VERBRUGGE Pinza para huesos para pequeños fragmentos	60

VERBRUGGE Pinzas para huesos para fragmentos grandes	84
VERBRUGGE Pinzas prensoras de huesos	198, 199
Vista general de atornilladores para fragmentos grandes	75
Vista general de atornilladores para mini fragmentos	26
Vista general de atornilladores para pequeños fragmentos	50
VOLKMANN Cucharillas cortantes	167-168, 173
VOLKMANN Separador, instrumental para pelvis	101
W	
WAGNER Legras	135
WAGNER Martillo	144
WARD Legra	125
WEBER Estesiómetro	211
WEST Cinceles y gubias	147
WIBERG Legras	126
WILLIGER Cucharillas cortantes	165, 171
WILLIGER Elevadores	121
WILLIGER KAHRE Legras	125
WILLIGER Legras	124
WILLIGER Martillo	140
WOLFF-BÖHLER Pinzas para arrancar vendajes	272
Z	
ZAUFAL-JANSEN Pinza gubia	181



A

ADSON Pince-gouge	177
ADSON Rugines	127
Agrafes à os	250-251
Alésoirs à main	200
ALEXANDER Ciseaux burins et gouges	150
Amputation	253-260
Aperçu tournevis grands fragments	75
Aperçu tournevis mini fragments	26
Aperçu tournevis petits fragments	50
Aspirateurs pour scies à plâtre	277, 282

B

BABY LANGE Levier à os	202
BACON Pince-gouge	178
BANE Pince-gouge	175
Barreau pour os, instruments pelvins	101
BEEBEE Ciseaux coupe-fil	241
BENNET Elévateur	123
BENNETT Leviers à os	207
BERGMANN Ciseaux à pansements	266
BERGMANN (HIBBS) Maillets	141
BEYER Pincés-gouges	177, 181
BIER Scie à amputation	259
BIRCHER Davier à os	194
BIRCHER-GANSKE Davier à os	194
BLACK Limes à os	118
BLOUNT Agrafes à os	251
BLOUNT Leviers à os	208
BLUMENTHAL Pincés-gouges	175
BÖHLER Etriers à extension	230
BÖHLER WOLFF Pincés pour arracher les plâtres	272
Bride de fixation pour clé de tension	229
BRISTOW Rugine	129
BRÜNNINGS Ciseaux burins et gouges	148
BRUNS Ciseaux à pansements	267
BRUNS Curettes tranchantes	165, 169
BUCK Curettes tranchantes	165
BUCK-GRAMCKO Levier à os	201
BUNNELL Perforateur à main	286

C

CASPAR Pilon	149
CATLIN Couteaux à amputation	257
CHAMPIONNIERE Perforateur à os	200
CHARRIERE Scie à amputation	258
Cisailles à plâtre	269-270
Ciseaux à pansements	262-268
Ciseaux burins et gouges	141-161

Ciseaux burins et gouges avec lames échangeables	160-161
--	---------

Ciseaux coupe-fil	241-243
Ciseaux coupe-fil HM	242-243

Clé avec manche en T pour vis DHPS	8
------------------------------------	---

Clé de tension pour étriers à extension Kirschner	226, 229
---	----------

Clé torsé cardan pour plaque à tension	54, 80
Clé torsé combinaison pour plaque à tension	54, 80

Clés pour perforateurs à main	286-289
-------------------------------	---------

Clés pour scies électrique oscillante à plâtre	274, 276, 279
--	---------------

CLEVELAND Pince coupante à os	186
Clous médullaires	214-218
Clous médullaires à crochet	216-218

COBB Gouges	155
COBB Rugines	199
COHEN Elévateur	123

COLLIN Couteaux à amputation	256
COLLIN FARABEUF Rugines	128
COLLIN (LUCAE) Maillets	139

CORWIN-HEGAR HM Pincés serre-fil	238
COTTLE-KAZANJIAN Pince coupante à os	186
COTTLE-MEDICON Ciseaux burins	147

Couteaux à amputation	254-257
Couteaux à lambeaux	254
Couteaux à phalange	254
Couteaux à plâtre	271
Couteaux à résection	254-255

Crochet de traction pour Kirschner étriers à extension	225
Crochet pour nettoyage	39, 58, 84
Curettes tranchantes	163-173
CUSHING Rugines	130

--	--

--	--

--	--

--	--

--	--

--	--

--	--

--	--

--	--

--	--

--	--

--	--

DHPS Vis	4
DINGMAN Daviers à os	192
DINGMAN Leviers à os	202

Disque pour limiter la profondeur des lames de scie	278
Disques de fixation pour broches	228
Douille de forage universelle DHPS	11
Douilles de forage double DHPS	10-11
Douille pour vis DHPS	12
Douilles de forage pour grands fragments	78-79
Douilles de forage pour petits fragments	53-54
Douilles de forage pour vis cannelées	108, 112, 116
Douilles de forage pour mini fragments	29
Douilles pour centrer DHPS	7-8
Douilles pour tenir les vis cannelées	108, 112, 116
Douilles pour tenir les vis pour mini fragments	32-33
Douilles pour tenir les vis pour petits fragments	56
Douilles pour tenir les vis, pour grands fragments	82
Douilles pour tenir les vis, reconstruction	95
DOYEN Maillet	139

--	--

--	--

--	--

--	--

--	--

--	--

--	--

--	--

--	--

--	--

--	--

--	--

--	--

--	--

--	--

--	--

--	--

--	--

--	--

--	--

--	--

--	--

--	--



Alphabetischer Index
 Alphabetical Index
 Índice alfabético
 Index alphabétique
 Índice alfabético

FARABEUF-LAMBOTTE Pince à reposition pelvienne	99
FARABEUF Rugines	128
FERGUSSON Davier à os	198
Fils d'acier à os	231
Fils et instruments pour fils métalliques	220-248
Fixation douille de forage pour petits fragments	53
Foret pour vis cruciformes titane	44
Forets DHPS	10
Forets hélicoïdaux pour perforateur à main	283, 285, 288
Forets pour mini fragments	27
Forets pour grands fragments	76
Forets pour petits fragments	51
Forets pour vis cannelées	106, 111, 115
Forets pour reconstruction	93
Fraises pour vis cannelées	106, 111, 115
Fraises pour mini fragments	28
Fraises pour grands fragments	77-78
Fraises pour perforateurs à main	285
Fraise pour petits fragments	52
FREER Ciseaux burins	147
FREER Elévateurs	122
FRIEDMANN Pince-gouge	174
G	
GALLAHER Limes à os	
GANSKE BIRCHER Davier à os	194
GEIGER Pince-gouge	180
GERZOG Maillet	140
GOLIATH HM Pince coupe-fil	247
Goniomètre	212
Goniomètre pour doigts de mains	212
Gouges	146-156, 158-161
GRAMCKO BUCK Levier à os	201
Grands fragments et série	61-84 / 298-300
Guide broche DHPS	6
Guide de profondeur	6
Guide de profondeur pour la scie à plâtre Oscillo Compact	281
Guides DHPS	5
H	
HAJEK Maillets	139
HALLE Curettes tranchantes	170
HARDT-DELIMA Ciseaux burins	145
HARMS HM Pince coupe-fil	247
HARTMANN Pince-gouge	176
HARVEY Ciseaux coupe-fil	242

HEGAR CORWIN HM Pincés serre-fil	238
HEMINGWAY Curettes tranchantes	172
HENAHAN Elévateurs	121
HENNIG Ecarteur à plâtre	272
HERNANDEZ-ROS Extracteur d'agrafes	250
HERNANDEZ-ROS Pilon pour agrafes	250
HERNANDEZ-ROS Porte-agrafes	250
HIBBS BERGMANN Maillet	141
HIBBS Ciseaux burins et gouges	152
HM Ciseaux coupe-fil	241-243
HM Pincés coupe-fil	243-248
HM Pince pour couper les plaques et les fils	37, 58
HM Pincés serre-fil	236, 238
HOEN Elévateurs	121
HOHMANN Leviers à os	205
HOHMANN LANGE Leviers à os	203
HOHMANN LANGE MODIF. Leviers à os	204
HOHMANN VERBRUGGE Leviers à os	206
HOPKINS Couteau à plâtre	271
I	
Impacteur DHPS	9
Impacteur et extracteur pour clous médullaires à crochet	218
Impacteur pour l'insertion de clous médullaires de Ender	214
Impacteur/extracteur pour de clous médullaires de Ender	215
Impacteurs pour agrafes à os	254
Inserts de tournevis pour mini fragments	31
Inserts de tournevis pour grands fragments	81
Inserts de tournevis pour petits fragments	55
Inserts pour tournevis	209
Instrument pour extraction des clous médullaires de Ender	215
Instrument pour l'insertion de clous médullaires de Ender	214
Instruments à pansements et à plâtre	262-272
Instruments à plâtre et à pansements	262-272
Instruments de base	117-212
Instruments de mesure	211-212
Instruments pour DHPS et série DHPS	5-12, 292
Instruments mini fragments et série	293-295
Instruments pelvins	93-102
Instruments pour agrafes à os	250-251
Instruments pour grands fragments	76-84
Instrument pour mesurer la profondeur pour DHPS	12

Instrument pour mesurer la profondeur pour grands fragments	82
Instruments pour mesurer la profondeur pour mini fragments	34
Instrument pour mesurer la profondeur pour petits fragments	56
Instrument pour mesurer la profondeur pour reconstruction	96
Instruments pour petits fragments	51-60
Instruments pour suture à agrafes	249-251
Instruments pour vis cannelées	106-108, 111-112, 115-116
J	
JAMESON Pied à coulisse	212
JANSEN Curettes tranchantes	171-172
JANSEN Pincés-gouges	177, 178
JANSEN ZAUFAL Pincés-gouges	181
Jauge de profondeur pour les vis DHPS	12
Jauge de profondeur pour les vis, petits fragments	56
Jauge de profondeur pour les vis, grands fragments	82
Jauge de profondeur pour les vis, reconstruction	96
Jauges de profondeur pour les vis mini fragments	34
Jeu de tournevis	209
JOSEPH Limes à os	118
JOSEPH Rugines	125
K	
KAHRE-WILLIGER Rugines	125
KAZANJIAN COTTLE Pince coupante à os	186
KERN Daviers à os	185
KERPEL Curettes tranchantes	163
KEY LISTON Pince coupante à os	189
KEY Rugines	129
KIRK Maillet	141
KIRMISSION Rugine	128
KIRSCHNER Broches	220-221
KIRSCHNER Etriers à extension	226-228
KIRSCHNER MOD. USA Etriers à extension	225
KIRSCHNER Tubes pour broches	224
KISTLER-MANUS Davier à os	191
KLEINERT-KUTZ Pincés-gouges	171, 179
KNOWLES Ciseaux à pansements	262
KÖNIG Rugine	124
KRÄMER Rugines	126
KUTZ KLEINERT Pincés-gouges	177, 179



L	
LAMBOTTE Ciseaux burins	162
LAMBOTTE FARABEUF Davier à os	198
LAMBOTTE FARABEUF Pince à reposition pelvienne	99
LAMBOTTE Levier à os	202
LAMBOTTE MINI Ciseaux burins	145
LAMBOTTE Rugines	129
Lame de scie en segments	279
Lame de scie pour profondeur	279
Lame de tournevis pour vis cruciformes	44
Lames ciseaux burin	160
Lames de rechange pour cisailles à plâtre	269-270
Lames de rechange pour scies à amputation	258-259
Lames gouges	161
Lames ostéotome	161
Lames pour scies électrique oscillante à plâtre	274, 276, 278-279, 281
LANE Daviers à os	197
LANE Levier à os	202
LANE MURPHY Leviers à os	207
LANGE-BABY Leviers à os	202
LANGE Ciseaux à pansements	263
LANGE-HOHMANN Leviers à os	203
LANGE-HOHMANN MODIF. Leviers à os	204
LANGE Leviers à os	203
LANGENBECK Couteaux à lambeaux	254
LANGENBECK Couteaux à résection	254, 255
LANGENBECK Davier à os	197
LANGENBECK Elévateurs	122
LANGENBECK Rugines	130
LANGENBECK Scie à guichet pour l'amputation	258
LEKSELL Pincés-gouges	184-185
LEMPERT Curettes tranchantes	170
LEMPERT Pincés-gouges	179
LEMPERT Rugines	126
Levier à pelvienne	102
Levier à plier pour clous médullaires de Ender	215
Levier de pliage pour broches de Kirschner, des petits fragments	57
Levier de pliage pour broches de Kirschner, mini fragments	36
Levier de pliage pour les plaques, pour grands fragments	82
Levier de pliage pour plaques de reconstruction	96
Leviers à os	201-208

Leviers à os pour mini fragments	40
Leviers à os pour petits fragments	60
Leviers de pliage pour les plaques pour mini fragments	35
Leviers de pliage pour les plaques, des petits fragments	57
LEWIN Davier à os	191
LEXER Ciseaux burins et gouges	154
LEXER Gouges	165
LEXER MINI Ciseaux burins et gouges	153
Limes à os	118-120
LISTER Ciseaux à pansements	264-265
LISTER-EXCENTRIC Ciseaux à pansements	264
LISTON Couteaux à amputation	255
LISTON Couteaux à phalange	254
LISTON-KEY Pince coupante à os	189
LISTON LITTAUER Pince coupante à os	186
LISTON-MINI Pincés coupantes à os	187
LISTON Pincés coupantes à os	187
LISTON RUSKIN Pincés coupantes à os	188
LISTON-STILLE Pincés coupantes à os	189
LITTAUER-LISTON Pince coupante à os	186
LORENZ Ciseaux à pansements	263
LOUTE Tendeur-fil	234
LOWMAN Daviers à os	198
LOWMAN Daviers pour la fixation des fragments	198
LUCAE COLLIN Maillet	139
LUER Pincés-gouges	175-176
LUER STILLE Pincés-gouges	182
M	
MACDONALD Elévateur	123
Maillets	139-144
Manche T avec accouplement rapide	7, 11
Manches avec accouplement rapide	30, 106
Manches de tournevis	44
Manche en T avec accouplement rapide	11, 55, 81, 94, 111
Manche pour tournevis	209
Manches de tournevis pour mini fragments	30
MANUS KISTLER Davier à os	191
MARQUARDT Pince-gouge	182
MARTIN Daviers à os	193
MARTINI Curettes tranchantes	171
MCINDOE Pincés coupantes à os	188
MCKENTY Rugines	125
MEAD Maillet	140
MEAD Pincés-gouges	174
MEAD Rugine	124
MEDICON Ciseaux à pansements	268

MEDICON COTTLE Ciseaux burins	147
MEDICON HM Pince serre-fil	236
MEDICON Pince serre-fil	236
Mètres à rubans	211
MEYHOEFER Curettes tranchantes	163
MILLER Limes à os	119
Mini fragment et série	13-40, 293-295
MINI-LAMBOTTE Ciseaux burins	145
MINI-LEXER Ciseaux burins et gouges	153
MINI LISTON Pincés coupantes à os	187
MINI RUSKIN Pincés-gouges	179
MINI STILLE Cisaille à plâtre	269
MOD. USA Ecarteur à plâtre	272
MÖLTGEN Goniomètre	212
MOLT Rugines	124
MOORE Perforateur à main	283
MURPHY-LANE Leviers à os	207
N	
NIRO HM Pince serre-fil	236
NIRO Pince coupante à os	186
NIRO Pincés serre-fil	236
O	
OLIVECRONA Pince-gouge	176
OLIVECRONA Rugine	127
OMBREDANNE Maillet	142
OSCI-CLEAN Aspirateur pour scie à plâtre Oscillo Compact	282
OSCILLO COMPACT Scie électrique oscillante à plâtre	280-281
OSCILLO V Scie électrique oscillante à plâtre	276
P	
PARTSCH Ciseaux burins et gouges	146
Passe-fils	232-233
PASSOW Poussoirs à os	148
PERCY Rétracteur à amputation	260
Perforateur à os	200
Perforateurs à main	283-289
Perforateurs initiaux pour clous médullaires à crochet	218
PERTHES Alésoirs à main	200
PETERSEN SMITH Ciseaux burins et gouges	159
PETERSEN SMITH Pincés-gouges	180
Petits fragments et série	45-60, 296-297
Pieds à coulisse	212
Pilon pour agrafes	250
Pince à réposition pour mini fragments	38



Alphabetischer Index
Alphabetical Index
Indice alfabético
Index alphabétique
Indice alfabético

Pinces à reposition pelvienne	98-100
Pince coupante pour fil et clous	248
Pince de pliage pour plaques mini	36
Pince de pliage pour plaques mini de reconstruction	96
Pince pour couper les fils et les plaques HM	37, 58
Pince pour tenir les vis	12, 56, 108, 112
Pince pour tenir les vis mini fragments	36
Pinces à cartilage	193-194
Pinces à extraction clous	239-240
Pinces à extraction fils	239-240
Pinces à ménisque	193-194
Pinces à reposition	191
Pinces à séquestre	190
Pinces coupantes à os	186-189
Pinces coupe-fil	243-248
Pinces coupe-fil HM	243-247
Pinces plates	37, 58, 236-238
Pinces pour arracher les plâtres	272
Pinces pour tenir les plaques mini fragments	38
Pinces serre-fil	236-238
Pinces serre-fil HM	236-238
Pinces-gouges	174-185
Plaque à tension	54, 80
Plaque à tension pour petits fragments	54
Plaque d'appui pour pincés de reposition	101
Plaque multifragments pour mini fragments	23
Plaques condyliques pour mini fragments	15, 19, 24
Plaques d'appui condilaire pour grands fragments	66
Plaques d'appui en forme de L pour grands fragments	64
Plaques d'appui en forme de T pour grands fragments	65
Plaques de compression des grands fragments	62
Plaques de compression mini fragments	14, 17, 21
Plaques de compression pour petits fragments	46
Plaques de préformation pour plaques de reconstruction	97
Plaques de préformation, pour petits fragments	57
Plaques de préformation pour grands fragments	83
Plaques de reconstruction	86-87
Plaques DHPS	2-3

Plaques en cuillère pour grands fragments	65
Plaques en forme de H pour mini fragments	14
Plaques en forme de L pour mini fragments	18-19, 22-23
Plaques en forme de T mini fragments	14, 17-18, 22
Plaques en forme de T pour petits fragments	47
Plaques en forme de T pour grands fragments	63, 65
Plaques pour mini fragments	14-15, 17-19, 21-24
Plaques pour femur pour grands fragments	67
Plaques pour grands fragments	62-70
Plaques pour petits fragments	46-47
Plaques pour tête de tibia pour grands fragments	69
Plaques pour tibia pour grands fragments	68-70
Plaques quart tubulaire pour mini fragments	21
Plaques radius en forme de Y, titane	42
Plaques semi tubulaires pour grands fragments	63
Plaques supra condyliques	3
Plaques T mini fragments	14, 17-18, 22
Plaques trèfles pour petits fragments	47
Plaques tritubulaires pour petits fragments	46
Porte-agrafes	250
Poussoirs à os	148
Presse pour plier les plaques à os, pour grands fragments	83
PUTTI Limes à os	118
R	
RALK Perforateur à main	288
Reconstruction	85-92
Règles en acier inoxydable	211
REINER Couteau à plâtre	271
Rétracteur à amputation	260
Rondelle pour vis malléole, grands fragments	74
Rondelle pour vis spongieuse, petits fragments	49
Rondelle pour vis spongieuses, grands fragments	73
Rondelles pour vis cannulées	105, 110, 114
Rondelles pour vis corticales, mini fragments	16, 20, 25
Rondelles pour vis spongieuses de reconstruction	89, 91, 92
ROS HERNANDEZ Extracteur d'agrafes	250
ROS HERNANDEZ Pilon pour agrafes	250

ROS HERNANDEZ Porte-agrafes	250
ROWLAND RUSKIN Pincés coupantes à os	188
Rugine pour mini fragments	39
Rugine pour petits fragments	59
Rugines	124-138
RUSKIN-LISTON Pincés coupantes à os	183
RUSKIN-MINI Pincés-gouges	179
RUSKIN Pincés-gouges	180, 181
RUSKIN-ROWLAND Pincés coupantes à os	188
RUST Scie à amputation	259
S	
Sac papier de rechange pour aspirateur Oscy-Clean	282
SATTERLEE Scie à amputation	258
SCHANZ Vis	102, 224
SCHEDÉ Curettes tranchantes	167
SHELL Pince-gouge	175
SCHUKNECHT Ciseaux coupe-fil	272
Scie à plâtre	271
Scies à amputation	258-259
Scies à guichet pour l'amputation	258
Scies électrique oscillante à plâtre	274-276, 280-281
SEBILÉAU Elévateurs	121
SEDILLOT Rugines	127
SEMB Daviers à os	195
SEMB Rugines	138
SEMB-STILLE Pincés-gouges	183
Set service pour aspirateur	277
SEUTIN Ciseaux à pansements	268
SHEEHAN Ciseaux burins et gouges	146
SHERMAN STILLE Perforateur à main	284
SIEBENMANN Curettes tranchantes	164
SMEDBERG Perforateur à main	289
SMITH Ciseaux à pansements	262
SMITH-PETERSEN Ciseaux burins et gouges	159
SMITH-PETERSEN Pincés-gouges	180
SPRATT Curettes tranchantes	170
STEINMANN Clous	222-224
STELLBRINK Pincés-gouges	178
STILLE Cisailles à plâtre	269-270
STILLE Ciseaux burins et gouges	151
STILLE LISTON Pincés coupantes à os	189
STILLE-LUER Pincés-gouges	182
STILLE-MINI Cisaille à plâtre	269
STILLE Perforateur à main	284
STILLE Pince-gouge	183
STILLE SEMB Pincés-gouges	183
STILLE-SHERMAN Perforateur à main	284



Systèmes de moteurs et perforateurs à main	274-289
--	---------

T

Tarauds pour DHPS	7, 10
Tarauds pour mini fragments	27
Tarauds pour grands fragments	76-77
Tarauds pour petits fragments	51,52
Tarauds pour vis corticales, reconstruction	93
Tendeurs-fil	234-235
Tige guide DHPS	9
TIGER Scie électrique oscillante à plâtre	274-275
Tournevis	209-210
Tournevis canulé	107, 112, 116
Tournevis cruciformes	44
Tournevis pour petits fragments	55
Tournevis DHPS	11
Tournevis hexagonal	11, 209-210
Tournevis pour mini fragments	30-32
Tournevis pour grands fragments	81-82
Tournevis reconstruction	94-95
Tréphine pour perforateurs à main	285
Triple forets pour plaques DHPS	6
Tubes pour broches	224

U

UFFENORDE Curettes tranchantes	164
ULRICH Daviers à os	196
UNIVERSAL Ciseaux à pansements	268
UNIVERSAL Ciseaux coupe-fil	242
UNIVERSAL HM Ciseaux coupe-fil	242
UNIVERSAL Pincés plates	237

V

Valise plastique pour la scie à plâtre Oscillo Compact	281
VAN BUREN Davier à os	190
VERBRUGGE Davier à os pour petits fragments	60
VERBRUGGE Daviers à os	198, 199
VERBRUGGE Daviers à os pour grands fragments	84
VERBRUGGE-HOHMANN Leviers à os	206
Vis à compression DHPS	4
Vis à os cruciformes	43
Vis à os titane pour plaques radius	43
Vis à traction DHPS	4
Vis canulées	104-105, 109-110, 113-114
Vis corticales de reconstruction	88, 90
Vis corticales pour grands fragments	71
Vis corticales pour mini fragments	16, 20, 25

Vis corticales pour petits fragments	48
Vis de jonction DHPS	8-9
Vis de reconstruction	88-92
Vis DHPS	4
Vis malléoles pour grands fragments	74
Vis pour grands fragments	71-74
Vis pour mini fragments	16, 20, 25
Vis pour petits fragments	48-49
Vis pour plaques radius	43
Vis spongieuses de reconstruction	89, 91-92
Vis spongieuses pour grands fragments	72-73
Vis spongieuses pour petits fragments	49
VOLKMANN Curettes tranchantes	167-168, 173
VOLKMANN Ecarteur, instruments pelvins	101

W

WAGNER Maillet	144
WAGNER Rugines	135
WARD Rugines	125
WEBER Estésiomètre	211
WEST Ciseaux burins et gouges	147
WIBERG Rugines	126
WILLIGER Curettes tranchantes	165, 171
WILLIGER Elévateurs	121
WILLIGER KAHRE Rugines	125
WILLIGER Maillets	140
WILLIGER Rugines	124
WOLFF-BÖHLER Pincés pour arracher les plâtres	272

Z

ZAUFAL-JANSEN Pincés-gouges	181
-----------------------------	-----



Alphabetischer Index
Alphabetical Index
Indice alfabético
Index alphabétique
Indice alfabetico

A	
ADSON Periostotomi	127
ADSON Pinza sgorbia	177
Aghi passafilo	232-233
Agrafes per ossa	250-251
Alesatori	200
ALEXANDER Scalpelli e sgorbie	150
Allargagessi	272
Amputazione	230-260
Aspiratoi per seghe per gesso	277, 282
B	
BABY LANGE Elevatore per ossa	202
BACON Pinza sgorbia	178
BANE Pinza sgorbia	175
Barra per osso, strumenti pelvici	101
BEEBEE Forbici per fili d'acciaio	241
BENNET Elevatore	123
BENNETT Elevatori per ossa	207
BERGMANN Forbice per bendaggi	266
BERGMANN (HIBBS) Martello	141
BEYER Pinze sgorbie	177, 181
BIER Sega per amputazione	259
BIRCHER-GANSKE Tenaglia per ossa	194
BIRCHER Tenaglia per ossa	194
BLACK Lime per ossa	118
BLOUNT Agrafes per ossa	251
BLOUNT Elevatori per ossa	208
BLUMENTHAL Pinze sgorbie	175
Boccola di centraggio per DHPS	7-8
Boccola per viti per DHPS	12
Boccole per viti cannulate	108, 112, 116
Boccole per viti di ricostruzione	95
Boccole per viti per frammenti grandi	82
Boccole per viti per frammenti piccoli	56
Boccole per viti per mini frammenti	32-33
BÖHLER Staffe per trazione	230
BÖHLER WOLFF Pinze strappagessi	272
BRISTOW Periostotomo	129
BRÜNINGS Scalpelli e sgorbie	148
BRUNS Cucchiali taglienti	165, 169
BRUNS Forbici per bendaggi	267
BUCK Cucchiali taglienti	165
BUCK-GRAMCKO Elevatore per ossa	201
BUNNELL Trapano a mano	286
Bussole di foratura per frammenti grandi	78-79
Bussole di foratura per frammenti piccoli	53-54
Bussole di foratura per mini frammenti	29

Bussole di foratura per viti cannulate	107, 112, 116
C	
Cacciavite	209-210
Cacciavite cannulato	107, 112, 116
Cacciavite con presa a croce	44
Cacciavite di ricostruzione	94-95
Cacciaviti esagonale	11, 209-210
Cacciavite per DHPS	11
Cacciavite per frammenti grandi	81-82
Cacciaviti per frammenti piccoli	55
Cacciaviti per mini frammenti	30-32
Calibre micrometrico	212
Calibro di profondità	6
CASPAR Scalpelli e sgorbie	149
CATLIN Pestello	257
Centrapunte doppia per DHPS	10-11
Centrapunta per frammenti piccoli	53
Centrapunta universale per DHPS	11
Cesoie per gesso	269-270
CHAMPIONNIERE Perforatore per ossa	200
CHARRIERE Sega per amputazione	258
Chiave anello/forchetta per tenditore di placca	80
Chiave cardan per tenditore di placche	80
Chiave con manico a T per viti per DHPS	8
Chiave di serraggio per trapani a mano	286-289
Chiave per staffe per trazione Kirschner	226, 229
Chiavi per seghe elettriche oscillante per gesso	274, 276, 279
Chiodi midollari	214-218
Chiodi midollari ad uncino	216-218
CLEVELAND Pinza ossivora	186
COBB Periostotomi	133
COBB Sgorbie	155
COHEN Elevatore	123
COLLIN Coltello per amputazione	257
COLLIN FARABEUF Periostotomo	128
COLLIN (LUCAE) Martello	139
Coltelli per amputazione	254-257
Coltelli per gesso	271
Coltelli per resezione	254-255
Coltello per falangi	254
Contenitori per fili	224
CORWIN-HEGAR HM Pinze tendifili	238
COTTLE-KAZANJIAN Pinza ossivora	186
COTTLE-MEDICON Scalpelli	147
Cucchiali taglienti	167-173
CUSHING Periostotomi	130

D	
DAHMEN Scalpelli e sgorbie	157-158
DAUBENSPECK Cucchiali taglienti	164
DEFOURMENTEL Pinza sgorbia	178
DELIMA HARDT Scalpelli	145
DEMEL Aghi passafilo	232
DEMEL Tendifilo	234
DHPS Placche	2-3
DHPS Strumenti / DHPS serie	5-12 / 292
DHPS Viti	4
DINGMAN Elevatori per ossa	202
DINGMAN Tenaglie per ossa	192
Dischi di fissaggio per perforatori filiformi	228
Disco per lame da sega	278
Divaricatore, strumenti pelvici	101
DOYEN Martello	139
E	
EASY CUT HM Tenaglia tagliafilii	246
ECHLIN Pinze sgorbie	185
Elevatore pelvico	102
Elevatori	121-123
Elevatori per ossa	201-208
Elevatori per ossa per frammenti piccoli	60
Elevatori per ossa per mini frammenti	40
ENDER Chiodi midollari	214-215
ENGEL Sega per gesso	271
ESMARCH Coltello per gesso	271
ESMARCH Forbici per bendaggi	266
Estrattore di agrafes	250
Estrattore per chiodi midollari ad uncino	218
Estrattore/introdotto per chiodi midollari Ender	215
EXCENTRIC LISTER Forbici per bendaggi	264
F	
FARABEUF-COLLIN Periostotomi	128
FARABEUF-LAMBOTTE Pinza di riposizione	100
FARABEUF-LAMBOTTE Tenaglia per ossa	198
FARABEUF Periostotomi	128
FARABEUF Tenaglie per ossa	198
FERGUSSON Tenaglia per ossa	198
Filettatori per DHPS	7, 10
Filettatori per frammenti grandi	76-77
Filettatori per frammenti piccoli	51-52
Filettatori per mini frammenti	27



Alphabetischer Index
 Alphabetical Index
 Índice alfabético
 Index alphabétique
 Indice alfabetico

Filettatori per viti corticalis di ricostruzione	93
Fili d'acciaio e strumenti per fili d'acciaio	220-248
Fili d'acciaio per ossa	231
Filo guida per DHPS	6
Forbici per bendaggi	262-268
Forbici per fili d'acciaio	241-243
Forbici per fili d'acciaio HM	242-243
Frammenti grandi e serie	61-84, 298-300
Frammenti piccoli s serie	45-60, 296-297
FREER Elevatori	122
FREER Scalpelli	147
Fresa per frammenti piccoli	52
Frese per viti cannulate	106, 111, 115
Frese per frammenti grandi	77-78
Frese per mini frammenti	28
Frese per trapani a mano	285
FRIEDMANN Pinza sgorbia	174
G	
GALLAHER Lime per ossa	118
Gancio di trazione per Kirschner staffe per trazione	225
GANSKE BIRCHER Tenaglia per ossa	134
GEIGER Pinza sgorbia	180
GERZOG Martello	140
GOLIATH HM Tenaglia tagliafili	247
Goniometro	212
Goniometro per le dita	212
GRAMCKO BUCK Elevatore per ossa	201
Guida di profondità per sega Oscillo Compact	281
Guida per DHPS	9
H	
HAJEK Martello	139
HALLE Cucchiali taglienti	170
HARDT-DELIMA Scalpelli	145
HARMS HM Tenaglia tagliafili	247
HARTMANN Pinza sgorbia	176
HARVEY Forbice per fili d'acciaio	242
HEGAR CORWIN HM Pinze tendifili	238
HEMINGWAY Cucchiali taglienti	172
HENAHAN Elevatori	121
HENNIG Allargagessi	272
HERNANDEZ-ROS Estrattore di agrafes	250
HERNANDEZ-ROS Impattatore per agrafes	250
HERNANDEZ-ROS Porta-agrafes	250
HIBBS BERGMANN Martello	141
HIBBS Scalpelli e sgorbie	152
HM Forbici per fili d'acciaio	241-243

HM Pinza per tagliare placche e fili	37, 58
HM Pinze tendifili	236, 238
HM Tenaglie tagliafili	243-248
HOEN Elevatori	121
HOHMANN Elevatori per ossa	205
HOHMANN LANGE Elevatori per ossa	203
HOHMANN LANGE MODIF. Elevatori per ossa	204
HOHMANN VERBRUGGE Elevatori per ossa	206
HOPKINS Coltello per gesso	271
I	
Impattatore per agrafes	250
Impattatori per ossa	148
Inseri per cacciavite per mini frammenti	31
Inseri per cacciaviti	209
Inseri per trapani a mano	283, 285
Insero per cacciavite per frammenti grandi	288
Inseri per cacciavite per frammenti piccoli	55
Introduttore per DHPS	9
Introduttore per inserire chiodi midollari Ender	214
Introduttore/estrattore per chiodi midollari Ender	215
Introduttori per agrafes per ossa	251
J	
JAMESON Calibor micrometrico	212
JANSEN Cucchiali taglienti	171-172
JANSEN Pinze sgorbie	177, 178
JANSEN ZAUFAL Pinza sgorbia	181
JOSEPH Lime per ossa	118
JOSEPH Periostotomo	125
K	
KAHRE-WILLIGER Periostotomo	125
KAZANJIAN COTTLE Pinza ossivora	186
KERN Tenaglie per ossa	195
KERPEL Cucchiali taglienti	163
KEY LISTON Pinza ossivora	189
KEY Periostotomi	129
KIRK Martello	141
KIRMISSION Periostotomo	128
KIRSCHNER Contenitori per fili	224
KIRSCHNER Fili perforatori	220-221
KIRSCHNER MOD. USA Staffe per trazione	225
KIRSCHNER Staffe per trazione	226-228

KISTLER-MANUS Tenaglia per ossa	191
KLEINERT-KUTZ Pinze sgorbie	177, 179
KNOWLES Forbici per bendaggi	262
KÖNIG Periostotomo	124
KRÄMER Periostotomi	126
KUTZ KLEINERT Pinze sgorbie	177, 179
L	
Lama da sega profondità	279
Lama da sega segmento	279
Lama per cacciavite per viti con presa a croce	44
LAMBOTTE Elevatore per ossa	202
LAMBOTTE FARABEUF Pinza di riposizione	100
LAMBOTTE FARABEUF Tenaglia per ossa	198
LAMBOTTE MINI Scalpelli	145
LAMBOTTE Periostotomi	129
LAMBOTTE Scalpelli	162
Lame di ricambio per cesoie per bendaggi	269-270
Lame di ricambio per seghe per amputazione	258-259
Lame per osteotomia	161
Lame per scalpello	160
Lame per seghe elettriche oscillante per gesso	274, 276, 278-279, 281
Lame per sgorbie	161
LANE Elevatore per ossa	202
LANE MURPHY Elevatore per ossa	207
LANE Tenaglie per ossa	197
LANGE-BABY Elevatore per ossa	202
LANGE Elevatori per ossa	203
LANGE Forbice per bendaggi	263
LANGE-HOHMANN Elevatori per ossa	203
LANGE-HOHMANN MODIF. Elevatori per ossa	204
LANGENBECK Coltelli per resezione	254
LANGENBECK Coltello per amputazione	254, 255
LANGENBECK Elevatori	122
LANGENBECK Periostotomi	130
LANGENBECK Sega a coda di topo per amputazione	258
LANGENBECK Tenaglia per ossa	197
LEKSELL Pinze sgorbie	184-184
LEMPERT Cucchiali taglienti	170
LEMPERT Periostotomi	126
LEMPERT Pinze sgorbie	179
Leva per piegare fili di Kirschner per frammenti piccoli	57



Alphabetischer Index
Alphabetical Index
Indice alfabético
Index alphabétique
Indice alfabético

Leva per piegare fili di Kirschner per mini frammenti	36
Leva piegaplacche di ricostruzione	96
Leva piegaplacche per frammenti grandi	82
Leva piegatrice per chiodi midollari Ender	215
Leve piegaplacche per frammenti piccoli	57
Leve piegaplacche per mini frammenti	35
LEWIN Tenaglia per ossa	191
LEXER MINI Scalpelli e sgorbie	153
LEXER Scalpelli e sgorbie	154
LEXER Sgorbie	156
Lime per ossa	118-120
LISTER-EXCENTRIC Forbici per bendaggi	264
LISTER Forbici per bendaggi	264-265
LISTON Coltello per amputazione	255
LISTON Coltello per falangi	254
LISTON-KEY Pinza ossivora	189
LISTON-LITTAUER Pinza ossivora	186
LISTON-MINI Pinze ossivore	187
LISTON Pinze ossivore	187
LISTON RUSKIN Pinze ossivore	188
LISTON-STILLE Pinze ossivore	189
LITTAUER-LISTON Pinza ossivora	186
LORENZ Forbice per bendaggi	263
LOUTE Tendifilo	234
LOWMAN Tenaglie per ossa	198
LUCAE COLLIN Martello	139
LUER Pinze sgorbie	175-176
LUER STILLE Pinze sgorbie	182
M	
MACDONALD Elevatore	123
Manici per cacciavite per mini frammenti	30
Manico a forma di T con accoppiamento rapido per ricostruzione	94
Manico a T con accoppiamento	7, 11, 55, 81, 94, 111
Manici con accoppiamento rapido	30, 106
Manici per cacciaviti	44, 209
MANUS KISTLER Tenaglia per ossa	191
MARQUARDT Pinza sgorbia	182
Martelli	139-144
MARTIN Tenaglie per ossa	193
MARTINI Cucchiari taglienti	171
MCINDOE Pinze ossivore	188
MCKENTY Periostotomo	125
MEAD Martello	140
MEAD Periostotomo	124
MEAD Pinze sgorbie	174

MEDICON COTTLE Scalpelli	147
MEDICON Forbice per bendaggi	268
MEDICON HM Pinza tendifili	236
MEDICON Pinza tendifili	236
MEYHOEFER Cucchiari taglienti	163
MILLER Lime per ossa	119
Mini frammenti e serie	13-40, 293-295
MINI-LAMBOTTE Scalpelli	145
MINI-LEXER Scalpelli e sgorbie	153
MINI LISTON Pinze ossivore	187
MINI RUSKIN Pinze sgorbie	179
MINI STILLE Cesoa per gesso	269
Mirini per DHPS	5
MOD. USA Allargagessi	272
MÖLTGEN Goniometro	212
MOLT Periostotomo	124
MOORE Trapano a mano	283
Morsetto per stringere il dado della chiave tenditrice	229
MURPHY-LANE Elevatore per ossa	207
N	
Nastri metrici	211
NIRO HM Pinza tendifili	236
NIRO Pinza ossivora	186
NIRO Pinze tendifili	236
O	
OLIVECRONA Periostotomo	127
OLIVECRONA Pinza sgorbia	176
OMBREDANNE Martello	142
OSCI-CLEAN Aspiratore per seghe per gessi Oscillo Compact	282
OSCILLO COMPACT Sega elettrica oscillante per gesso	280-281
OSCILLO V Sega elettrica oscillante per gesso	276
P	
PARTSCH Scalpelli e sgorbie	146
PASSOW Impattatori per ossa	148
PERCY Protettore per amputazione	260
Perforatore a tre livelli per placche per DHPS	6
Perforatore per ossa	200
Perforatore per viti in titanio con presa a croce	44
Perforatori a mano	231
Perforatori elicoidali per Trapani a mano	283, 285, 288
Perforatori per DHPS	10

Perforatori per frammenti grandi	76
Perforatori per frammenti piccoli	51
Perforatori per mini frammenti	27
Perforatori per ricostruzione	93
Perforatori per trapani a mano	285
Perforatori per viti cannulate	106, 111, 115
Periostotomo per frammenti piccoli	59
Periostotomi	124-138
Periostotomo per mini frammenti	39
PERTHES Alesatori	200
PETERSEN SMITH Pinze sgorbie	180
PETERSEN SMITH Scalpelli e sgorbie	159
Piegatrice per placche di osso per frammenti grandi	83
Pinze per riposizione, strumenti pelvici	98-100
Pinza per riposizione per mini frammenti	38
Pinza per tagliare placche e fili, HM	37, 58
Pinza piegaplacche per placche di ricostruzione	96
Pinza piegaplacche per placche mini	36
Pinza tagliente per fili e chiodi	248
Pinze di riposizione	98-100
Pinze ossivore	186-189
Pinze per estrazione di chiodi	239-240
Pinze per estrazione di fili	239-240
Pinze per riposizione	191
Pinze per sequestri	190
Pinze per tenere le placche per mini frammenti	38
Pinze per tenere viti	12, 36, 56, 106, 112
Pinze sgorbie	174-185
Pinze strappagessi	272
Pinze tendifili HM	296-298
Pinze tendifili d'acciaio	296-298
Placca a forma di H per mini frammenti	14
Placca condilica per mini frammenti	15, 19, 24
Placca di sostegno per pinze riposizione	101
Placca multi frammenti per mini di frammenti	23
Placche DHPS	2-3
Placche 1/3 tubolare per frammenti piccoli	46
Placche 1/4 tubolare per mini frammenti	21
Placche a forma di L per mini frammenti	18-19, 22-23



Alphabetischer Index
 Alphabetical Index
 Índice alfabético
 Index alphabétique
 Indice alfabetico

Placche a forma di T per frammenti grandi	63, 65
Placche a forma di T per frammenti piccoli	47
Placche a forma di T per mini frammenti	14, 17-18, 22
Placche a trifoglio per frammenti piccoli	47
Placche condilari per sostegno di frammenti grandi	66
Placche cucchiaino per frammenti grandi	65
Placche di compressione per frammenti grandi	62
Placche di compressione per frammenti piccoli	46
Placche di compressione per mini frammenti	14, 17, 21
Placche di ricostruzione	86-87
Placche di sostegno a forma di L per frammenti grandi	64
Placche di sostegno a forma di T per frammenti grandi	65
Placche femore per frammenti grandi	67
Placche per frammenti grandi	62-70
Placche per frammenti piccoli	46-47
Placche per mini frammenti	14-15, 17-19, 21-24
Placche per sostegno della testa tibiale per frammenti grandi	69
Placche per tibia per frammenti grandi	68-70
Placche raggio a forma di Y, titanio	42
Placche sagomabili per frammenti grandi	83
Placche sagomabili per frammenti piccoli	57
Placche sagomabili per placche di ricostruzione	97
Placche semitubolari per frammenti grandi	63
Placche supra condilari	3
Porta-agrafe	250
Protettore per amputazione	260
Punteruolo per chiodi midollari ad uncino	218
PUTTI Lime per ossa	118
R	
RALK Trapano a mano	288
REINER Coltello per gesso	271
Ricostruzione	85-92

Righe in acciaio inossidabile	211
Rondella per viti malleolari per frammenti grandi	74
Rondella per viti spongiosa per frammenti grandi	73
Rondella per viti spongiosa per frammenti piccoli	49
Rondelle per viti cannulate	105, 110, 114
Rondelle per viti corticalis per mini frammenti	16, 20, 25
Rondelle per viti spongiosa per ricostruzione	89, 91, 92
ROS HERNANDEZ Estrattore di agrafes	250
ROS HERNANDEZ Impattatore per agrafes	250
ROS HERNANDEZ Porta-agrafe	250
ROWLAND RUSKIN Pinze ossivore	188
RUSKIN-LISTON Pinze ossivore	188
RUSKIN-MINI Pinze sgorbie	179
RUSKIN Pinze sgorbie	180, 181
RUSKIN-ROWLAND Pinze ossivore	188
RUST Sega per amputazione	259
S	
Sacchetto di carta per aspiratore Osci-Clean	282
SATTERLEE Sega per amputazione	258
Scalpelli e sgorbie	146-162
Scalpelli e sgorbie con lame intercambiabili	160-161
SCHANZ Viti	102, 224
SCHEDE Cucchiaini taglienti	167
SCHELL Pinza sgorbia	175
SCHUKNECHT Forbice per fili d'acciaio	242
SEBILÉAU Elevatore	121
SEDILLOT Periostotomi	127
Sega elettrica oscillante per gesso	274-276, 280-281
Sega per gesso	271
Seghe a coda di topo per amputazione	258
Seghe per amputazione	258-259
SEMB Periostotomi	138
SEMB-STILLE Pinza sgorbia	183
SEMB Tenaglie per ossa	195
Set di cacciaviti	209
Set servizio per aspiratore	277
SEUTIN Forbice per bendaggi	268
Sgorbie	146-156, 158-161
SHEEHAN Scalpelli e sgorbie	146
SHERMAN STILLE Trapano a mano	284
SIEBENMANN Cucchiaini taglienti	164
Sistemi di motore e trapano a mano	274-289

SMEDBERG Trapano a mano	289
SMITH Forbice per bendaggi	262
SMITH-PETERSEN Pinze sgorbie	180
SMITH-PETERSEN Scalpelli e sgorbie	159
SPRATT Cucchiaini taglienti	170
Staffe per trazione	225-230
STEINMANN Chiodi	222-224
STELLBRINK Pinze sgorbie	178
STILLE Cesioie per gesso	269-270
STILLE LISTON Pinze ossivore	189
STILLE-LUER Pinze sgorbie	182
STILLE-MINI Cesioia per gesso	269
STILLE Pinza sgorbia	183
STILLE Scalpelli e sgorbie	151
STILLE SEMB Pinza sgorbia	183
STILLE Trapano a mano	284
STILLE-SHERMAN Trapano a mano	284
Strumentario per aggraffatura	249-251
Strumenti di base	117-212
Strumenti pelvici	93-102
Strumenti per agrafes per ossa	250-251
Strumenti per bendaggi e gesso	262-272
Strumenti per DHS e serie	292
Strumenti per frammenti grandi e serie	76-84, 298-300
Strumenti per frammenti piccoli e serie	51-60, 296-297
Strumenti per mini frammenti e serie	26-40, 293-295
Strumenti per misurare la profondità per viti per mini frammenti	34
Strumenti per misurazione	211-212
Strumenti per viti cannulate	106-108, 111-112, 115-116
Strumenti per viti in titanio con presa a croce	234-235
Strumenti tendifilo	220
Strumento estrattore per chiodi femorali	220
Strumento estrattore per chiodi midollari	215
Strumento per estrazione di chiodi midollari Ender	214
Strumento per inserire chiodi midollari Ender	214
Strumento per misurare la profondità per viti DHS	12
Strumento per misurare la profondità per viti per frammenti piccoli	56
Strumento per misurare la profondità per ricostruzione	96



Alphabetischer Index
Alphabetical Index
Índice alfabético
Index alphabétique
Índice alfabético

Strumento per misurare la profondità per frammenti grandi	82
Strumento per misurazione per DHPS	8
T	
Tenaglia per ossa autocentrante per mini frammenti	39
Tenaglie per cartilagine	193-194
Tenaglie per menisco	193-194
Tenaglie per ossa	190-199
Tenaglie per ossa per frammenti grandi	84
Tenaglie per ossa per frammenti piccoli	59-60
Tenaglie piatte	37, 58, 236-238
Tenaglie tagliafilii	243-248
Tenaglie tagliafilii HM	243-247
Tenditore di placche per frammenti grandi	80
Tenditore di placche per frammenti piccoli	54
TIGER Sega elettrica oscillante per gesso	274-275
Trapani a mano	283-289
U	
UFFENORDE Cucchiali taglienti	164
ULRICH Tenaglie per ossa	196
Uncino per pulizia	39, 58, 84
UNIVERSAL Forbice per fili d'acciaio	252
UNIVERSAL Forbici per bendaggi	268
UNIVERSAL HM Forbici per fili d'acciaio	242
UNIVERSAL Tenaglie piatte	237
V	
Valigetta di plastica per sega Oscillo Compact	281
VAN BUREN Tenaglia per ossa	190
VERBRUGGE-HOHMANN Elevatori per ossa	206
VERBRUGGE Tenaglia per ossa per frammenti piccoli	60
VERBRUGGE Tenaglie per ossa	198, 199
VERBRUGGE Tenaglie per ossa per frammenti grandi	84
Visione generale del cacciavite per frammenti grandi	75
Visione generale del cacciavite per frammenti piccoli	52
Visione generale del cacciavite per mini frammenti	26
Vite di compressione per DHPS	4
Viti di raccordo per DHPS	8-9
Vite per placche raggio	43
Viti cannulate	104-105, 109-110, 113-114
Viti corticalis di ricostruzione	88, 90

Viti corticalis per frammenti grandi	71
Viti corticalis per frammenti piccoli	48
Viti corticalis per mini frammenti	16, 20, 25
Viti di ricostruzione	88-92
Viti di trazione per DHPS	4
Viti malleolari per frammenti grandi	74
Viti per DHPS	4
Viti per frammenti grandi	71-74
Viti per frammenti piccoli	48-49
Viti per mini frammenti	16, 20, 25
Viti per ossa con presa a croce, titanio	43
Viti per ossa per placche raggio	43
Viti spongiosa di ricostruzione	89, 91-92
Viti spongiosa per frammenti grandi	72-73
Viti spongiosa per frammenti piccoli	49
VOLKMANN Cucchiali taglienti	167-168, 173
VOLKMANN Divaricatore, strumenti pelvici	101
W	
WAGNER Martello	144
WAGNER Periostotomi	135
WARD Periostotomo	125
WEBER Estesometro	211
WEST Scalpelli e sgorbie	147
WIBERG Periostotomi	126
WILLIGER Cucchiali taglienti	165, 171
WILLIGER Elevatori	121
WILLIGER KAHRE Periostotomi	125
WILLIGER Martello	140
WILLIGER Periostotomi	124
WOLFF-BÖHLER Pinze strappagessi	272
Z	
ZAUFAL-JANSEN Pinza sgorbia	181

ORTHO PAEDICS

IMPLANTS AND INSTRUMENTS

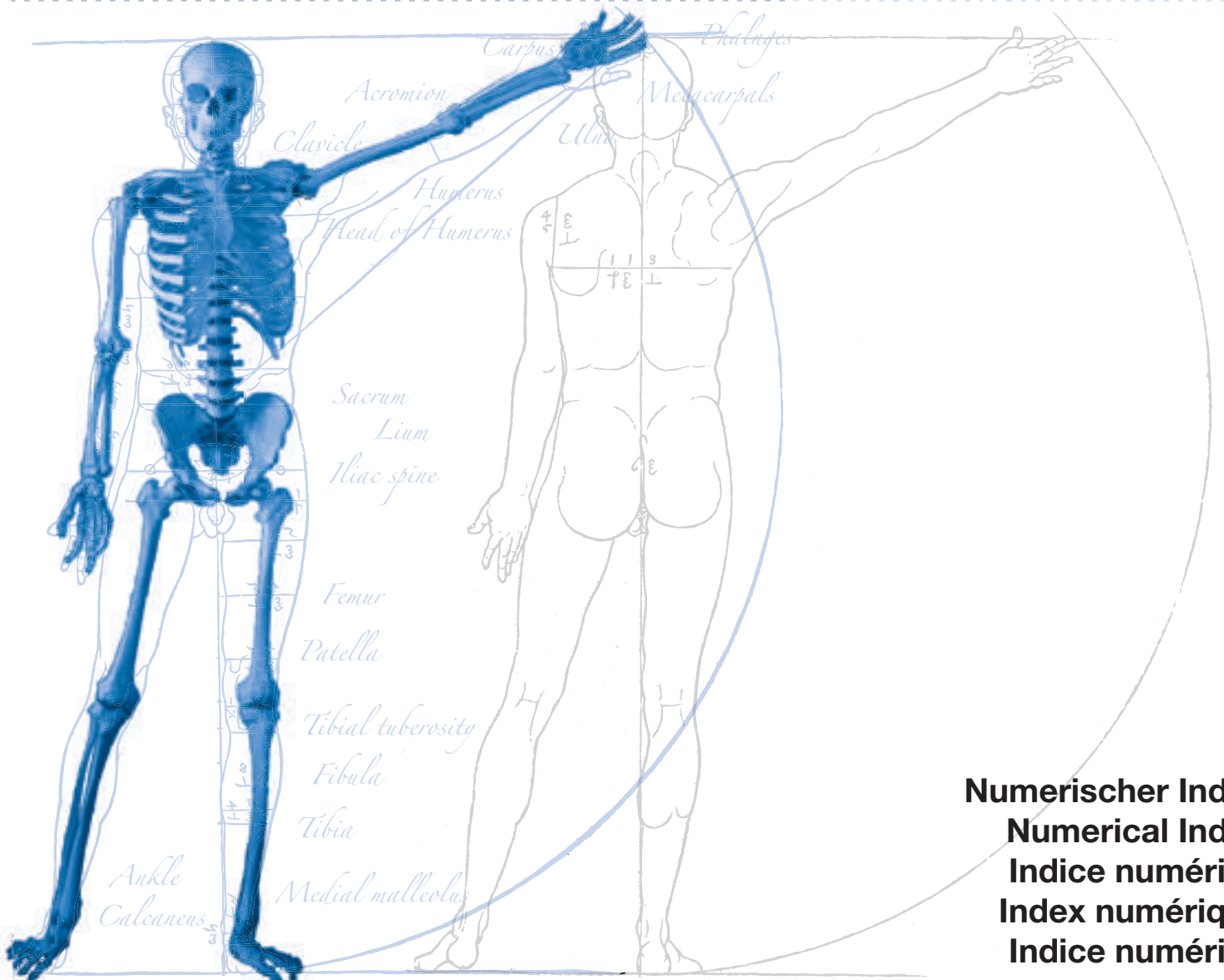

Numerischer Index
Numerical Index
Indice numérico
Indice numérique



Numerischer Index
Numerical Index
Indice numérico
Index numérique
Indice numerico

01.70.01	254	14.48.03	238	26.40.06	124	26.64.06P	131
01.70.02	254	14.48.04	237	26.42.03	124	26.64.13	39, 131
01.70.10	254	14.48.05	237	26.42.05	124	26.64.13P	39, 131
01.70.12	255	14.48.07	237	26.42.07	124	26.64.16	131
01.70.20	255	22.34.01	101	26.42.14	125	26.64.16P	131
01.72.13	256	26.01.11	118	26.42.15	125	26.64.26	59, 131
01.72.16	256	26.01.16	118	26.42.23	125	26.64.26P	59, 131
01.72.19	256	26.05.13	118	26.42.24	125	26.64.33	131
01.72.22	256	26.05.21	118	26.42.25	125	26.64.33P	131
01.73.15	257	26.05.22	118	26.42.56	125	26.64.73	131
01.75.11	257	26.05.23	118	26.42.58	125	26.64.75P	131
01.75.16	257	26.05.41	118	26.42.64	125	26.64.84	132
01.75.22	257	26.05.42	118	26.44.04	125	26.64.86P	132
14.20.09	242	26.05.43	118	26.44.22	126	26.64.94	132
14.20.10	242	26.10.10	119	26.44.23	126	26.64.96P	132
14.23.12	242	26.10.11	119	26.44.24	126	26.65.10	133
14.23.62	242	26.10.12	119	26.44.25	126	26.65.10P	133
14.23.66	242	26.10.13	119	26.44.28	126	26.65.13	133
14.24.10	241	26.10.14	119	26.45.04	126	26.65.13P	133
14.24.12	241	26.10.20	119	26.45.07	126	26.65.19	133
14.24.20	241	26.10.21	119	26.45.09	126	26.65.19P	133
14.24.22	241	26.10.22	119	26.45.12	126	26.65.25	133
14.25.10	241	26.10.23	119	26.47.32	126	26.65.25P	133
14.25.12	241	26.14.22	120	26.47.33	126	26.66.34	134
14.25.20	241	26.14.28	120	26.47.35	127	26.66.34P	134
14.25.22	241	26.14.50	120	26.47.38	127	26.66.35	134
14.26.10	241	26.15.01	118	26.48.01	127	26.66.35P	134
14.26.12	241	26.15.02	118	26.48.02	127	26.66.36	134
14.26.20	241	26.23.04	121	26.48.03	127	26.66.36P	134
14.26.22	241	26.24.04	121	26.48.04	127	26.67.27	134
14.26.72	243	26.24.05	121	26.50.58	127	26.67.27P	134
14.27.10	241	26.24.07	121	26.53.13	128	26.67.33	135
14.27.12	241	26.27.10	121	26.53.23	128	26.67.33P	135
14.27.20	241	26.27.12	121	26.53.33	128	26.67.34	135
14.27.22	241	26.27.57	121	26.53.41	128	26.67.34P	135
14.28.68	243	26.27.65	121	26.53.51	128	26.68.20	136
14.29.68	243	26.27.70	121	26.53.65	128	26.68.20P	136
14.30.11	243	26.29.07	122	26.54.10	129	26.69.20	136
14.30.13	243	26.29.10	122	26.54.15	129	26.69.20P	136
14.30.17	37, 58, 244	26.29.60	122	26.54.20	129	26.71.36	136
14.30.28	244	26.35.01	122	26.54.25	129	26.71.36P	136
14.30.65	244	26.35.02	122	26.56.06	129	26.71.38	136
14.30.76	244	26.35.03	122	26.56.12	129	26.71.38P	136
14.40.15	236	26.37.01	124	26.56.20	129	26.73.09	137
14.40.65	236	26.37.02	124	26.56.25	129	26.73.13	137
14.41.65	236	26.37.03	124	26.56.89	129	26.73.19	137
14.44.17	236	26.37.07	124	26.60.35	130	26.75.04	137
14.44.67	236	26.37.10	124	26.60.63	130	26.75.06	137
14.46.14	37, 237	26.37.12	123	26.62.01	130	26.75.08	137
14.46.15	237	26.37.90	123	26.62.02	130	26.76.01	138
14.48.01	238	26.37.95	123	26.64.06	131	26.76.02	138



Numerischer Index
Numerical Index
Indice numérico
Index numérique
Indice numerico

26.76.03	138	27.58.08	145	27.80.11	147	28.26.10	150
26.76.04	138	27.58.10	145	27.80.19	147	28.26.12	150
26.76.07	138	27.58.12	145	27.82.12	147	28.26.14	150
27.02.10	139	27.58.15	145	27.82.14	147	28.28.04	150
27.02.13	139	27.58.52	145	27.82.15	147	28.28.06	150
27.04.20	139	27.58.54	145	27.92.04	148	28.28.08	150
27.04.22	139	27.58.56	145	27.92.06	148	28.28.10	150
27.04.35	140	27.58.58	145	27.92.34	148	28.28.12	150
27.04.90	139	27.58.60	145	27.92.36	148	28.28.14	150
27.06.20	140	27.58.62	145	27.92.38	148	28.41.04	151
27.06.21	140	27.58.65	145	27.92.40	148	28.41.06	151
27.06.30	140	27.58.90	145	27.95.03	148	28.41.08	151
27.06.31	140	27.58.95	145	27.95.05	148	28.41.10	151
27.08.40	140	27.61.02	146	27.95.07	148	28.41.12	151
27.08.45	141	27.61.03	146	27.95.09	148	28.41.15	151
27.08.50	141	27.61.04	146	27.95.11	148	28.42.06	151
27.08.57	141	27.61.06	146	27.95.12	148	28.42.08	151
27.08.70	141	27.61.08	146	27.95.15	149	28.42.10	151
27.08.77	142	27.61.12	146	27.95.15P	149	28.42.12	151
27.09.19	142	27.61.13	146	27.95.16	149	28.42.15	151
27.09.25	142	27.61.14	146	27.95.16P	149	28.43.10	151
27.10.31	143	27.61.16	146	27.95.17	149	28.43.15	151
27.10.32	143	27.61.18	146	27.95.17P	149	28.43.20	151
27.10.33	143	27.61.62	146	27.95.20	149	28.43.25	151
27.10.50	143	27.61.63	146	27.95.20P	149	28.44.04	151
27.10.51	143	27.61.64	146	27.95.21	149	28.44.06	151
27.10.60	143	27.61.66	146	27.95.21P	149	28.44.08	151
27.10.61	143	27.61.68	146	27.95.22	149	28.44.10	151
27.10.70	144	27.61.72	146	27.95.22P	149	28.44.12	151
27.10.71	144	27.61.73	146	28.04.04	150	28.44.15	151
27.10.72	144	27.61.74	146	28.04.06	150	28.44.20	151
27.10.73	144	27.61.76	146	28.04.08	150	28.44.25	151
27.57.02	145	27.61.78	146	28.04.10	150	28.44.60	151
27.57.04	145	27.62.02	146	28.04.12	150	28.44.65	151
27.57.06	145	27.62.04	146	28.05.03	150	28.44.70	151
27.57.08	145	27.62.06	146	28.05.04	150	28.44.75	151
27.57.10	145	27.62.08	146	28.05.05	150	28.45.08	151
27.57.12	145	27.62.10	146	28.05.06	150	28.45.10	151
27.57.15	145	27.62.12	146	28.05.08	150	28.45.12	151
27.57.52	145	27.62.15	146	28.05.10	150	28.45.15	151
27.57.54	145	27.62.18	146	28.05.12	150	28.45.20	151
27.57.56	145	27.62.20	146	28.06.03	150	28.45.25	151
27.57.58	145	27.62.62	146	28.06.04	150	28.50.06	152
27.57.60	145	27.62.63	146	28.06.05	150	28.50.12	152
27.57.62	145	27.62.64	146	28.06.06	150	28.50.20	152
27.57.65	145	27.62.66	146	28.06.08	150	28.50.25	152
27.57.90	145	27.64.04	147	28.06.10	150	28.50.30	152
27.57.95	145	27.64.07	147	28.06.12	150	28.50.40	152
27.58.02	145	27.64.09	147	28.26.04	150	28.51.06	152
27.58.04	145	27.64.12	147	28.26.06	150	28.51.12	152
27.58.06	145	27.80.10	147	28.26.08	150	28.51.20	152



Numerischer Index
Numerical Index
Indice numérico
Index numérique
Indice numerico

28.51.25	152	28.62.02	153	28.65.75P	156	28.66.55	157
28.51.30	152	28.62.02P	153	28.65.80	156	28.66.55P	157
28.51.40	152	28.62.04	153	28.65.80P	156	28.67.04	158
28.51.56	152	28.62.04P	153	28.65.85	156	28.67.04P	158
28.51.62	152	28.62.06	153	28.65.85P	156	28.67.05	158
28.51.70	152	28.62.06P	153	28.65.91	155	28.67.05P	158
28.51.75	152	28.62.08	153	28.65.91P	155	28.67.06	158
28.51.80	152	28.62.08P	153	28.65.92	155	28.67.06P	158
28.51.90	152	28.62.10	153	28.65.92P	155	28.67.08	158
28.52.06	152	28.62.10P	153	28.65.93	155	28.67.08P	158
28.52.12	152	28.62.12	153	28.65.93P	155	28.67.10	158
28.52.20	152	28.62.12P	153	28.65.95	155	28.67.10P	158
28.52.25	152	28.62.15	153	28.65.95P	155	28.67.12	158
28.52.30	152	28.62.15P	153	28.66.04	157	28.67.12P	158
28.52.40	152	28.62.20	153	28.66.04P	157	28.67.15	158
28.52.56	152	28.62.20P	153	28.66.05	157	28.67.15P	158
28.52.62	152	28.64.07	154	28.66.05P	157	28.67.20	158
28.52.70	152	28.64.07P	154	28.66.06	157	28.67.20P	158
28.52.75	152	28.64.10	154	28.66.06P	157	28.67.22	158
28.52.80	152	28.64.10P	154	28.66.08	157	28.67.22P	158
28.52.90	152	28.64.12	154	28.66.08P	157	28.67.25	158
28.53.00	160	28.64.12P	154	28.66.10	157	28.67.34	158
28.53.02	160	28.64.15	154	28.66.10P	157	28.67.34P	158
28.53.04	160	28.64.15P	154	28.66.12	157	28.67.35	158
28.53.05	160	28.64.20	154	28.66.12P	157	28.67.35P	158
28.53.10	160	28.64.20P	154	28.66.15	157	28.67.36	158
28.53.16	160	28.64.25	154	28.66.15P	157	28.67.36P	158
28.53.25	160	28.64.25P	154	28.66.20	157	28.67.38	158
28.53.50	161	28.64.30	154	28.66.20P	157	28.67.38P	158
28.53.60	161	28.64.30P	154	28.66.22	157	28.67.40	158
28.53.70	161	28.65.07	154	28.66.22P	157	28.67.40P	158
28.54.05	161	28.65.07P	154	28.66.25	157	28.67.42	158
28.54.10	161	28.65.10	154	28.66.25P	157	28.67.42P	158
28.54.16	161	28.65.10P	154	28.66.34	157	28.67.45	158
28.54.25	161	28.65.12	154	28.66.34P	157	28.67.45P	158
28.61.02	153	28.65.12P	154	28.66.35	157	28.67.50	158
28.61.02P	153	28.65.15	154	28.66.35P	157	28.67.50P	158
28.61.04	153	28.65.15P	154	28.66.36	157	28.67.52	158
28.61.04P	153	28.65.20	154	28.66.36P	157	28.67.52P	158
28.61.06	153	28.65.20P	154	28.66.38	157	28.67.55	158
28.61.06P	153	28.65.25	154	28.66.38P	157	28.67.64	158
28.61.08	153	28.65.25P	154	28.66.40	157	28.67.64P	158
28.61.08P	153	28.65.30	154	28.66.40P	157	28.67.65	158
28.61.10	153	28.65.30P	154	28.66.42	157	28.67.65P	158
28.61.10P	153	28.65.55	156	28.66.42P	157	28.67.66	158
28.61.12	153	28.65.55P	156	28.66.45	157	28.67.66P	158
28.61.12P	153	28.65.60	156	28.66.45P	157	28.67.68	158
28.61.15	153	28.65.60P	156	28.66.50	157	28.67.68P	158
28.61.15P	153	28.65.65	156	28.66.50P	157	28.67.70	158
28.61.20	153	28.65.65P	156	28.66.52	157	28.67.70P	158
28.61.20P	153	28.65.75	156	28.66.52P	157	28.67.72	158



Numerischer Index
Numerical Index
Indice numérico
Index numérique
Indice numerico

28.67.72P	158	28.94.60	162	29.48.08	166	29.55.24	169
28.67.75	158	28.94.62	162	29.48.10	166	29.55.33	169
28.67.75P	158	28.94.65	162	29.48.12	166	29.55.42	169
28.67.80	158	28.94.70	162	29.48.14	166	29.55.50	169
28.67.80P	158	28.94.75	162	29.49.02	166	29.55.51	169
28.67.82	158	28.94.80	162	29.49.03	166	29.55.52	169
28.67.82P	158	28.94.90	162	29.49.04	166	29.55.53	169
28.67.85	158	28.94.94	162	29.49.05	166	29.55.54	169
28.71.06	159	28.94.99	162	29.49.06	166	29.55.55	169
28.71.09	159	29.10.10	163	29.49.07	166	29.55.56	169
28.71.12	159	29.10.11	163	29.49.08	166	29.56.24	169
28.71.15	159	29.10.12	163	29.49.10	166	29.56.24P	169
28.71.20	159	29.10.13	163	29.49.12	166	29.56.33	169
28.71.25	159	29.10.14	163	29.49.14	166	29.56.33P	169
28.71.30	159	29.13.01	163	29.51.24	167	29.56.42	169
28.71.56	159	29.13.02	163	29.51.33	167	29.56.42P	169
28.71.59	159	29.13.03	163	29.51.42	167	29.56.50	169
28.71.62	159	29.17.01	163	29.51.50	167	29.56.50P	169
28.71.65	159	29.17.02	163	29.51.51	167	29.56.51	169
28.71.70	159	29.17.03	163	29.51.52	167	29.56.51P	169
28.71.75	159	29.17.04	163	29.51.53	167	29.56.52	169
28.71.80	159	29.17.13	163	29.51.54	167	29.56.52P	169
28.72.06	159	29.17.14	163	29.51.55	167	29.56.53	169
28.72.09	159	29.18.05	164	29.51.56	167	29.56.53P	169
28.72.12	159	29.18.06	164	29.52.33	167	29.56.54	169
28.72.15	159	29.18.07	164	29.52.42	167	29.56.54P	169
28.72.20	159	29.18.08	164	29.52.50	167	29.56.55	169
28.72.25	159	29.20.01	165	29.52.51	167	29.56.55P	169
28.72.30	159	29.20.02	165	29.52.52	167	29.56.56	169
28.72.56	159	29.20.03	165	29.52.53	167	29.56.56P	169
28.72.59	159	29.20.04	165	29.52.54	167	29.63.33	170
28.72.62	159	29.20.05	165	29.53.24	168	29.63.42	170
28.72.65	159	29.24.01	165	29.53.33	168	29.63.50	170
28.72.70	159	29.24.02	165	29.53.42	168	29.63.51	170
28.72.75	159	29.24.51	165	29.53.50	168	29.63.52	170
28.72.80	159	29.24.52	165	29.53.51	168	29.67.06	170
28.94.04	162	29.40.33	165	29.53.52	168	29.67.15	170
28.94.06	162	29.40.42	165	29.53.53	168	29.67.24	170
28.94.08	162	29.40.50	165	29.53.54	168	29.67.33	170
28.94.10	162	29.40.51	165	29.53.55	168	29.67.42	170
28.94.12	162	29.40.52	165	29.53.56	168	29.67.50	170
28.94.15	162	29.40.53	165	29.53.64	168	29.67.51	170
28.94.20	162	29.40.54	165	29.53.73	168	29.67.52	170
28.94.25	162	29.40.55	165	29.53.82	168	29.68.42	164
28.94.30	162	29.40.56	165	29.53.90	168	29.68.50	164
28.94.40	162	29.48.02	166	29.53.91	168	29.68.51	164
28.94.44	162	29.48.03	166	29.53.92	168	29.68.52	164
28.94.50	162	29.48.04	166	29.53.93	168	29.69.51	170
28.94.54	162	29.48.05	166	29.53.94	168	29.69.52	170
28.94.56	162	29.48.06	166	29.53.95	168	29.69.53	170
28.94.58	162	29.48.07	166	29.53.96	168	29.80.10	171

**Numerischer Index**
Numerical Index
Indice numérico
Index numérique
Indice numerico

29.80.11	171	30.76.29	179	33.21.17	187	35.64.25	198
29.80.12	171	30.79.19	178	33.21.19	187	35.64.96	99, 198
29.80.62	171	30.79.59	178	33.21.22	187	35.75.17	198
29.80.96	172	31.04.02	179	33.50.15	187	35.75.25	199
29.83.10	171	31.04.03	179	33.51.15	187	35.75.26	199
29.83.11	171	31.05.02	179	33.56.18	188	35.75.27	199
29.83.12	171	31.05.03	179	33.57.18	188	35.76.15	39, 199
29.83.62	171	31.05.53	179	33.58.18	188	35.76.19	60, 199
29.83.72	172	31.05.83	180	33.59.17	188	35.76.24	84, 199
29.84.01	172	31.06.05	180	33.59.18	188	35.76.26	84, 199
29.84.02	172	31.06.25	180	33.70.27	189	35.76.28	84, 199
29.84.03	172	31.07.05	180	33.71.27	189	35.80.18	198
29.84.04	172	31.07.25	180	33.75.27	189	35.80.20	198
29.85.13	173	31.07.65	181	35.02.20	190	35.80.22	198
29.85.14	173	31.09.03	180	35.03.20	190	40.08.18	262
29.85.17	173	31.09.13	180	35.05.23	190	40.09.18	263
29.85.20	173	31.09.23	180	35.11.13	59, 191	40.13.24	263
29.87.01	173	31.09.93	181	35.11.14	191	40.20.14	262
29.87.02	173	31.11.04	181	35.11.17	191	40.20.84	262
29.87.03	173	31.11.05	181	35.11.18	191	40.24.17	264
30.05.14	174	31.11.13	182	35.14.14	59, 192	40.25.09	265
30.07.14	174	31.30.23	182	35.14.16	192	40.25.11	265
30.07.15	174	31.30.24	182	35.14.22	84, 192	40.25.14	265
30.15.14	174	31.30.27	182	35.15.18	192	40.25.18	265
30.15.17	174	31.31.23	182	35.15.19	192	40.25.20	265
30.17.14	174	31.31.24	182	35.16.21	193	40.25.64	265
30.17.17	174	31.31.27	182	35.20.20	193	40.25.68	265
30.17.97	175	31.31.53	183	35.21.16	193	40.25.70	265
30.25.30	175	31.31.57	183	35.21.19	193	40.25.96	264
30.25.45	175	31.31.83	183	35.21.20	194	40.26.20	264
30.25.90	175	31.51.05	184	35.21.22	194	40.26.80	264
30.30.15	175	31.51.08	184	35.21.25	194	40.31.20	266
30.30.35	175	31.53.03	184	35.24.20	195	40.31.22	266
30.38.18	175	31.53.05	184	35.25.20	195	40.33.23	266
30.38.56	176	31.53.08	184	35.35.14	195	40.41.23	267
30.38.69	176	31.54.03	185	35.35.23	195	40.41.24	267
30.50.18	177	31.54.05	185	35.35.64	195	40.41.74	267
30.51.18	177	31.54.08	185	35.35.73	195	40.47.14	268
30.52.17	176	31.61.02	185	35.45.23	196	40.47.18	268
30.52.18	176	31.61.03	185	35.45.25	196	40.47.21	268
30.53.17	176	31.61.04	185	35.45.28	196	40.49.23	268
30.53.18	176	33.02.15	186	35.45.73	196	40.50.39	276
30.54.21	177	33.04.18	186	35.45.75	196	40.50.40	276
30.54.70	178	33.11.14	186	35.45.78	196	40.50.45	277
30.71.02	177	33.11.17	186	35.50.21	197	40.50.46	277
30.71.03	177	33.20.14	187	35.52.21	198	40.50.48	277
30.76.13	177	33.20.17	187	35.60.33	197	40.50.65	274, 276, 278
30.76.14	177	33.20.19	187	35.60.45	197	40.50.66	278
30.76.17	178	33.20.22	187	35.61.33	197	40.50.68	279
30.76.18	178	33.20.83	186	35.61.45	197	40.50.69	274, 276, 279
30.76.19	179	33.21.14	187	35.64.23	198	40.50.71	274, 276, 279



Numerischer Index
Numerical Index
Indice numérico
Index numérique
Indice numerico

40.50.72	279	75.22.64	209	75.70.14	216	75.74.26	218
40.50.73	279	75.22.65	209	75.70.15	216	75.74.52	218
40.50.74	278	75.22.66	209	75.70.17	216	75.74.53	218
40.50.81	274	75.22.67	209	75.70.18	216	75.74.54	218
40.50.82	274	75.22.68	209	75.70.19	216	75.74.56	218
40.53.22	268	75.22.69	209	75.70.20	216	76.01.02	231
40.53.23	269	75.23.50	30	75.70.21	216	76.01.03	231
40.53.73	269	75.23.55	44	75.70.22	216	76.01.04	231
40.55.20	269	75.23.78A	30	75.70.23	216	76.01.05	231
40.55.23	270	75.23.80	210	75.70.24	216	76.01.06	231
40.55.26	270	75.23.81	210	75.70.54	216	76.01.07	231
40.55.37	270	75.23.82	210	75.70.56	216	76.01.08	231
40.55.70	269	75.23.83	210	75.70.57	216	76.01.09	231
40.55.73	270	75.49.53	215	75.70.59	216	76.01.10	231
40.55.76	270	75.49.70	83	75.71.00	217	76.01.12	231
40.55.77	270	75.66.05	214	75.71.10	216	76.01.15	231
40.56.37	270	75.66.06	214	75.71.12	216	76.01.18	231
40.56.77	270	75.66.07	215	75.71.13	216	76.01.20	231
40.60.05	271	75.66.08	215	75.71.14	216	76.05.01	232
40.60.50	281	75.66.30	214	75.71.15	216	76.05.02	232
40.60.60	280	75.66.31	214	75.71.16	216	76.05.03	232
40.60.61	280	75.66.32	214	75.71.17	216	76.05.23	232
40.60.62	281	75.66.33	214	75.71.19	216	76.05.24	233
40.60.64	280, 281	75.66.34	214	75.71.20	216	76.05.27	233
40.60.65	280, 281	75.66.35	214	75.71.21	216	76.05.50	234
40.60.82	282	75.66.36	214	75.71.22	216	76.05.60	234
40.60.84	282	75.66.37	214	75.71.24	216	76.05.65	235
40.61.05	271	75.66.38	214	75.71.25	216	76.06.08	220
40.61.50	281	75.66.39	214	75.72.00	217	76.06.09	220
40.61.65	281	75.66.40	214	75.72.20	216	76.06.10	220
40.62.50	280, 281	75.66.41	214	75.72.22	216	76.06.11	220
40.62.65	281	75.66.42	214	75.72.24	216	76.06.12	220
40.63.05	271	75.66.43	214	75.72.26	216	76.06.13	220
40.66.05	271	75.66.44	214	75.72.28	216	76.06.14	220
40.70.27	272	75.66.45	214	75.72.30	216	76.06.15	220
40.75.23	272	75.66.46	214	75.72.32	216	76.06.16	220
40.81.18	272	75.66.47	214	75.72.34	216	76.06.17	220
40.81.24	272	75.66.48	214	75.72.36	216	76.06.18	220
44.35.15	211	75.66.49	214	75.73.00	217	76.06.19	220
44.37.15	211	75.70.00	217	75.73.28	216	76.06.20	220
44.37.20	211	75.70.02	216	75.73.29	216	76.06.22	220
44.37.30	211	75.70.03	216	75.73.32	216	76.06.25	220
44.37.50	211	75.70.04	216	75.73.34	216	76.06.40	220
44.38.05	212	75.70.05	216	75.73.36	216	76.06.58	220
44.38.10	212	75.70.06	216	75.73.37	216	76.06.59	220
44.38.30	212	75.70.07	216	75.73.39	216	76.06.61	220
60.00.30	212	75.70.08	216	75.73.41	216	76.06.62	220
75.22.60	209	75.70.09	216	75.73.43	216	76.06.63	220
75.22.61	209	75.70.10	216	75.74.22	218	76.06.64	220
75.22.62	209	75.70.11	216	75.74.23	218	76.06.65	220
75.22.63	209	75.70.12	216	75.74.24	218	76.06.66	220

**Numerischer Index**
Numerical Index
Indice numérico
Index numérique
Indice numerico

76.06.67	220	76.07.78	221	76.08.54	221	76.10.25	220
76.06.68	220	76.07.79	221	76.08.55	221	76.10.58	220
76.06.69	220	76.07.80	221	76.08.56	221	76.10.59	220
76.06.70	220	76.07.81	221	76.08.57	221	76.10.60	220
76.06.72	220	76.07.82	221	76.08.58	221	76.10.61	220
76.06.75	220	76.07.83	221	76.08.59	221	76.10.62	220
76.06.78	221	76.07.84	221	76.08.60	221	76.10.63	220
76.06.79	221	76.07.85	221	76.08.61	221	76.10.64	220
76.06.80	221	76.07.86	221	76.08.62	221	76.10.65	220
76.06.81	221	76.07.87	221	76.08.63	221	76.10.66	220
76.06.82	221	76.07.88	221	76.08.64	221	76.10.67	220
76.06.83	221	76.07.89	221	76.09.07	250	76.10.68	220
76.06.84	221	76.07.90	221	76.09.08	250	76.10.69	220
76.06.85	221	76.07.92	221	76.09.09	250	76.10.70	220
76.06.86	221	76.07.95	221	76.09.15	250	76.10.72	220
76.06.87	221	76.08.00	233	76.09.16	250	76.10.75	220
76.06.88	221	76.08.01	233	76.09.17	250	76.10.78	221
76.06.89	221	76.08.10	220	76.09.18	250	76.10.79	221
76.06.90	221	76.08.11	220	76.09.20	250	76.10.80	221
76.06.92	221	76.08.12	220	76.09.21	250	76.10.81	221
76.06.95	221	76.08.13	220	76.09.22	250	76.10.82	221
76.07.08	220	76.08.14	220	76.09.25	250	76.10.83	221
76.07.09	220	76.08.15	220	76.09.26	250	76.10.84	221
76.07.10	220	76.08.16	220	76.09.28	250	76.10.85	221
76.07.11	220	76.08.17	220	76.09.29	250	76.10.86	221
76.07.12	220	76.08.18	220	76.09.40	251	76.10.87	221
76.07.13	220	76.08.19	220	76.09.41	251	76.10.88	221
76.07.14	220	76.08.20	220	76.09.42	251	76.10.89	221
76.07.15	220	76.08.21	220	76.09.45	251	76.10.90	221
76.07.16	220	76.08.22	220	76.09.46	251	76.10.92	221
76.07.17	220	76.08.23	220	76.09.47	251	76.10.95	221
76.07.18	220	76.08.24	220	76.09.50	251	76.11.00	221
76.07.19	220	76.08.30	220	76.09.51	251	76.11.08	220
76.07.20	220	76.08.31	220	76.09.52	251	76.11.09	220
76.07.22	220	76.08.32	220	76.09.53	251	76.11.10	220
76.07.25	220	76.08.33	220	76.09.70	251	76.11.11	220
76.07.58	220	76.08.34	220	76.09.72	251	76.11.12	220
76.07.59	220	76.08.35	220	76.10.08	220	76.11.13	220
76.07.60	220	76.08.36	220	76.10.09	220	76.11.14	220
76.07.61	220	76.08.37	220	76.10.10	220	76.11.15	220
76.07.62	220	76.08.38	220	76.10.11	220	76.11.16	220
76.07.63	220	76.08.39	220	76.10.12	220	76.11.17	220
76.07.64	220	76.08.40	220	76.10.13	220	76.11.18	220
76.07.65	220	76.08.41	220	76.10.14	220	76.11.19	220
76.07.66	220	76.08.42	220	76.10.15	220	76.11.20	220
76.07.67	220	76.08.43	220	76.10.16	220	76.11.22	220
76.07.68	220	76.08.44	220	76.10.17	220	76.11.25	220
76.07.69	220	76.08.50	221	76.10.18	220	76.11.30	220
76.07.70	220	76.08.51	221	76.10.19	220	76.11.58	220
76.07.72	220	76.08.52	221	76.10.20	220	76.11.59	220
76.07.75	220	76.08.53	221	76.10.22	220	76.11.60	220



Numerischer Index
Numerical Index
Indice numérico
Index numérique
Indice numerico

76.11.62	220	76.15.08	221	76.18.11	223	76.21.40	222
76.11.64	220	76.15.10	221	76.18.12	223	76.21.45	222
76.11.65	220	76.15.12	221	76.18.13	223	76.21.50	222
76.11.66	220	76.15.14	221	76.18.19	223	76.21.70	222
76.11.67	220	76.15.15	221	76.18.20	223	76.21.75	222
76.11.68	220	76.15.16	221	76.18.21	223	76.21.80	222
76.11.70	220	76.15.17	221	76.18.22	223	76.21.85	222
76.11.72	220	76.15.18	221	76.18.28	223	76.21.90	222
76.11.75	220	76.15.19	221	76.18.29	223	76.21.95	222
76.11.80	220	76.15.20	221	76.18.30	223	76.22.00	222
76.12.08	220	76.15.22	221	76.18.31	223	76.22.20	222
76.12.09	220	76.15.25	221	76.18.51	223	76.22.25	222
76.12.10	220	76.15.30	221	76.18.52	223	76.22.30	222
76.12.11	220	76.16.03	224	76.18.53	223	76.22.35	222
76.12.12	220	76.16.04	224	76.18.54	223	76.22.40	222
76.12.13	220	76.16.05	224	76.18.60	223	76.22.45	222
76.12.14	220	76.17.00	222	76.18.61	223	76.22.50	222
76.12.15	220	76.17.01	222	76.18.62	223	76.22.70	222
76.12.16	220	76.17.02	222	76.18.63	223	76.22.75	222
76.12.17	220	76.17.03	222	76.18.69	223	76.22.80	222
76.12.18	220	76.17.09	222	76.18.70	223	76.22.85	222
76.12.19	220	76.17.10	222	76.18.71	223	76.22.90	222
76.12.20	220	76.17.11	222	76.18.72	223	76.22.95	222
76.12.22	220	76.17.12	222	76.18.78	223	76.23.00	222
76.12.24	220	76.17.18	222	76.18.79	223	76.23.20	223
76.12.25	220	76.17.19	222	76.18.80	223	76.23.25	223
76.12.30	220	76.17.20	222	76.18.81	223	76.23.30	223
76.12.58	220	76.17.21	222	76.18.87	223	76.23.35	223
76.12.59	220	76.17.27	222	76.18.88	223	76.23.40	223
76.12.60	220	76.17.28	222	76.18.89	223	76.23.45	223
76.12.62	220	76.17.29	222	76.18.90	223	76.23.50	223
76.12.64	220	76.17.30	222	76.18.96	223	76.23.70	223
76.12.65	220	76.17.51	222	76.18.97	223	76.23.75	223
76.12.66	220	76.17.52	222	76.18.98	223	76.23.80	223
76.12.67	220	76.17.53	222	76.18.99	223	76.23.85	223
76.12.68	220	76.17.54	222	76.19.50	224	76.23.90	223
76.12.70	220	76.17.60	222	76.19.51	224	76.23.95	223
76.12.72	220	76.17.62	222	76.19.57	224	76.24.00	223
76.12.75	220	76.17.63	222	76.19.58	224	76.40.01	225
76.12.80	220	76.17.69	222	76.19.64	224	76.40.03	225
76.13.08	221	76.17.71	222	76.19.65	224	76.40.21	226
76.13.10	221	76.17.72	222	76.20.00	224	76.40.23	226
76.13.12	221	76.17.78	222	76.20.01	224	76.40.25	226
76.13.14	221	76.17.79	222	76.20.02	224	76.41.01	227
76.13.15	221	76.17.80	222	76.20.03	224	76.41.02	227
76.13.16	221	76.17.81	222	76.20.04	224	76.41.03	227
76.13.18	221	76.18.01	223	76.20.05	224	76.41.04	227
76.13.20	221	76.18.02	223	76.21.20	222	76.41.05	228
76.13.22	221	76.18.03	223	76.21.25	222	76.41.06	228
76.13.25	221	76.18.04	223	76.21.30	222	76.41.07	228
76.13.30	221	76.18.10	223	76.21.35	222	76.41.20	229



Numerischer Index
Numerical Index
Indice numérico
Index numérique
Indice numerico

76.41.23	229	76.50.79	283	77.11.24	205	708.00.06	4
76.41.29	229	76.50.80	287	77.11.34	205	708.00.07	4
76.41.41	225	76.50.81	287	77.11.42	206	708.00.08	4
76.41.42	225	76.51.10	286	77.11.65	206	708.00.09	4
76.41.50	228	76.51.11	286	77.11.93	207	708.00.10	4
76.41.55	228	76.51.20	288	77.12.04	207	708.00.11	4
76.44.01	230	76.51.21	288	77.12.06	207	708.00.12	4
76.44.03	230	76.51.60	289	77.12.51	208	708.00.13	4
76.44.05	230	76.51.61	289	77.12.52	208	708.00.14	4
76.44.15	222	76.55.17	200	77.12.54	102	708.00.15	4
76.44.16	222	76.59.15	200	78.03.01	200	708.00.16	4
76.44.20	222	76.59.21	200	78.03.05	231	708.00.17	4
76.44.21	222	76.59.22	200	78.03.07	231	708.00.18	4
76.45.10	238	76.69.15	288	78.35.03	201	708.00.19	4
76.45.15	238	76.69.20	288	78.35.05	201	708.00.20	4
76.45.18	239	76.69.25	288	78.35.07	201	708.01.00	5
76.45.19	58, 238	76.69.30	288	78.35.09	201	708.01.01	5
76.45.21	239	76.69.32	288	78.35.11	40, 60, 201	708.01.02	5
76.45.22	239	76.69.35	288	78.35.12	40, 60	708.01.03	5
76.45.25	239	76.69.40	288	78.35.13	40	708.01.04	5
76.45.26	239	76.69.45	288	78.35.55	201	708.01.05	5
76.45.27	239	76.69.50	288	78.84.01	42	708.01.06	5
76.45.29	240	76.69.60	288	78.84.02	42	708.01.07	6
76.45.30	240	77.02.14	258	78.84.13	43	708.01.08	6
76.45.43	245	77.02.23	258	78.84.15	43	708.01.09	6
76.45.47	245	77.04.29	258	78.84.17	43	708.01.10	6
76.45.55	247	77.04.70	258	78.84.19	43	708.01.11	7
76.45.60	247	77.05.35	258	78.84.21	43	708.01.12	7
76.45.73	245	77.05.39	259	78.84.23	43	708.01.13	8
76.45.75	247	77.05.40	259	78.84.25	43	708.01.14	9
76.45.79	248	77.05.62	258	78.84.27	43	708.01.15	9
76.45.80	248	77.05.68	258	78.84.29	43	708.01.16	8
76.45.81	248	77.05.74	259	78.84.31	43	708.01.17	7
76.45.85	246	77.05.76	259	78.84.33	43	708.01.18	8
76.50.00	284	77.05.78	259	78.84.35	43	708.01.19	9
76.50.01	284	77.05.92	259	78.84.37	43	708.25.04	3
76.50.10	285	77.05.98	259	78.85.11	44	708.25.05	3
76.50.11	285	77.09.50	260	240.25.14	265	708.25.06	3
76.50.12	285	77.10.05	202	240.25.18	265	708.30.02	2
76.50.13	285	77.10.10	202	240.25.20	265	708.30.03	2
76.50.14	285	77.10.20	202	240.25.96	264	708.30.04	2
76.50.15	285	77.10.50	202	240.26.20	264	708.30.05	2
76.50.16	285	77.10.60	202	240.31.20	266	708.30.06	2
76.50.17	285	77.10.65	203	240.41.24	267	708.30.08	2
76.50.18	285	77.10.71	203	351.64.01	39, 58, 84	708.30.10	2
76.50.19	285	77.10.72	203	708.00.00	4	708.30.12	2
76.50.30	284	77.10.81	204	708.00.01	4	708.30.14	2
76.50.31	284	77.10.82	204	708.00.02	4	708.30.50	292
76.50.70	283	77.10.95	204	708.00.03	4	708.35.02	2
76.50.71	283	77.11.10	205	708.00.04	4	708.35.03	2
76.50.77	283	77.11.18	205	708.00.05	4	708.35.04	2



Numerischer Index
Numerical Index
Indice numérico
Index numérique
Indice numerico

708.35.05	2	709.05.00	17	709.20.04	20	709.30.20	27
708.35.06	2	709.05.01	17	709.20.05	20	709.30.21	27
708.35.08	2	709.05.02	18	709.20.06	20	709.30.22	27, 111
708.35.10	2	709.06.00	18	709.20.07	20	709.30.23	10, 27, 44, 115
708.35.12	2	709.06.01	18	709.20.08	20	709.30.24	27
708.35.14	2	709.07.00	19	709.20.09	20	709.30.25	27
708.40.02	2	709.07.01	19	709.20.10	20	709.30.26	27
708.40.03	2	709.08.00	19	709.20.11	20	709.30.27	27
708.40.04	2	709.08.01	19	709.20.12	20	709.30.28	27
708.40.05	2	709.09.02	21	709.20.13	20	709.30.29	27
708.40.06	2	709.09.04	21	709.20.14	20	709.30.30	28
708.40.08	2	709.09.05	21	709.20.15	20	709.30.31	28, 52
708.40.10	2	709.09.06	21	709.20.16	20	709.30.32	27
708.40.12	2	709.09.07	21	709.20.17	20	709.30.33	27
708.40.14	2	709.09.08	21	709.27.01	25	709.30.34	27
708.45.02	2	709.09.09	21	709.27.02	25	709.30.35	38
708.45.03	2	709.09.10	21	709.27.03	25	709.30.36	38
708.45.04	2	709.09.12	21	709.27.04	25	709.30.38	38
708.45.05	2	709.10.03	21	709.27.05	25	709.30.40	12, 36, 56, 108, 112
708.45.06	2	709.10.04	21	709.27.06	25	709.30.41	36
708.45.08	2	709.10.05	21	709.27.07	25	709.30.42	32
708.45.10	2	709.10.06	21	709.27.08	25	709.30.43	27
708.45.12	2	709.10.07	21	709.27.09	25	709.30.44	27
708.45.14	2	709.10.08	21	709.27.10	25	709.30.45	28
708.50.02	2	709.11.03	22	709.27.11	25	709.30.50	293-295
708.50.03	2	709.11.04	22	709.27.12	25	710.00.00	25, 49, 89, 105
708.50.04	2	709.11.05	22	709.27.13	25	710.00.02	46
708.50.05	2	709.11.06	22	709.27.14	25	710.00.03	46
708.50.06	2	709.11.07	22	709.27.15	25	710.00.04	46
708.50.08	2	709.11.08	22	709.27.16	25	710.00.05	46
708.50.10	2	709.12.00	22	709.27.17	25	710.00.06	46
708.50.12	2	709.12.01	22	709.27.18	25	710.00.07	46
708.50.14	2	709.13.00	23	709.30.00	35	710.00.08	46
708.95.06	3	709.13.01	23	709.30.01	35, 57	710.00.09	46
708.95.08	3	709.14.00	24	709.30.02	35, 57	710.00.10	46
708.95.10	3	709.14.01	24	709.30.03	36	710.00.12	46
708.95.12	3	709.14.07	23	709.30.04	34	710.00.14	46
708.95.14	3	709.15.01	16	709.30.05	29, 54	710.00.16	46
708.95.16	3	709.15.02	16	709.30.06	29	710.00.18	46
709.00.00	16, 20	709.15.03	16	709.30.07	29	710.01.02	46
709.00.20	14	709.15.04	16	709.30.08	29	710.01.03	46
709.01.02	14	709.15.05	16	709.30.09	29	710.01.04	46
709.01.03	14	709.15.06	16	709.30.10	30, 106	710.01.05	46
709.02.04	14	709.15.07	16	709.30.11	31, 53	710.01.06	46
709.03.05	15	709.15.08	16	709.30.12	31, 55	710.01.07	46
709.03.06	15	709.15.09	16	709.30.13	31, 55	710.01.08	46
709.04.03	17	709.15.10	16	709.30.14	95	710.01.09	46
709.04.04	17	709.15.11	16	709.30.15	32, 55	710.01.10	46
709.04.05	17	709.20.01	20	709.30.16	94	710.01.11	46
709.04.06	17	709.20.02	20	709.30.17	32	710.01.12	46
709.04.20	17	709.20.03	20	709.30.19	33, 56, 108		

**Numerischer Index**
Numerical Index
Indice numérico
Index numérique
Indice numerico

710.02.03	47	710.35.16	48, 88	710.40.03	49, 89	711.00.07	62
710.02.04	47	710.35.17	48, 88	710.40.04	49, 89	711.00.08	62
710.02.05	47	710.35.18	48, 88	710.40.05	49, 89	711.00.09	62
710.02.06	47	710.35.19	48, 88	710.40.06	49, 89	711.00.10	62
710.03.03	47	710.35.20	48, 88	710.40.07	49, 89	711.00.11	62
710.03.04	47	710.35.21	48, 88	710.40.08	49, 89	711.00.12	62
710.03.05	47	710.35.22	48, 88	710.40.09	49, 89	711.00.13	62
710.04.03	47	710.35.23	48, 88	710.40.10	49, 89	711.00.14	62
710.04.04	47	710.35.24	48, 88	710.40.11	49, 89	711.00.15	62
710.04.05	47	710.35.25	48, 88	710.40.12	49, 89	711.00.16	62
710.04.06	47	710.35.26	48, 88	710.40.13	49, 89	711.00.18	62
710.30.00	57	710.35.27	48, 88	710.40.14	49, 89	711.01.05	62
710.30.01	57	710.35.28	48, 88	710.40.15	49, 89	711.01.06	62
710.30.02	57	710.35.29	48, 88	710.40.16	49, 89	711.01.07	62
710.30.03	57	710.35.30	48, 88	710.40.17	49, 89	711.01.08	62
710.30.04	57	710.35.31	48, 88	710.40.18	49, 89	711.01.09	62
710.30.07	34, 56	710.35.32	48, 88	710.40.19	49, 89	711.01.10	62
710.30.08	53	710.36.01	48, 88	710.40.20	49, 89	711.01.11	62
710.30.09	53, 107	710.36.02	48, 88	710.40.21	49, 89	711.01.12	62
710.30.10	53	710.36.03	48, 88	710.40.22	49, 89	711.01.13	62
710.30.12	33, 56, 95	710.36.04	48, 88	710.40.23	49, 89	711.01.14	62
710.30.13	51	710.36.05	48, 88	710.41.01	49, 89	711.01.15	62
710.30.14	51	710.36.06	48, 88	710.41.02	49, 89	711.01.16	62
710.30.15	51	710.36.07	48, 88	710.41.03	49, 89	711.01.18	62
710.30.16	51	710.36.08	48, 88	710.41.04	49, 89	711.02.02	63
710.30.17	51, 93	710.36.09	48, 88	710.41.05	49, 89	711.02.03	63
710.30.18	51	710.36.10	48, 88	710.41.06	49, 89	711.02.04	63
710.30.19	51	710.36.11	48, 88	710.41.07	49, 89	711.02.05	63
710.30.20	51	710.36.12	48, 88	710.41.08	49, 89	711.02.06	63
710.30.21	51, 93	710.36.13	48, 88	710.41.09	49, 89	711.02.07	63
710.30.22	52	710.36.14	48, 88	710.41.10	49, 89	711.02.08	63
710.30.23	52	710.36.15	48, 88	710.41.11	49, 89	711.02.09	63
710.30.24	52	710.36.16	48, 88	710.41.12	49, 89	711.02.10	63
710.30.25	54, 80	710.36.17	48, 88	710.41.13	49, 89	711.02.11	63
710.30.26	54, 80	710.36.18	48, 88	710.41.14	49, 89	711.02.12	63
710.30.50	296-297	710.36.19	48, 88	710.41.15	49, 89	711.05.03	63
710.35.01	48, 88	710.36.20	48, 88	710.41.16	49, 89	711.05.04	63
710.35.02	48, 88	710.36.21	48, 88	710.41.17	49, 89	711.05.05	63
710.35.03	48, 88	710.36.22	48, 88	710.41.18	49, 89	711.05.06	63
710.35.04	48, 88	710.36.23	48, 88	710.41.19	49, 89	711.05.07	63
710.35.05	48, 88	710.36.24	48, 88	710.41.20	49, 89	711.05.08	63
710.35.06	48, 88	710.36.25	48, 88	710.41.21	49, 89	711.06.04	64
710.35.07	48, 88	710.36.26	48, 88	710.41.22	49, 89	711.06.06	64
710.35.08	48, 88	710.36.27	48, 88	710.41.23	49, 89	711.06.08	64
710.35.09	48, 88	710.36.28	48, 88	711.00.00	74, 110	711.07.04	64
710.35.10	48, 88	710.36.29	48, 88	711.00.01	73, 91, 92, 114	711.07.06	64
710.35.11	48, 88	710.36.30	48, 88	711.00.02	62	711.07.08	64
710.35.12	48, 88	710.36.31	48, 88	711.00.03	62	711.08.04	65
710.35.13	48, 88	710.36.32	48, 88	711.00.04	62	711.08.05	65
710.35.14	48, 88	710.40.01	49, 89	711.00.05	62	711.08.06	65
710.35.15	48, 88	710.40.02	49, 89	711.00.06	62	711.08.08	65



Numerischer Index
Numerical Index
Indice numérico
Index numérique
Indice numerico

711.09.05	65	711.19.13	70	711.45.17	71, 90	711.46.22	71, 90
711.09.06	65	711.30.00	82	711.45.18	71, 90	711.46.23	71, 90
711.10.07	66	711.30.01	83	711.45.19	71, 90	711.46.24	71, 90
711.10.09	66	711.30.02	83	711.45.20	71, 90	711.46.25	71, 90
711.10.11	66	711.30.03	83	711.45.21	71, 90	711.46.26	71, 90
711.10.13	66	711.30.04	83	711.45.22	71, 90	711.46.27	71, 90
711.10.15	66	711.30.06	12, 82, 96	711.45.23	71, 90	711.46.28	71, 90
711.11.07	66	711.30.07	78	711.45.24	71, 90	711.46.29	71, 90
711.11.09	66	711.30.08	78, 112, 116	711.45.25	71, 90	711.46.30	71, 90
711.11.11	66	711.30.09	10, 79	711.45.26	71, 90	711.46.31	71, 90
711.11.13	66	711.30.10	11, 79	711.45.27	71, 90	711.46.32	71, 90
711.11.15	66	711.30.11	79	711.45.28	71, 90	711.46.33	71, 90
711.12.05	67	711.30.12	11, 55, 81, 94, 111	711.45.29	71, 90	711.46.34	71, 90
711.12.07	67			711.45.30	71, 90	711.46.35	71, 90
711.12.09	67	711.30.13	81	711.45.31	71, 90	711.46.36	71, 90
711.12.11	67	711.30.14	81, 95	711.45.32	71, 90	711.46.37	71, 90
711.12.13	67	711.30.15	11, 82	711.45.33	71, 90	711.46.38	71, 90
711.13.05	67	711.30.16	94	711.45.34	71, 90	711.46.39	71, 90
711.13.07	67	711.30.17	12, 82, 95, 116	711.45.35	71, 90	711.46.40	71, 90
711.13.09	67	711.30.18	10, 76	711.45.36	71, 90	711.46.41	71, 90
711.13.11	67	711.30.19	76	711.45.37	71, 90	711.46.42	71, 90
711.13.13	67	711.30.20	10, 76	711.45.38	71, 90	711.46.43	71, 90
711.14.05	68	711.30.21	76	711.45.39	71, 90	711.46.44	71, 90
711.14.07	68	711.30.22	76	711.45.40	71, 90	711.46.45	71, 90
711.14.09	68	711.30.23	76	711.45.41	71, 90	711.46.46	71, 90
711.14.11	68	711.30.24	76, 93	711.45.42	71, 90	711.47.01	74
711.14.13	68	711.30.25	76	711.45.43	71, 90	711.47.02	74
711.15.05	68	711.30.26	76, 93	711.45.44	71, 90	711.47.03	74
711.15.07	68	711.30.27	77	711.45.45	71, 90	711.47.04	74
711.15.09	68	711.30.28	78	711.45.46	71, 90	711.47.05	74
711.15.11	68	711.30.29	10, 76, 93	711.46.01	71, 90	711.47.06	74
711.15.13	68	711.30.30	10, 77	711.46.02	71, 90	711.47.07	74
711.16.05	69	711.30.31	77	711.46.03	71, 90	711.47.08	74
711.16.07	69	711.30.32	54, 80	711.46.04	71, 90	711.47.09	74
711.16.09	69	711.30.50	298-300	711.46.05	71, 90	711.47.10	74
711.16.11	69	711.45.01	71, 90	711.46.06	71, 90	711.47.11	74
711.16.13	69	711.45.02	71, 90	711.46.07	71, 90	711.47.12	74
711.17.05	69	711.45.03	71, 90	711.46.08	71, 90	711.47.13	74
711.17.07	69	711.45.04	71, 90	711.46.09	71, 90	711.65.01	72, 92
711.17.09	69	711.45.05	71, 90	711.46.10	71, 90	711.65.02	72, 92
711.17.11	69	711.45.06	71, 90	711.46.11	71, 90	711.65.03	72, 92
711.17.13	69	711.45.07	71, 90	711.46.12	71, 90	711.65.04	72, 92
711.18.05	70	711.45.08	71, 90	711.46.13	71, 90	711.65.05	72, 92
711.18.07	70	711.45.09	71, 90	711.46.14	71, 90	711.65.06	72, 92
711.18.09	70	711.45.10	71, 90	711.46.15	71, 90	711.65.07	72, 92
711.18.11	70	711.45.11	71, 90	711.46.16	71, 90	711.65.08	72, 92
711.18.13	70	711.45.12	71, 90	711.46.17	71, 90	711.65.09	72, 92
711.19.05	70	711.45.13	71, 90	711.46.18	71, 90	711.65.10	72, 92
711.19.07	70	711.45.14	71, 90	711.46.19	71, 90	711.65.11	72, 92
711.19.09	70	711.45.15	71, 90	711.46.20	71, 90	711.65.12	72, 92
711.19.11	70	711.45.16	71, 90	711.46.21	71, 90	711.65.13	72, 92



Numerischer Index
Numerical Index
Indice numérico
Index numérique
Indice numerico

711.65.14	72, 92	711.67.20	73, 91	712.37.02	104	712.45.11	109
711.65.15	72, 92	711.67.21	73, 91	712.37.03	104	712.45.12	109
711.65.16	72, 92	711.67.22	73, 91	712.37.04	104	712.45.13	109
711.65.17	72, 92	712.35.01	104	712.37.05	104	712.45.14	109
711.65.18	72, 92	712.35.02	104	712.37.06	104	712.45.15	109
711.65.19	72, 92	712.35.03	104	712.37.07	104	712.45.16	109
711.65.20	72, 92	712.35.04	104	712.37.08	104	712.45.17	109
711.65.21	72, 92	712.35.05	104	712.37.09	104	712.45.18	109
711.65.22	72, 92	712.35.06	104	712.37.10	104	712.45.19	109
711.66.01	73, 91	712.35.07	104	712.37.11	104	712.45.20	109
711.66.02	73, 91	712.35.08	104	712.37.12	104	712.45.21	109
711.66.03	73, 91	712.35.09	104	712.37.13	104	712.45.22	109
711.66.04	73, 91	712.35.10	104	712.37.14	104	712.45.23	109
711.66.05	73, 91	712.35.11	104	712.37.15	104	712.45.50	111
711.66.06	73, 91	712.35.12	104	712.37.16	104	712.45.51	111
711.66.07	73, 91	712.35.13	104	712.37.17	104	712.45.53	111
711.66.08	73, 91	712.35.14	104	712.37.18	104	712.45.54	112
711.66.09	73, 91	712.35.15	104	712.37.19	104	712.45.55	112
711.66.10	73, 91	712.35.16	104	712.37.20	104	712.46.01	110
711.66.11	73, 91	712.35.17	104	712.37.21	104	712.46.02	110
711.66.12	73, 91	712.35.18	104	712.38.01	105	712.46.03	110
711.66.13	73, 91	712.35.19	104	712.38.02	105	712.46.04	110
711.66.14	73, 91	712.35.20	104	712.38.03	105	712.46.05	110
711.66.15	73, 91	712.35.21	104	712.38.04	105	712.46.06	110
711.66.16	73, 91	712.35.50	106	712.38.05	105	712.46.07	110
711.66.17	73, 91	712.35.51	106	712.38.06	105	712.46.08	110
711.66.18	73, 91	712.35.52	106	712.38.07	105	712.46.09	110
711.66.19	73, 91	712.35.53	107	712.38.08	105	712.46.10	110
711.66.20	73, 91	712.35.54	107	712.38.09	105	712.46.11	110
711.66.21	73, 91	712.36.01	105	712.38.10	105	712.46.12	110
711.66.22	73, 91	712.36.02	105	712.38.11	105	712.46.13	110
711.66.23	73, 91	712.36.03	105	712.38.12	105	712.46.14	110
711.67.01	73, 91	712.36.04	105	712.38.13	105	712.46.15	110
711.67.02	73, 91	712.36.05	105	712.38.14	105	712.46.16	110
711.67.03	73, 91	712.36.06	105	712.38.15	105	712.46.17	110
711.67.04	73, 91	712.36.07	105	712.38.16	105	712.46.18	110
711.67.05	73, 91	712.36.08	105	712.38.17	105	712.46.19	110
711.67.06	73, 95	712.36.09	105	712.38.18	105	712.46.20	110
711.67.07	73, 95	712.36.10	105	712.38.19	105	712.46.21	110
711.67.08	73, 95	712.36.11	105	712.38.20	105	712.46.22	110
711.67.09	73, 95	712.36.12	105	712.38.21	105	712.46.23	110
711.67.10	73, 95	712.36.13	105	712.45.01	109	712.47.01	109
711.67.11	73, 95	712.36.14	105	712.45.02	109	712.47.02	109
711.67.12	73, 95	712.36.15	105	712.45.03	109	712.47.03	109
711.67.13	73, 95	712.36.16	105	712.45.04	109	712.47.04	109
711.67.14	73, 91	712.36.17	105	712.45.05	109	712.47.05	109
711.67.15	73, 91	712.36.18	105	712.45.06	109	712.47.06	109
711.67.16	73, 91	712.36.19	105	712.45.07	109	712.47.07	109
711.67.17	73, 91	712.36.20	105	712.45.08	109	712.47.08	109
711.67.18	73, 91	712.36.21	105	712.45.09	109	712.47.09	109
711.67.19	73, 91	712.37.01	104	712.45.10	109	712.47.10	109



Numerischer Index
Numerical Index
Indice numérico
Index numérique
Indice numerico

712.47.11	109	712.70.16	113	712.73.07	114	713.30.00	93
712.47.12	109	712.70.17	113	712.73.08	114	713.30.01	93
712.47.13	109	712.70.18	113	712.73.09	114	713.30.02	93
712.47.14	109	712.70.19	113	712.73.10	114	713.30.03	101
712.47.15	109	712.70.20	113	712.73.11	114	713.30.04	101
712.47.16	109	712.70.21	113	712.73.12	114	713.30.05	98
712.47.17	109	712.71.01	114	712.73.13	114	713.30.06	98
712.47.18	109	712.71.02	114	712.73.14	114	713.30.07	98
712.47.19	109	712.71.03	114	712.73.15	114	713.30.08	99
712.47.20	109	712.71.04	114	712.73.16	114	713.30.09	100
712.47.21	109	712.71.05	114	712.73.17	114	713.30.10	99
712.47.22	109	712.71.06	114	712.73.18	114	713.30.11	100
712.47.23	109	712.71.07	114	712.75.50	115	713.30.12	100
712.48.01	110	712.71.08	114	712.75.51	115	713.30.13	96
712.48.02	110	712.71.09	114	712.75.54	116	713.30.14	96
712.48.03	110	712.71.10	114	713.00.03	86	713.30.15	97
712.48.04	110	712.71.11	114	713.00.04	86	713.30.16	97
712.48.05	110	712.71.12	114	713.00.05	86	713.30.17	97
712.48.06	110	712.71.13	114	713.00.06	86	713.30.18	102
712.48.07	110	712.71.14	114	713.00.07	86		
712.48.08	110	712.71.15	114	713.00.08	86		
712.48.09	110	712.71.16	114	713.00.09	86		
712.48.10	110	712.71.17	114	713.00.10	86		
712.48.11	110	712.71.18	114	713.00.11	86		
712.48.12	110	712.72.01	113	713.00.12	86		
712.48.13	110	712.72.02	113	713.00.13	86		
712.48.14	110	712.72.03	113	713.00.14	86		
712.48.15	110	712.72.04	113	713.00.15	86		
712.48.16	110	712.72.05	113	713.00.16	86		
712.48.17	110	712.72.06	113	713.00.18	86		
712.48.18	110	712.72.07	113	713.01.06	86		
712.48.19	110	712.72.08	113	713.01.08	86		
712.48.20	110	712.72.09	113	713.01.10	86		
712.48.21	110	712.72.10	113	713.01.12	86		
712.48.22	110	712.72.11	113	713.01.14	86		
712.48.23	110	712.72.12	113	713.01.16	86		
712.70.01	113	712.72.13	113	713.01.18	86		
712.70.02	113	712.72.14	113	713.02.03	87		
712.70.03	113	712.72.15	113	713.02.04	87		
712.70.04	113	712.72.16	113	713.02.05	87		
712.70.05	113	712.72.17	113	713.02.06	87		
712.70.06	113	712.72.18	113	713.02.07	87		
712.70.07	113	712.72.19	113	713.02.08	87		
712.70.08	113	712.72.20	113	713.02.09	87		
712.70.09	113	712.72.21	113	713.02.10	87		
712.70.10	113	712.73.01	114	713.02.11	87		
712.70.11	113	712.73.02	114	713.02.12	87		
712.70.12	113	712.73.03	114	713.02.13	87		
712.70.13	113	712.73.04	114	713.02.14	87		
712.70.14	113	712.73.05	114	713.02.15	87		
712.70.15	113	712.73.06	114	713.02.16	87		



Weitere Medicon Produkte
Further Medicon Products
Más productos de Medicon
D'autres produits de Medicon
Altri prodotti Medicon



neuro
SPINALIS

Instrumente für die spinale Neurochirurgie
Instruments for Spinal Neurosurgery
Instrumentos para la neurocirugía espinal
Instruments pour la neurochirurgie spinale
Strumenti per la neurochirurgia spinale



MEDICON
implantArt
OSTEOSYNTHESIS

Implantate für die Osteosynthese
Implants for the Osteosynthesis
Implantes para la osteosintesis
Implants pour l'ostéosynthèse
Impianti per la osteosintesi

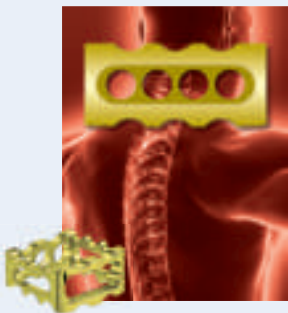

mediCage
Cervical

Implantate für die Halswirbelsäule
Implants for Cervical Spine
Implantes para la columna cervical
Implants pour le rachis cervical
Impianti per la colonna cervicale



MEDICONTAINER
CONTAINER system

Container-Systeme
Container systems
Sistema de contenedores
Systèmes de containers
Sistemi di contenitori



||| CMF

||| SURGICAL

||| NEURO+SPINE

Medicon eG

Gänsäcker 15
D-78532 Tuttlingen

P. O. Box 44 55
D-78509 Tuttlingen

Tel.: +49 (0) 74 62 / 20 09-0
Fax: +49 (0) 74 62 / 20 09-50

E-Mail: sales@medicon.de
Internet: www.medicon.de

Germany

450.00.63

medicon[®]

||| SURGICAL

